

LIGHTING CATALOGUE 2024-25



GEWISS

THE GROUP

Founded in 1970 based on the revolutionary insight into the use of technopolymer in electrical systems and guided by values of integrity, a culture of excellence, and sustainability, GEWISS is now the leading Italian company in the electro-technical sector. Continuous investments in research and development, employee training, and the enhancement of production facilities have positioned the company as a key player in the market for solutions and services in home & building automation, energy protection and distribution, electric mobility, and intelligent lighting.

The year 2023 marks a significant milestone in the Group's growth journey with the acquisition of PERFORMANCE iN LIGHTING, a historic leader in the lighting industry.

All the proposals featured in this catalog are designed and produced to meet every lighting need, representing the perfect synthesis of aesthetic design and technical performance. The constant drive towards innovation, a hallmark of the entire Group's history, further positions lighting solutions as a solid global reference in the world of design and architecture.

Made iN

With over 2,200 employees, the GEWISS Group is positioned as an international entity, with manufacturing sites, commercial branches, agencies, and distributors in over 100 countries worldwide.

The headquarters are located in Cenate Sotto (BG), while production facilities are situated in Italy, Germany, France, Portugal, Belgium, and the United States.

All products under the GEWISS brands are conceived, designed, engineered, and tested in the Group's facilities, using only components from certified brands.



Warranty

Focus on quality, safety and durability are the essential objectives of the GEWISS Group.

All products are covered by a 5-year warranty, provided that they are installed, maintained and used according to the instructions and information contained in the catalogue or on the web.

Consumable materials, such as lamps, starters, and electronic ignitors and reactors, emergency-units and batteries which are compliant with warranty regulations issued by the European Directive on the subject, are not included in the warranty.

To consult the full text of our warranty, please go to the website www.performanceinlighting.com



Clear conditions

In order to always provide customers with clear, complete information, PERFORMANCE iN LIGHTING has decided to provide the data pertaining to its LED luminaires in the following ways:

- Nominal lumen indicate the luminous flux produced by the LED source according to indications by the manufacturer of the LEDs used in the luminaire. Sometimes this is an average value derived from the range indicated by the producer.
- Real lumen indicate the luminous flux output of the luminaire. The real flux is therefore lower than the nominal flux because it depends on the luminaire's thermal regime and the use of reflectors, diffusers, screens or lenses to direct the light.
- Wattage drawn indicated in the table includes not only absorption by the LED light source, but also driver's loss from other electronic components of the luminaire. We then indicate the total amount of energy actually consumed by the luminaire as a whole.

With this information, PERFORMANCE iN LIGHTING aims to help creating more clarity in this sector, the LED luminaire industry, where it is sometimes difficult to interpret information and compare products.

Light Collections

Each light collection has its proper specific needs. The company operates the whole of its product range via seven application areas which cover the main light collections through an in-depth analysis to provide proper lighting solutions.



Technical
indoor



Office



Industrial



Residential



Architectural



Sports and Area



Urban and Street

Technical indoor

Recessed spotlights

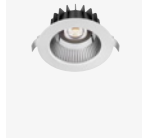

4
ELIA AL S2



4
ELIA AL M2

Wall / Ceiling surface



6
ELIA CL

Downlights



8
ELIA DL

Office

Ceiling recessed



12
ELIA PL M1 1200



14
ELIA PL M2 600



16
ELIA PL M3 625



18
ELIA PL IP65 M1
1200

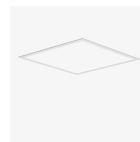

20
ELIA PL IP65 M2
600

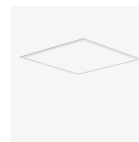

22
ELIA PL IP65 M3 625



24
ELIA PL BACKLIT
M1 1200

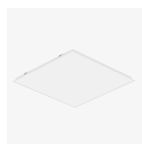

26
ELIA PL BACKLIT
M2 600

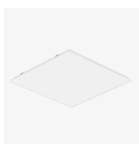

28
ELIA PL BACKLIT
M3 625



30
VISIO [16] M1 1200



32
VISIO [16] M2 600



34
VISIO [16] M3 625

Industrial

Hi-bay / low-bay



38
SMART [4] 1M



44
SMART [4] 2M



50
SMART [4] 4M



56
SMART [4] SPECIAL
VERSIONS



61
ESALITE HB



66
ELIA HL

Surface weatherproofs



68
SMART [3] PLUS



80
SMART [3]



84
SMART [3]E

Technopolymer + FV
| PMMA - PC

Residential

Wall / Ceiling surface



Technopolymer

88
EXTRO

Bulkheads



90
ELIA EL

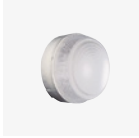

92
TONDA ES

Architectural

Wall surface

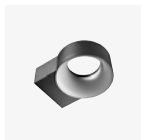

98
ELIA OL

Bollards



Aluminium
| Aluminium

96
ELIA BL

Sports and Area

Floodlighting

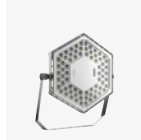

102
ESALITE FL



104
ELIA FL MINI XS1



106
ELIA FL MINI XS2



108
ELIA FL MINI XS3



110
ELIA FL S3



112
ELIA FL M3



114
ELIA FL L3



116
ELIA FL XL3



118
SMART IPROJE 1M



120
SMART IPROJE 2M



123
SMART IPROJE 4M



126
SMART IPRO 2.0 1M



130
SMART IPRO
2.0 2M

Sports / High Powered Floodlighting



135
SMART IPRO 2.0
2+2M



139
SMART IPRO 2.0
3X2M



142
STADIUM PRO 1M



147
STADIUM PRO 2M



151
STADIUM PRO 3M



154
SPATIUM PRO 1M



156
SPATIUM PRO 2M

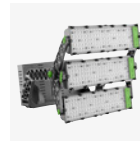

158
SPATIUM PRO 3M

Urban and Street

Area lighting



162
URBAN IO3

Aluminium
| Aluminium

Street lighting



164
ROAD IS MINI



170
ROAD IS MEDIUM



180
STREET IO3

Discover more

Seven light collections

Through a careful qualitative analysis of the lighting solutions, this catalog presents a wide range of fixtures across seven light collections.

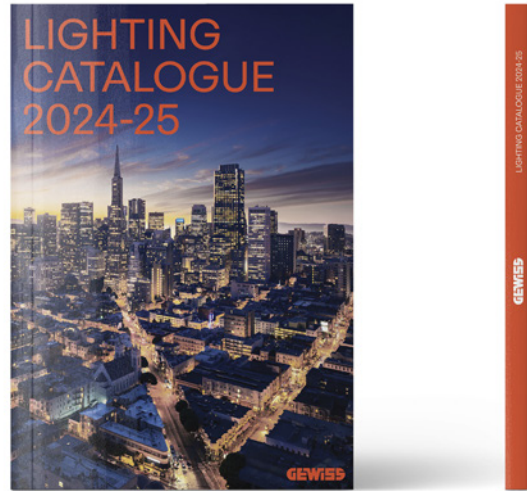

How to read product sheets

All informations presented in this catalogue may be subject to modifications. The company reserves the right to make any changes if necessary without prior notice. Partial or complete reproduction of this catalogue is prohibited.

Scan the QR-code for the latest information



Website

www.gewiss.com

www.performanceinlighting.com



WEBSITE

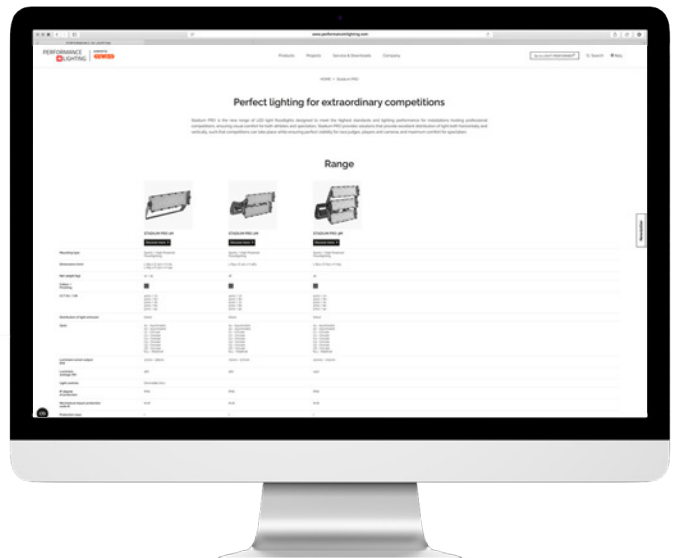

Light Controls



SMART - light control system 868 mhz

The system is based on a 868 MHz wireless platform and includes luminaires that are fitted with a highly intelligent device for complete management of light, a complete sensory range to detect the person and lighting levels, and dedicated control stations.

SMART allows to create systems that dynamically interact with the surrounding environment by modulating the flow level of luminaires based on natural light variations or on the specific need by detecting staff in the work place. The entire system is wireless controlled and needs no additional control line.

System flexibility is highest with a dedicated management software that allows to program the luminaires as required at any time, even after installation. To create or design systems with SMART, contact the Company.



Automatic power reduction

Luminaires are also available with automatic power reduction and with high-output electronic ballast already programmed to reduce the luminous flux by 50%. The power supply recognises the virtual night mid-point (e.g. midpoint of the switch-on time) and reduces the flux for a total of 8 hours, of which 2 hours before and 6 hours after.



Automatic power reduction with pilot command

Luminaire provided with dual-tap ballasts and switch device controlled from additional command line (pilot command).

By intervening on the device, the pilot command switches the power supply of the lamp from 100% to the reduced power value. In case of a power failure, when the installation is set at reduced power, the switch device always guarantees the re-switch of the lamp at 100% until stabilization is achieved, in order not to damage the lamp, and then goes back to the reduced power.

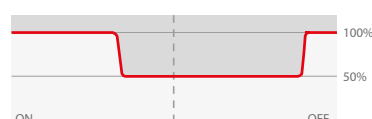

Colours

Natural Metals



BR-10/
Natural brass/
Glossy



INOX/
Stainless steel/
Glossy

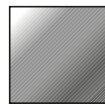

INOX/
Stainless steel/
Matt

Anodized | Metals

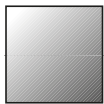

GR-EV1/
Anodised grey/
Matt

Painting | Metals / Technopolymer

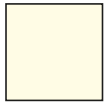

IVORY-10/
Ivory/
Textured



AN-96/
Anthracite gray/
Textured



BK-81/
Black/
Textured



RB-10
Rust/
Textured



BK-RAL9005/
Black RAL9005/
Glossy

Technopolymer



GR-94/
Metallic grey/
Textured

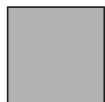

GR-RAL7035/
Grey RAL7035/
Matt



WH-87/
White/
Glossy



WH-87/
White/
Textured

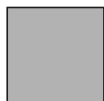

GR-RAL7035/
Grey RAL7035/

Painting | Metals



SL-10/
Silver/
Matt



BK-RAL9005/
Black RAL9005/
Textured



BK-RAL9005/
Black RAL9005/
Glossy



WH-RAL9003/
White RAL9003/
Glossy



WH-RAL9010/
White RAL9010/
Glossy



WH-RAL9010/
White RAL9010/
Textured

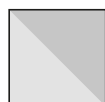

GR-20/
Metallic grey/
Glossy



GR-RAL9006/
Grey RAL9006/
Textured

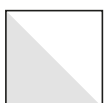

WH-RAL9016/
White RAL9016/
Glossy

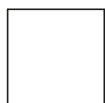

WH-RAL916/
White RAL9016/
Textured



BK-RAL 9017/
Black RAL9017/



















Graphite grey/
Graphite grey/















BlueGreen/
BlueGreen/

Pictograms













International protection marking

 IP 20 Protection against solid objects greater than 12 mm. No protection against water.	 IP 43 Protection against solid objects greater than 1,0 mm. Protection against spraying water.	 IP 54 Dust-protected. Protection against splashing water.	 IP 66 Total dust protection and total protection against hard splashing water.
 IP 23 Protection against entry of solid objects $\varnothing \geq 12$ mm and against rain.	 IP 44 Protection against solid objects greater than 1,0 mm. Protection against splashing water.	 IP 55 Dust-protected. Protection against water jets.	 IP 67 Dust-tight. Protection against the effects of temporary immersion.
 IP 40 Protection against solid objects greater than 1,0 mm. No protection against water.	 IP 45 Protection against solid objects greater than 1,0 mm. Protection against water jets.	 IP 64 Dust-tight. Protection against splashing water.	 IP 68 Fully dust protected. Protected against the effects of permanent immersion.
 IP 41 Protection against solid objects greater than 1,0 mm. Protection against vertically falling water drops.	 IP 50 Dust-protected. No protection against water.	 IP 65 Dust-tight. Protection against water jets.	 IK 10 Mechanical resistance to impacts of the diffuser



Mechanical characteristics

 WATER DRAIN Water drain	 Easing maintenance	 Through wiring connection	 QUICK Quick installation
 Side cable entry	 Adjustable louvre	 GLOW WIRE RESISTANCE Glow wire resistance	 WATER STOP Water stop
 Continuous mounted luminaire	 Luminaires bearing this symbol can be mounted on normally inflammable surfaces.	 HEAVY USE CONDITIONS Heavy use conditions	 LOOP THROUGH Loop through
 Devices with limited surface temperature			























Listings

 CE certified	 RCM certified	 Drive-over luminaire	 FULL CUT OFF Full cut-off
 ENEC certified	 Cool touch	 DIN EN 12464-1 conform	 ULR₁ ULR (Upward Light Ratio) nominal value, device not inclined.
 EAC certified	 Walk-over luminaire	 DIN 18032-3 conform	 CIE₃₋₉₅ 3° CIE flow code corresponding to 3 π / 2 sr (75.5°).
 ATEX certified			

Protection degree class

 CLASS I Class I luminaire. Luminaire with security earthing.	 CLASS II Class II luminaire. Reinforced or double insulated luminaire without earth protection.	 CLASS III Class III luminaire. SELV (Safety Extra Low-Voltage) luminaire which can only be fed by an extra low voltage supply (i.e. less than 50 Volts). Class III luminaires may not be earthed.
--	---	---

Electronic features

 Double switch	 Dimmable 1-10V	 MULTI POWER Power levels selectable during installation	 Fuse
 Dawn-dusk switch	 DALI Dimmable DALI	 SMART SMART! light monitor	 Hot restrike
 Constant light / presence control	 DMX DMX dimming function	 HCL Human Centric Lighting	 1h Emergency luminaire 1 h
 HF High frequency motion sensor	 TW Dynamic white	 Automatic derating	 2h Emergency luminaire 2 h
 IR Infrared motion sensor	 RGBW RGBW	 Pilot wire command derating	 3h Emergency luminaire 3 h
 CRI 90 Colour rendering index Ra ≥ 90	 MULTI WHITE Colour temperature selectable during installation		

Identifying and classifying our optics



The Group's luminaires offer different types of optics depending on project requirements.

The optic can be identified as the set of equipment designed to direct the light generated by a light source in a particular direction, thus determining the luminous emission of the luminaire itself.

The diagram below identifies the data that will be contained in subsequent pages, regarding the opening angle of the beam.

IMAX = maximum luminous intensity, i.e. the maximum intensity of the emitted light beam.

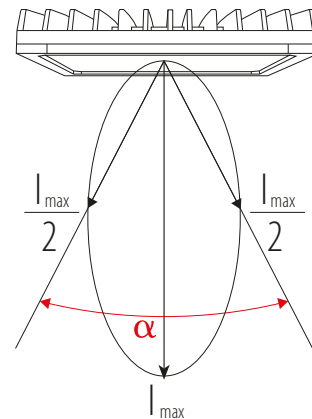
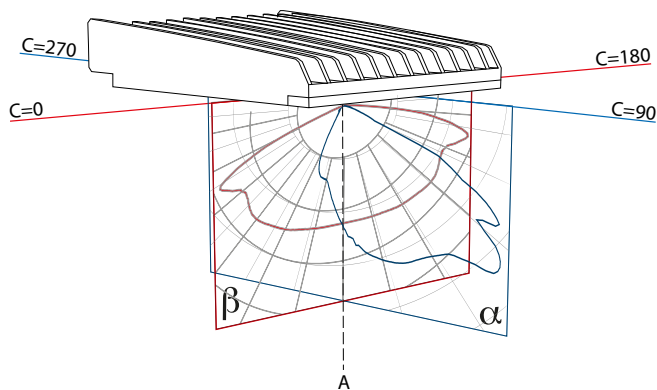

Depending on this luminous emission, the optics are classified in the following categories:

- S | Symmetric optics
- A | Asymmetric optics
- C | Circular optics
- ELL | Elliptical optics
- R | Grazing reflector optics
- SR | Road optics
- Z | Optics for pedestrian crossings

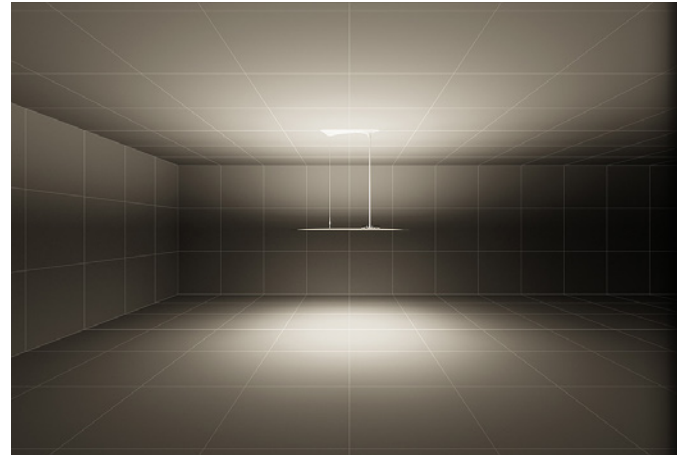
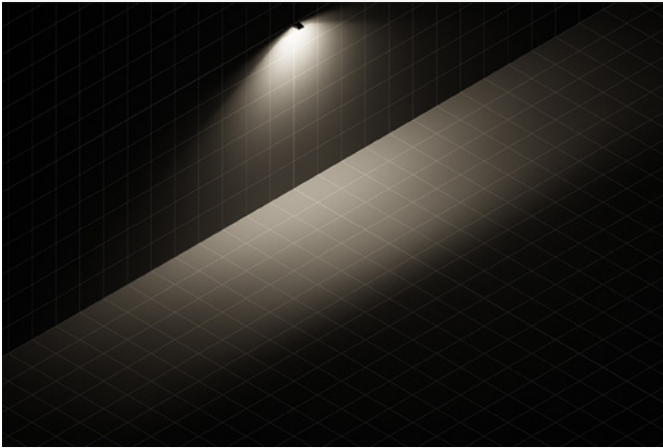

Symmetric optics

Symmetric optics are the ones with symmetric emission in relation to planes α and β .

The symmetry between the two planes may be either identical (in this case we are dealing with optics with square light distribution) or different (optics with rectangular light distribution).

Example

Symmetric optic code: S/xx

where:

S = Symmetric

xx = the abbreviated name of the opening angle

For example: S/I - S/M - S/W - S/EW

By convention, we consider the beam opening of plane α . Multiple optics within the same range of opening will be distinguished by inserting the numerical value of the beam opening at the end.

For example: S/W50 - S/W60

Symmetrical optics for series of luminaires with double light emission

This classification identifies the light emission typology of the luminaires inside those series that contain models with direct, indirect and / or combined light emission.

Symmetric optic name		
Mandatory indications	Additional indications	
Type of optic	Type of opening	Opening angle plane α
S	I	$0^\circ \div 20^\circ$
	M	$21^\circ \div 45^\circ$
	W	$46^\circ \div 75^\circ$
	EW	over 75°

Mandatory indications	Additional indications
Type of opening	Description
S1 S2	Includes all symmetrical optics from Narrow to Wide for Power LED
SN SM SW	Includes all symmetrical optics from Narrow to Wide for COB
ARRAY	Free distribution
MEDIUM	Medium beam diffuser
OPAL MICRO	Wide beam diffusers
SYMM	Symmetrical optic

Name of symmetrical optics for luminaires with double light emission			
Type of optic	Acronyms	Typology of light emission	
S	S/A	Direct symmetrical light	
	S/B	Mainly symmetrical direct light	
	S/C	Evenly direct - indirect symmetrical light	
	S/D	Mainly symmetrical indirect light	
	S/E	Indirect symmetrical light	

Identifying and classifying our optics

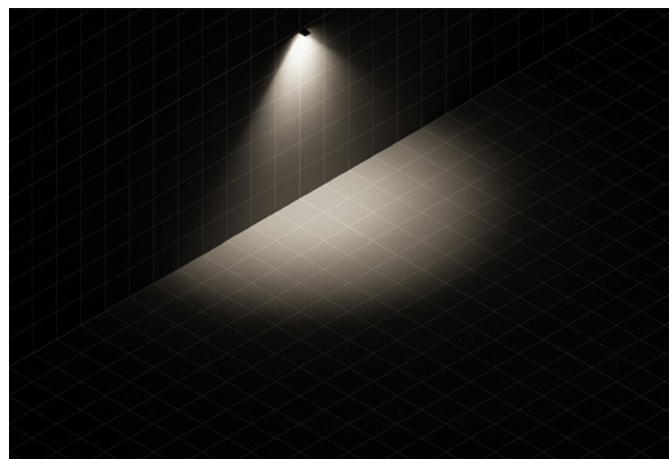
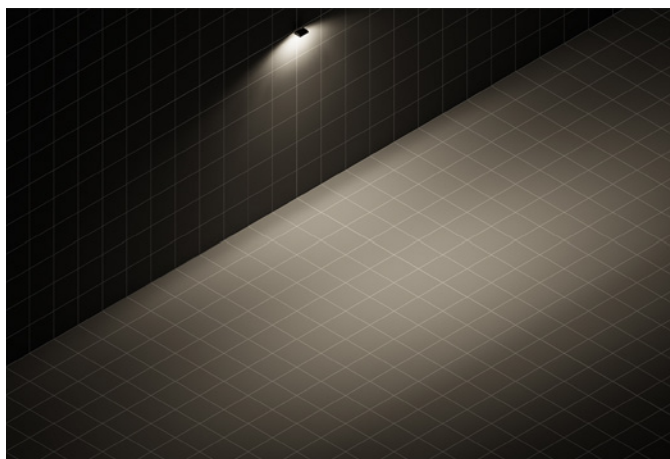

Asymmetric optics

Asymmetric optics generally have asymmetric light distribution on plane α with a point of maximum concentration. The axis passing through the point of maximum concentration and the point marked by the axis of the lamp is called the I_{max} axis. The light distribution on plane β , on the other hand, may be symmetric or asymmetric. An asymmetric optic may be symmetric in relation to one plane only.

Example

Asymmetric optic code: **Ayy/xx**

where:

A = Asymmetric

yy = numeric value of the I_{max} angle.

The I_{max} angle is the angle between axis **A** and the I_{max} axis.

xx = the abbreviated name of the opening angle

For example: **Ayy/I** – **Ayy/M** – **Ayy/W** – **Ayy/EW**.

By convention, the beam opening of plane α is considered.

For example:

A30/M = Asymmetric axis with I_{max} 30° and Medium opening

A45/I = Asymmetric axis with I_{max} 45° and Intensive opening

In the presence of multiple asymmetric optics with the same I_{max} value and same beam opening range, it will be necessary to distinguish them by adding the numeric value of the beam opening at the end.

For example: **A45/M25** - **A45/M40**

Asymmetric optic name

Mandatory indications		Additional indications	
Type of optic	I_{max} angle	Type of opening	Opening angle plane α
A	Numeric value of the I_{max} angle	I	0° ÷ 20°
		M	21° ÷ 45°
		W	46° ÷ 75°
		EW	over 75°
Mandatory indications		Additional indications	
Type of opening	Description		
A1 A2 A3	Includes all asymmetrical optics from Narrow to Wide for Power LED		
ASW ALW	Includes all asymmetrical optics from Narrow to Wide for COB		
ASYMM	Asymmetrical optic		

Circular optics

For circular optics, those optics are identified as optics that generate a luminous emission with a symmetry of revolution about the A axis as circular optics.

The opening angle of the beam is generally constant in all planes.

The reflectors generating these optics generally have a circular opening.

Example

Circular optic code: **C/xx**

where:

C = Circular

xx = the abbreviated name of the opening angle

For example: **C/I** - **C/M** - **C/IW** - **C/MW** - **C/EW**

Multiple optics within the same range of opening will be distinguished by inserting the numerical value of the beam opening at the end.

For example: **C/IW46** - **C/IW50**

Circular optic name

Mandatory indications		Additional indications
Type of optic	Type of opening	Opening angle α
C	I	0° ÷ 20°
	M	21° ÷ 45°
	IW	46° ÷ 60°
	MW	61° ÷ 75°
	EW	over 75°
Mandatory indications		Additional indications
Type of opening	Opening angle α	
C1	30° ÷ 45°	
C2	25° ÷ 30°	
C3	20° ÷ 25°	
C4	15° ÷ 20°	
C5	10° ÷ 15°	
C6	0° ÷ 10°	

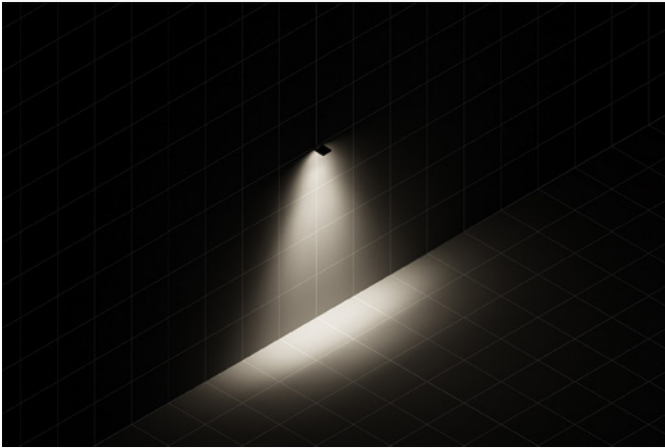

Elliptical optics

Elliptical optics are circular but differ from roto-symmetrical circular optics because the opening of the light beam on planes α and β is symmetric, but differs greatly between the two. The light distribution is highly elliptical.

Example

Elliptical optic code: E α x β

where:

E = Elliptical

α = Opening of the light beam on plane α expressed in degrees

β = Opening of the light beam on plane β expressed in degrees

For example: E 10°x45°

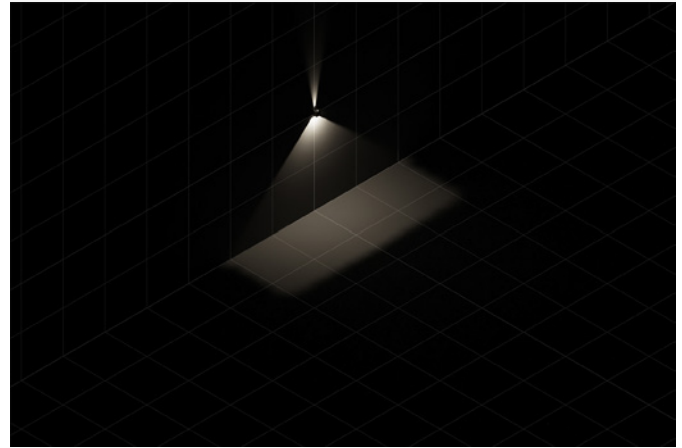

Grazing reflector optics

Grazing reflector optics stand out for their luminous emission that is typically parallel (grazing) to the installation surface (wall or ground).

These optics are primarily used for architectural lighting with the purpose of designing patterns of light and they rarely have a functional use.

A fundamental characteristic is the value of the α angle that identifies the value of the light beam aperture measured on the installation surface.

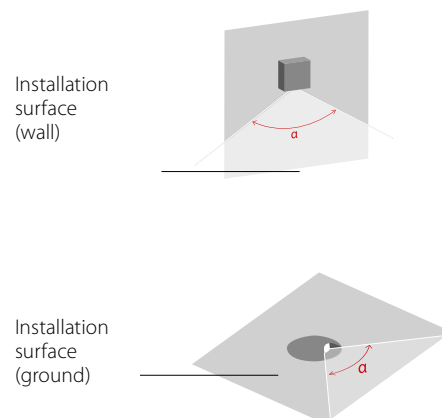

Identifying and classifying our optics

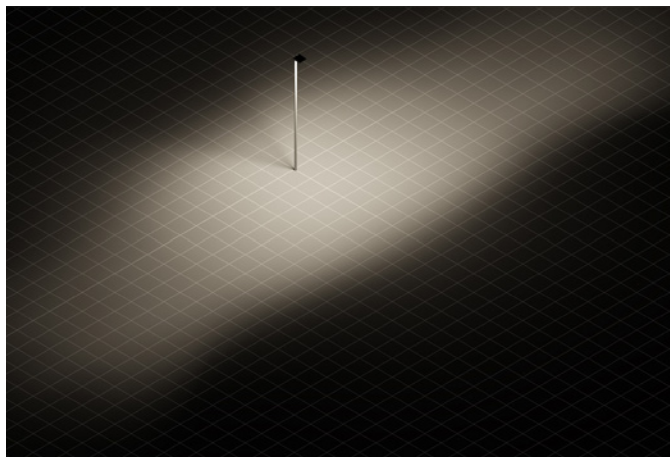

Road optics

Road optics are identified as the optics that have a very broad beam spread on the β plane (usually greater than 120°), with the point of maximum emission on one of the adjacent planes to the latter, up to a maximum of 45° .

Road lighting based on L/H ratio that can be found in road lighting systems, where:

- L: distance between the optical axes of the luminaire and the part of the area furthest from it with its own requirements.
- H: height of installation of the luminaire.

Example

Acronym of the road optics based on the L/H ratio: R/xxx

where:

R = road

xxx = L/H value (e.g. 100 = 1.00)

For example: R/075, R/100

Name of the road optics based on the L/H ratio:

Type of optic	Acronyms	Description
SR	075	Optic for L/H up to 0.75 ($0,5 \leq L/H \leq 0,875$)
	100	Optic for L/H of 1 ($0,875 \leq L/H \leq 1,125$)
	125	Optic for L/H of 1.25 ($1,125 \leq L/H \leq 1,375$)
	150	Optic for L/H of 1.5 ($1,375 \leq L/H \leq 1,625$)

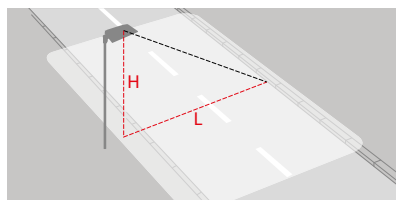

Mandatory indications	Additional indications
Acronyms	Description
HUGE	Optics for wide road geometries
WIDE	Optics for medium road geometries
ST1	Optics for medium-wide road geometries
CYCLE	Optics for pedestrian crossings

Road lighting - EN 13201-2 2015

This part of the European standard defines the performance requirements specified in the form of lighting categories for road lighting designed to satisfy the visual needs of road users and considers environmental aspects of road lighting.

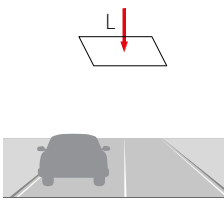
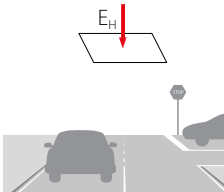
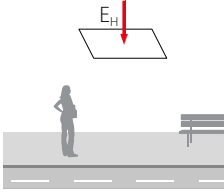
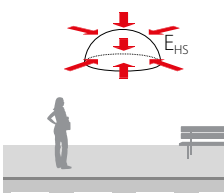
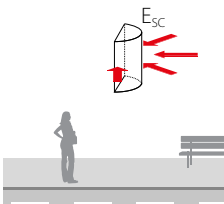
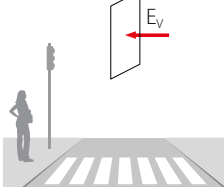
Class		Requirements					Recommended optic					
	M Motor traffic Roads with predominantly motor traffic. The lighting magnitude considered is average horizontal illuminance.		L (cd/m^2) (\geq)	U_o (\geq)	U_l (\geq)	fT_1 (%) (\leq)	R_g (\geq)	SR/075	SR/100	SR/125	SR/150	Z/R
		M1	2,00	0,40	0,70	10	0,35	-	-	-	-	-
		M2	1,50	0,40	0,70	10	0,35	-	✓	-	-	-
		M3	1,00	0,40	0,60	15	0,30	✓	✓	✓	✓	-
		M4	0,75	0,40	0,60	15	0,30	✓	✓	✓	✓	-
		M5	0,50	0,35	0,40	15	0,30	✓	✓	✓	✓	-
		M6	0,30	0,35	0,40	20	0,30	✓	✓	✓	✓	-
	C Motor traffic Conflict areas (crossroads and roundabouts) and residential streets. The lighting magnitude considered is average horizontal illuminance.		\bar{E} (lx) (\geq)	U_o (\geq)	fT_1 (%) (\leq)		SR/075	SR/100	SR/125	SR/150	Z/R	
		C0	50	0,40	15		-	✓	✓	✓	-	
		C1	30	0,40	15		-	✓	✓	✓	-	
		C2	20,0	0,40	15		-	✓	✓	✓	-	
		C3	15,0	0,40	20		✓	✓	✓	-	-	
		C4	10,0	0,40	20		✓	✓	-	-	-	
C5	7,50	0,40	20		✓	✓	-	-	-			
	P Pedestrian areas Pedestrian and/or cycling areas, residential streets, emergency lanes, car parks and pavements. The lighting magnitude considered is average horizontal illuminance.		\bar{E} (lx) (\geq)	E_{min} (lx) (\geq)	fT_1 (%) (\leq)		SR/075	SR/100	SR/125	SR/150	Z/R	
		P1	15,0	3,00	20		✓	✓	✓	✓	-	
		P2	10,0	2,00	25		✓	✓	✓	✓	-	
		P3	7,50	1,50	25		✓	✓	-	-	-	
		P4	5,00	1,00	30		✓	✓	-	-	-	
		P5	3,00	0,60	30		✓	-	-	-	-	
		P6	2,00	0,40	35		✓	-	-	-	-	
P7	-	-	-		✓	-	-	-	-			
	HS Pedestrian areas Pedestrian and/or cycling areas, residential streets, emergency lanes, car parks and pavements. The lighting magnitude considered is average hemispherical illuminance.		E_{HS} (lx) (\geq)	U_o (\geq)			SR/075	SR/100	SR/125	SR/150	Z/R	
		HS1	5,00	0,15			✓	✓	✓	✓	-	
		HS2	2,50	0,15			✓	✓	-	-	-	
		HS3	1,50	0,15			✓	-	-	-	-	
HS4	-	-			✓	-	-	-	-			
	SC Additional categories Additional category in pedestrian areas in which face recognition is required for security reasons. The lighting magnitude considered is specific minimum semi-cylindrical illuminance.		$E_{\text{SC,min}}$ (lx) (\geq)				SR/075	SR/100	SR/125	SR/150	Z/R	
		SC1	10,0				✓	✓	✓	✓	-	
		SC2	7,50				✓	✓	✓	✓	-	
		SC3	5,00				✓	✓	✓	✓	-	
		SC4	3,00				✓	✓	✓	✓	-	
		SC5	2,00				✓	✓	✓	✓	-	
		SC6	1,50				✓	✓	-	-	-	
		SC7	1,00				✓	-	-	-	-	
		SC8	0,75				✓	-	-	-	-	
SC9	0,50				✓	-	-	-	-			
	EV Additional categories Additional category in areas where attention must be paid to vertical elements, such as pedestrian crossings and conflict areas. The lighting magnitude considered is specific minimum vertical illuminance.		$E_{\text{V,min}}$ (lx) (\geq)				SR/075	SR/100	SR/125	SR/150	Z/R	
		EV1	50				-	-	-	-	✓	
		EV2	30				-	-	-	-	✓	
		EV3	10,0				-	-	✓	✓	✓	
		EV4	7,50				-	-	✓	✓	✓	
		EV5	5,00				-	-	✓	✓	✓	
EV6	0,50				-	-	✓	✓	✓			

Quality, tests, certifications

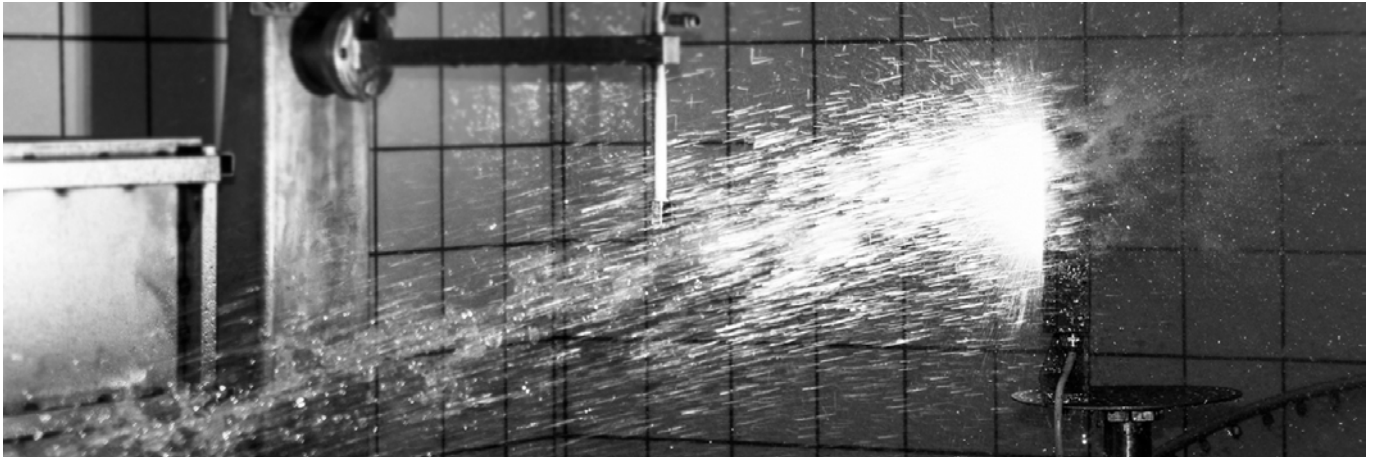

The company is oriented towards constant improvement and striving for the delicate balance between form and function. These aspects become luminaires and solutions that balance remarkable lighting performance with timeless aesthetics.

Performance, beauty, ease of installation and durability are objectives established at the initial product concept and intellectually carried through every design phase, paying particular attention to even the smallest construction detail.

All products are entirely designed in Italy, Germany and Belgium.

The group's technical offices for product development, design, 3D modelling, thermal simulation and study of fluid dynamics, and optics development all use the latest generation of professional software.

Management software is also used in which all the technical information is reported. These tools make it possible to optimize some phases of the general project management process, improving the broad productivity indices of the company.

The R&D department is equipped with modern 3D printers that can quickly produce a prototype of the designed part, reducing product development times.

Through continuous training, highly competent staff, and instrumentation supplied in its laboratories, the company can now independently perform almost all of the tests required by national and international regulations.

All lighting fixtures manufactured must comply with the strictest safety, quality, and durability regulations. To this end, the company has invested in internal laboratories that operate according to the international standard ISO 17025.

The laboratories are accredited with CTF STAGE 2 (Customers' Testing Facilities - Stage 2) certifications issued by IMQ and VDE.

They produce and certify the technical documentation necessary for the issue of the European ENEC certification.

The same laboratories are WTDP (Witness Test Data Program), qualified to conduct tests according to American standards (UL) to obtain product certification.

Within the laboratories, temperatures, electrical resistance, electrical insulation, mechanical resistance, protection against the entry of solids and liquids, electromagnetic compatibility and photometric distribution are checked to obtain a safe and efficient product.

Today, the Group has laboratories for electrical safety tests, photometric chambers with proprietary photogoniometers, integrating spheres, measuring optical flicker and stroboscopic effect, climatic chamber, salt spray test chamber and laboratories for electromagnetic compatibility tests.

The constant commitment to improving product quality and service has led the company to be certified by a quality system that complies with the ISO 9001-2015 standard for the whole production cycle, from design and production activities to logistics and marketing of its products.



All products which are subject to European Directive 2014/35/EU bear the mark CE.



The internal laboratory operates following the UNI EN ISO 17025:2005 standard, which allows PERFORMANCE IN LIGHTING to conduct all of the safety tests for its products. This guarantees the compliance of all products with the current European and extra-European standards.



The ENEC certified lighting fixtures are approved by a third-party certification body and comply with the European electrical safety standards. Companies that offer ENEC products apply a quality system in compliance with UNI EN ISO 9001.



The RCM Mark "Regulatory Compliance Mark", certifies that each individual electrical and electronic product complies with the mandatory safety requirements in Australia and New Zealand such as the electrical safety and electromagnetic compatibility.



The VDE mark documents the safety and conformity to standards of an electrical product with regard to electrical, mechanical, thermal, toxic and other hazards. It is awarded exclusively by the VDE test and certification institute (VDE-PZI). A manufacturer may only provide its products with the VDE mark after checking and issuing of a corresponding certificate.



The EAC mark certifies the conformity of the products with the regulations of the Eurasian customs' area; the mark allows the access to the marketplace of Russia, Belarus, Armenia, Kazakhstan, Kyrgyzstan.

Testing laboratory



All testing activities are supervised once a year by the Official Certification Bodies (IMQ S.p.A. and UL).

The laboratories are recognized by IMQ and VDE according to the CTFs STAGE 2 (Customers' Testing Facilities) procedures that release the ENEC label in compliance with the following standards:

IEC/EN 60598-1
Luminaires

IEC/EN 60598-2-1
Luminaires - Part 2-1: Particular requirements – Specification for fixed general purpose luminaires

IEC/EN 60598-2-2
Luminaires - Part 2-2: Particular requirements – Recessed luminaires

IEC/EN 60598-2-3
Luminaires - Part 2-3: Particular requirements – Luminaires for road and street lighting

IEC/EN 60598-2-4
Luminaires - Part 2-4: Particular requirements – Portable general purpose luminaires

IEC/EN 60598-2-5
Luminaires - Part 2-5: Floodlights

IEC/EN 60598-2-7
Luminaires - Part 2-7: Particular requirements – Portable luminaires for garden use

IEC/EN 60598-2-13
Luminaires - Part 2-13: Particular requirements - Ground recessed luminaires

IEC/EN 60598-2-18
Luminaires - Part 2-18: Particular requirements – Luminaires for swimming pools and similar applications

IEC/EN 62031
LED modules for general lighting - Safety specifications



Furthermore, the laboratories are recognized by UL according to the WTDP (Witness Test Data Program) for the release of the UL label in compliance with the following standards:

UL 1598
Luminaires

CSA C22.2 NO 250.0-08
Luminaires

UL 8750
Standard for Light Emitting Diode (LED) Equipment for Use in Lighting Products

CSA C22.2 NO 250.13-12
Light Emitting Diode (LED) Equipment for Lighting Applications

Within the laboratories, there is also an outfitted room (with the best EMI Receivers) for electromagnetic compatibility measurements and to ensure that the products are in compliance with the most important industry standards such as:

CISPR 15
Limits and methods of measurement of radio disturbance characteristics of electrical lighting and similar equipment

EN 55015
European Limits and methods of measurement of radio disturbance characteristics of electrical lighting and similar equipment

Quality, tests, certifications



Photometric laboratory

Considerable investments have also been made in photometric laboratories, which are recognized by UL and operate in accordance with the UNI EN 13032 standard.

This certification is synonymous with reliability and quality, as laboratories are subjected to inter-laboratory inspections and comparisons by the certifying body.

This result is that the company has the knowledge to supply the customer with highly reliable data, which translates theoretical projects into field results. The photometric laboratories are climate controlled to 25°C and are equipped with photogoniometers of various types (T2 and Type C), spectroradiometers, integrating spheres and Data Logger Multimeters with which it is possible to measure luminous flux and electrical parameters, temperature and all the colorimetry characteristics (CRI - CCT - Chromatic coordinates), as described in the reference standards listed below. Data measurements and processing are collected in compliance with the following standards:

UNI EN 13032-1

Light and Lighting – Measurement and presentation of photometric data of lamps and luminaires Part 1: Measurement and file format.

UNI EN 13032-4

Light and lighting. Measurement and presentation of photometric data of lamps and luminaires. Part 4: LED lamps, modules and luminaires.

IES LM-79-08

Approved method for the Electrical and Photometric Measurements of Solid-State Lighting Products.

To illuminate with led - photo-biological risk

With the coming onto the market of high power LED technology, usable both as common and signaling lighting, a confused marketing of poorly performing and unsafe products from a photo-biological viewpoint has taken place.

Therefore the Group chose to use high power LED from leading brands only.

On an international level a new standard has been fixed: EN62471 (IEC62471). This standard deals in a transversal way with the photo-biological risks of lighting sources and especially of LED devices and products using specific types of discharge lamps and LED light sources. A classification of GROUPS OF PHOTO-BIOLOGICAL RISKS under which luminaires may fall has been drawn.

The Groups of risks are defined as follows:

Group of Risk Nil:

The luminaires do not pose any photo-biological risks.

Group of Risk 1:

The luminaires do not cause photo-biological damage for the risk is cancelled by the common behavioral reaction of a person to the exposure to a light source.

Group of Risk 2:

The luminaires cannot cause photo-biological damage for the risk is cancelled by instinctive reaction of looking away from a very bright and strong light or from a thermal suffering.

Group of Risk 3:

The luminaires may cause photo-biological damage; risk is high even for a short or instant exposure. It is strongly advised to not use the luminaires for general lighting.

Production checks

PRODUCTION CHECKS

All products are subject to a vast number of accurate checks directly in the production line. Checks are done with control instruments that are checked and managed by the quality system procedure jointly with the indications reported on the "Minimum Values for Electrical Tests" List of the IEC/EN 60598-1 – Luminaires standard. This ensures the reliability and the compliance with security and performance of the product the Client expects.

Training of technical department

By constantly attending upgrade courses proposed by the industry associations and different certifying bodies, a fundamental importance is given to the specific training of the technical department. The company attends the meetings of the industry association (ASSIL) and is present in the 34D and 34A subcommittee of CEI (Italian Electro-technical Committee).



Environment

The concept of limited natural resources is given much consideration by the Group during product development.

The design choices, the entire production cycle up to packaging, transport, and all stages of the life of the fixtures placed on the market, including their recycling, aim to reduce potential environmental impacts.

The Group uses components and materials to save energy and respect the environment.

Intelligent control technologies are used, such as sensors that detect daylight and movement, software and electronic components for controlling products and their sources to obtain significant energy savings.

Furthermore, specially designed high-performance reflectors or lenses allow for optimal distribution of light where it is needed, avoiding waste and loss. The combination of efficient ballasts, optoelectronic light sources, intelligent sensors and highly complex reflectors results in durable, energy-efficient products with respect for the environment.



Ecodesign

New European directives on ecodesign and energy labelling of light sources for more sustainable lighting.

The European Community has set essential objectives that will lead to significant energy savings by 2030 and an increasingly diminished environmental impact by introducing the new UE 2019/2020 SRL (Ecodesign) and UE 2019/2015 ELR (Energy Labelling) regulations.

SRL REGULATION (Single Light Regulation UE 2019/2020 Ecodesign)

The Group designs and develops its lighting fixtures following the regulations, focusing on the environment and energy sustainability.

All the information required by the regulation is available on the free access website and product instruction sheets.

ELR REGULATION (Energy Labelling Regulation UE 2019/2015)

The company guarantees the registration of the light fixtures of its design and development in the EPREL database following the regulations.



RoHS compliant

The company is registered as a manufacturer with the German waste electrical equipment register EAR, in implementation of European Directive 2002/96/EC on Waste Electrical and Electronic Equipment (WEEE), under the following number: WEEE-Reg. No. DE 27756601. All electric and electronic equipment brought into circulation by the company is marked with the "crossed-out dustbin" symbol with a bar denoting the limit date for putting into circulation.

To our knowledge, our products contain no substances in concentrations or applications the putting into circulation of which in products is forbidden in accordance with the applicable requirements of Directive 2002/95/EC (RoHS). An environmental officer constantly examines further improvements, and constant staff training courses round off the complete catalogue of measures.



Interseroh recycling

The Group has concluded a contract with INTERSEROH for the proper recording, sorting and recycling of transport packaging. This ensures that packaging at our clients' premises is recorded by INTERSEROH partners, the packaging material is recycled and all requirements of the packaging directive are fulfilled.

Structure of the Group

The holding is composed by various manufacturing companies and many branches all over the world.
It is a unique industrial framework, its brands are distributed in more than one hundred countries throughout the world.

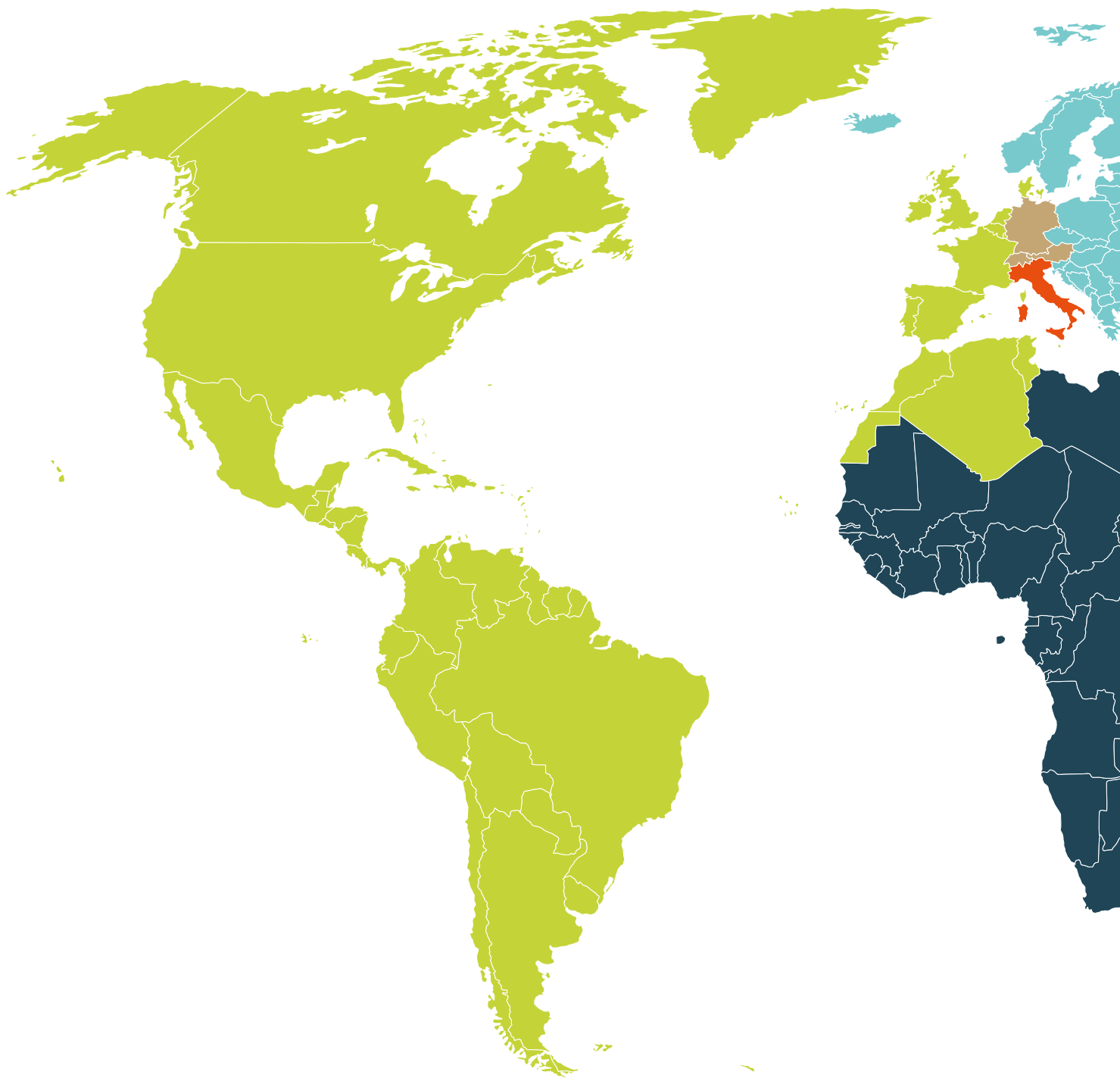

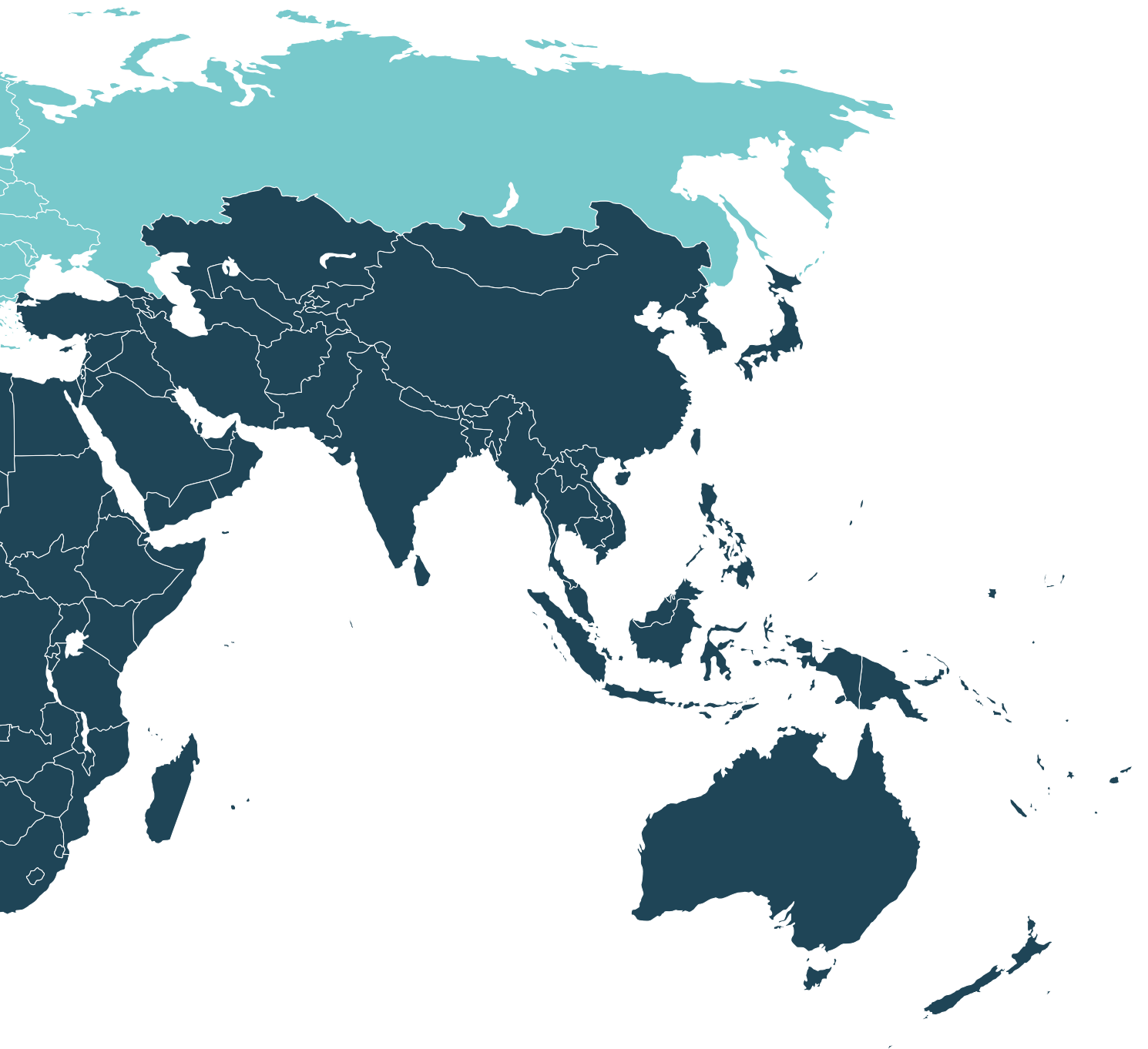

Technical indoor



Maximum versatility and integration: we develop indoor lighting systems that perfectly interact with architecture, favouring the balance between natural and artificial light. Our high-tech lighting solutions solve any spatial requirements, respecting the characteristics of each project.



ELIA AL



Scan the QR-code for the latest information

□ WH-RAL9016 / White RAL9016 /

- Flush-mounting LED device for accent lighting in commercial areas and offices
- This modular flush-mounting solution features a rotosymmetrical optic equipped with a passive heat removal system, in die-cast aluminium
 - It is composed of a white powder-coated die-cast aluminium frame and 2 different optics (36° and 60°) that guarantee a UGR of less than 19
 - Installation is quick and easy, thanks to the reduced weight of the device, the bayonet coupling and the simple wiring, with the connector located on the device and remote power supply included
 - External emergency kit with 3h autonomy available (to be ordered separately)

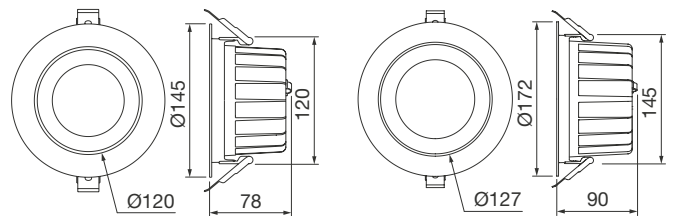
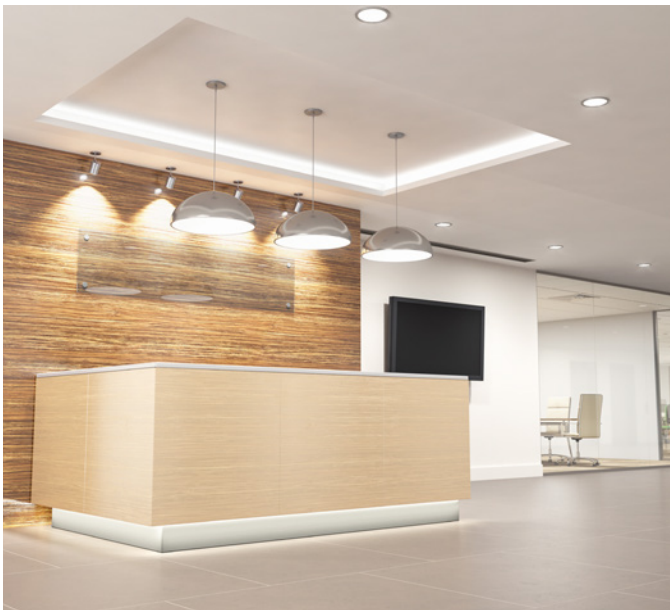

ELIA AL
S2 18W

ELIA AL
M2 25W

ELIA AL S2 18W 36°

IP40 - IK06 - 850 °C

LUMINAIRE WATTAGE (W)	CLASS	ENEC	DIN EN 12464-1	CRI	KELVIN	LIGHTSOURCE LUMEN OUTPUT (lm)	LUMINAIRE LUMEN OUTPUT (lm)	COLOUR / FINISH	PART NUMBER	UKCA
Power LED 220-240 V 50/60 Hz										
18	II	✓	-	90	4000	-	1800	<input type="checkbox"/>	GWF1410GG940	✓
18	II	✓	-	90	3000	-	1700	<input type="checkbox"/>	GWF1410GG930	✓
18	II	✓	-	80	4000	-	2000	<input type="checkbox"/>	GWF1410GG840	✓
18	II	✓	-	80	3000	-	1900	<input type="checkbox"/>	GWF1410GG830	✓
Power LED dimmable DALI - 220-240 V 50/60 Hz										
18	II	✓	-	90	4000	-	1800	<input type="checkbox"/>	GWF1411GG940	✓
18	II	✓	-	90	3000	-	1700	<input type="checkbox"/>	GWF1411GG930	✓
18	II	✓	-	80	4000	-	2000	<input type="checkbox"/>	GWF1411GG840	✓
18	II	✓	-	80	3000	-	1900	<input type="checkbox"/>	GWF1411GG830	✓



ELIA AL S2 18W 60°

IP40 - IK06 - 850 °C

LUMINAIRE WATTAGE (W)	CLASS	ENEC	DIN EN 12464-1	CRI	KELVIN	LIGHTSOURCE LUMEN OUTPUT (lm)	LUMINAIRE LUMEN OUTPUT (lm)	COLOUR / FINISH	PART NUMBER	UKCA
Power LED 220-240 V 50/60 Hz										
18	II	✓	-	90	4000	-	1900	<input type="checkbox"/>	GWF1410GH940	✓
18	II	✓	-	90	3000	-	1800	<input type="checkbox"/>	GWF1410GH930	✓
18	II	✓	-	80	4000	-	2100	<input type="checkbox"/>	GWF1410GH840	✓
18	II	✓	-	80	3000	-	2000	<input type="checkbox"/>	GWF1410GH830	✓
Power LED dimmable DALI - 220-240 V 50/60 Hz										
18	II	✓	-	90	4000	-	1900	<input type="checkbox"/>	GWF1411GH940	✓
18	II	✓	-	90	3000	-	1800	<input type="checkbox"/>	GWF1411GH930	✓
18	II	✓	-	80	4000	-	2100	<input type="checkbox"/>	GWF1411GH840	✓
18	II	✓	-	80	3000	-	2000	<input type="checkbox"/>	GWF1411GH830	✓



ELIA AL M2 25W 36°

IP40 - IK06 - 850 °C

LUMINAIRE WATTAGE (W)	CLASS	ENEC	DIN EN 12464-1	CRI	KELVIN	LIGHTSOURCE LUMEN OUTPUT (lm)	LUMINAIRE LUMEN OUTPUT (lm)	COLOUR / FINISH	PART NUMBER	UKCA
Power LED 220-240 V 50/60 Hz										
25	II	✓	-	90	4000	-	2500	<input type="checkbox"/>	GWF1410MG940	✓
25	II	✓	-	90	3000	-	2300	<input type="checkbox"/>	GWF1410MG930	✓
25	II	✓	-	80	4000	-	2700	<input type="checkbox"/>	GWF1410MG840	✓
25	II	✓	-	80	3000	-	2500	<input type="checkbox"/>	GWF1410MG830	✓
Power LED dimmable DALI - 220-240 V 50/60 Hz										
25	II	✓	-	90	4000	-	2500	<input type="checkbox"/>	GWF1411MG940	✓
25	II	✓	-	90	3000	-	2300	<input type="checkbox"/>	GWF1411MG930	✓
25	II	✓	-	80	4000	-	2700	<input type="checkbox"/>	GWF1411MG840	✓
25	II	✓	-	80	3000	-	2500	<input type="checkbox"/>	GWF1411MG830	✓



ELIA AL M2 25W 60°

IP40 - IK06 - 850 °C

LUMINAIRE WATTAGE (W)	CLASS	ENEC	DIN EN 12464-1	CRI	KELVIN	LIGHTSOURCE LUMEN OUTPUT (lm)	LUMINAIRE LUMEN OUTPUT (lm)	COLOUR / FINISH	PART NUMBER	UKCA
Power LED 220-240 V 50/60 Hz										
25	II	✓	-	90	4000	-	2600	<input type="checkbox"/>	GWF1410MH940	✓
25	II	✓	-	90	3000	-	2400	<input type="checkbox"/>	GWF1410MH930	✓
25	II	✓	-	80	4000	-	2800	<input type="checkbox"/>	GWF1410MH840	✓
25	II	✓	-	80	3000	-	2600	<input type="checkbox"/>	GWF1410MH830	✓
Power LED dimmable DALI - 220-240 V 50/60 Hz										
25	II	✓	-	90	4000	-	2600	<input type="checkbox"/>	GWF1411MH940	✓
25	II	✓	-	90	3000	-	2400	<input type="checkbox"/>	GWF1411MH930	✓
25	II	✓	-	80	4000	-	2800	<input type="checkbox"/>	GWF1411MH840	✓
25	II	✓	-	80	3000	-	2600	<input type="checkbox"/>	GWF1411MH830	✓



Optional accessories

DESCRIPTION	COLOR	PART NUMBER	UKCA
ELIA AL Emergency kit 3h		GWS2992	✓



GWS2992

ELIA CL

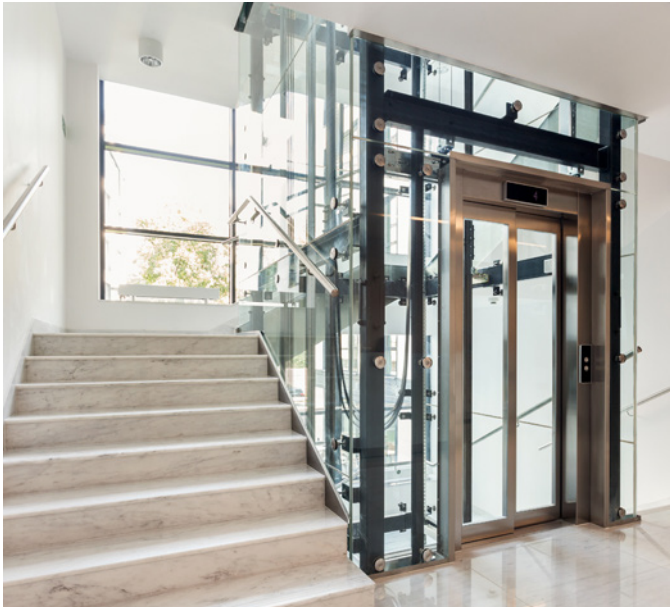

Scan the QR-code for the latest information

WH-RAL9016 / White RAL9016 /

LED device made from white polycarbonate designed for ceiling or surface mounting, ideal for lighting stairways, bathrooms/rest rooms and service areas, it is quick and easy to install, and features clean, minimalist lines

- Designed in two different sizes and power versions, it features a polycarbonate opal diffusing shell, a colour temperature of 4,000 K (neutral white) and a colour rendering index of more than 80
- It is also available in the Sensor version, with movement detection up to 8m, a radius of up to 120° and duration of 30 seconds, and in the Emergency version, the luminous flux is guaranteed for 3 hours of operation at 10%
- It has been designed to withstand temperature variations from -20°C to + 45°C, and offers protection from water and dust penetration of up to level IP54 and from shocks and impacts of up to level IK08
- Light and easy to handle, ELIA CL is easy to install thanks to the steel bracket on the back of the device for wall mounting, the quick-coupling terminal on the rear of the device for the electrical wiring and the bayonet locking mechanism for attaching the body of the light

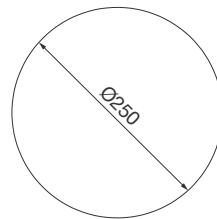

ELIA CL
S2 12W

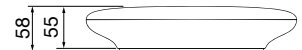
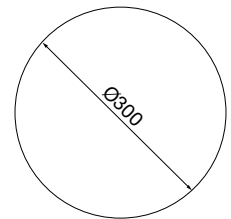

ELIA CL
M2 25W

ELIA CL S2 12W

IP20 - IK08 - 750 °C

LUMINAIRE WATTAGE [W]	CLASS	ENEC	DIN EN 12464-1	CRI	KELVIN	LIGHTSOURCE LUMEN OUTPUT [lm]	LUMINAIRE LUMEN OUTPUT [lm]	COLOUR / FINISH	PART NUMBER	UKCA
Power LED 220-240 V 50/60 Hz										
12	II	✓	-	80	4000	-	1300	<input type="checkbox"/>	GWF1310GA840	✓
12	II	✓	-	80	3000	-	1200	<input type="checkbox"/>	GWF1310GA830	✓
Power LED 220-240 V 50/60 Hz + HF Sensor										
12	II	✓	-	80	4000	-	1300	<input type="checkbox"/>	GWF1315GA840	✓
12	II	✓	-	80	3000	-	1200	<input type="checkbox"/>	GWF1315GA830	✓



ELIA CL M2 25W

IP20 - IK08 - 750 °C

LUMINAIRE WATTAGE [W]	CLASS	ENEC	DIN EN 12464-1	CRI	KELVIN	LIGHTSOURCE LUMEN OUTPUT [lm]	LUMINAIRE LUMEN OUTPUT [lm]	COLOUR / FINISH	PART NUMBER	UKCA
Power LED 220-240 V 50/60 Hz										
25	II	✓	-	80	4000	-	2600	<input type="checkbox"/>	GWF1310MA840	✓
25	II	✓	-	80	3000	-	2400	<input type="checkbox"/>	GWF1310MA830	✓
Power LED 220-240 V 50/60 Hz + HF Sensor										
25	II	✓	-	80	4000	-	2600	<input type="checkbox"/>	GWF1315MA840	✓
25	II	✓	-	80	3000	-	2400	<input type="checkbox"/>	GWF1315MA830	✓
Power LED - Emergency 3h - 220-240 V 50/60 Hz										
25	II	✓	-	80	4000	-	2600	<input type="checkbox"/>	GWF1314MA840	✓
Power LED - Emergency 3h - 220-240 V 50/60 Hz + HF Sensor										
25	II	✓	-	80	4000	-	2600	<input type="checkbox"/>	GWF1316MA840	✓



ELIA DL



Scan the QR-code for the latest information

□ WH-RAL9016 / White RAL9016 /

Flush-mounting LED downlight for lighting entrance areas, corridors and shared spaces

- Crafted from white power-coated die-cast aluminium with an opal diffusing shield
- Available in two power versions, with separate electronic power supply in the On/Off or DALI options provided as part of a kit, colour temperature of 4,000 K (neutral white) and colour rendering index of more than 80 or more than 90
- It was designed to withstand temperature variations from -20°C to +45°C, and offers protection from water and dust penetration of up to level IP54 and from shocks and impacts of up to level IK06
- Light and easy to handle, ELIA DL is easy to install thanks to the connector for the electrical wiring and the quick, simple fin-locking mechanism
- External emergency kit with 3h autonomy available (to be ordered separately)

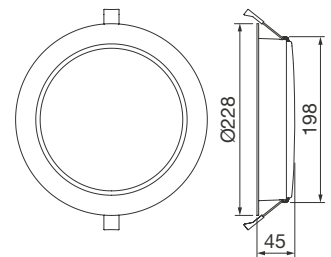

ELIA DL

ELIA DL M2 25W OPAL

IP40 - IK06 - 650 °C

LUMINAIRE WATTAGE [W]	CLASS	ENEC	DIR EN 12464-1	CRI	KELVIN	LIGHTSOURCE LUMEN OUTPUT [lm]	LUMINAIRE LUMEN OUTPUT [lm]	COLOUR / FINISH	PART NUMBER	UKCA
Power LED 220-240 V 50/60 Hz										
25	II	✓	-	90	4000	-	2400	<input type="checkbox"/>	GWF1510MA940	✓
25	II	✓	-	80	4000	-	2600	<input type="checkbox"/>	GWF1510MA840	✓
Power LED dimmable DALI - 220-240 V 50/60 Hz										
25	II	✓	-	90	4000	-	2400	<input type="checkbox"/>	GWF1511MA940	✓
25	II	✓	-	80	4000	-	2600	<input type="checkbox"/>	GWF1511MA840	✓



ELIA DL L2 35W OPAL

IP40 - IK06 - 650 °C

LUMINAIRE WATTAGE [W]	CLASS	ENEC	DIR EN 12464-1	CRI	KELVIN	LIGHTSOURCE LUMEN OUTPUT [lm]	LUMINAIRE LUMEN OUTPUT [lm]	COLOUR / FINISH	PART NUMBER	UKCA
Power LED 220-240 V 50/60 Hz										
35	II	✓	-	90	4000	-	3300	<input type="checkbox"/>	GWF1510QA940	✓
35	II	✓	-	80	4000	-	3600	<input type="checkbox"/>	GWF1510QA840	✓
Power LED dimmable DALI - 220-240 V 50/60 Hz										
35	II	✓	-	90	4000	-	3300	<input type="checkbox"/>	GWF1511QA940	✓
35	II	✓	-	80	4000	-	3600	<input type="checkbox"/>	GWF1511QA840	✓



Optional accessories

DESCRIPTION	COLOR	PART NUMBER	UKCA
ELIA DL			
Emergency kit 3h		GWS2992	✓



GWS2992

Office



Finstral Customer Center - Gochsheimt - Germany

Today's workspaces require new design directions. Putting people at the heart of the project, we study lighting systems and solutions to create efficient, comfortable, and functional work areas. Waiting rooms, meeting rooms, work and circulation spaces: the lighting in offices should promote dynamism and concentration and provide highly efficient solutions essential for stimulating creativity and improving the team's performance.



Office

ELIA PL M1 1200

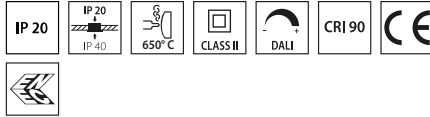

Scan the QR-code for the latest information

WH-RAL9016 / White RAL9016 /

LED lowbay for lighting offices

- Available in square or rectangular versions with a frame in white powder-coated die-cast aluminium and two types of PMMA shield, a high-efficiency micro-prism version with a UGR of less than 19 and an opal version with an UGR of 22
- The family of products is available with a colour temperature of 3,000K (warm white) or 4,000K (neutral white), a colour rendering index of more than 80 or more than 90 and a separate electronic power supply supplied as part of a kit, in On/Off or DALI versions
- ELIA PL is easy to install thanks to the reduced weight of the device and the connector for electrical wiring which enables connection to the remote power supply
- ELIA PL can be flush-mounted in false ceilings with standard panels, or alternatively, can be ceiling or suspension-mounted using the accessories provided separately
- External emergency kit with 3h autonomy available (to be ordered separately)

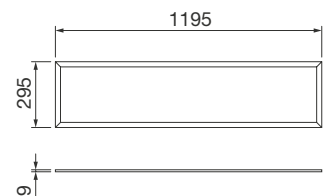

ELIA PL M1 1200

ELIA PL M1 1200 MP

IP20 - IK03 - 650 °C

LUMINAIRE WATTAGE (W)	CLASS	ENEC	DIN EN 12464-1	CRI	KELVIN	LIGHTSOURCE LUMEN OUTPUT (lm)	LUMINAIRE LUMEN OUTPUT (lm)	COLOUR / FINISH	LENGTH (mm)	PART NUMBER	UKCA
Power LED 220-240 V 50/60 Hz											
33	II	✓	-	90	4000	-	3600	□	1195	GWF1610LN940	✓
33	II	✓	-	90	3000	-	3300	□	1195	GWF1610LN930	✓
33	II	✓	-	80	4000	-	4300	□	1195	GWF1610LN840	✓
33	II	✓	-	80	3000	-	4000	□	1195	GWF1610LN830	✓
Power LED dimmable DALI - 220-240 V 50/60 Hz											
33	II	✓	-	90	4000	-	3600	□	1195	GWF1611LN940	✓
33	II	✓	-	90	3000	-	3300	□	1195	GWF1611LN930	✓
33	II	✓	-	80	4000	-	4300	□	1195	GWF1611LN840	✓
33	II	✓	-	80	3000	-	4000	□	1195	GWF1611LN830	✓

ELIA PL M1 1200 OP

IP20 - IK03 - 650 °C

LUMINAIRE WATTAGE (W)	CLASS	ENEC	DIN EN 12464-1	CRI	KELVIN	LIGHTSOURCE LUMEN OUTPUT (lm)	LUMINAIRE LUMEN OUTPUT (lm)	COLOUR / FINISH	LENGTH (mm)	PART NUMBER	UKCA
Power LED 220-240 V 50/60 Hz											
33	II	✓	-	90	4000	-	3600	□	1195	GWF1610LA940	✓
33	II	✓	-	90	3000	-	3300	□	1195	GWF1610LA930	✓
33	II	✓	-	80	4000	-	4300	□	1195	GWF1610LA840	✓
33	II	✓	-	80	3000	-	4000	□	1195	GWF1610LA830	✓
Power LED dimmable DALI - 220-240 V 50/60 Hz											
33	II	✓	-	90	4000	-	3600	□	1195	GWF1611LA940	✓
33	II	✓	-	90	3000	-	3300	□	1195	GWF1611LA930	✓
33	II	✓	-	80	4000	-	4300	□	1195	GWF1611LA840	✓
33	II	✓	-	80	3000	-	4000	□	1195	GWF1611LA830	✓

Optional accessories

DESCRIPTION	COLOR	PART NUMBER	UKCA
ELIA PL M1 1200			
Suspension kit with 4 cables		GWF1921	✓
Safety cable kit		GWF1923	✓
Kit with 4 springs for flush-mounting		GWF1922	✓
Ceiling box kit 300x1200 mm - white		GWF1913	✓
Assemblable ceiling box kit 300x1200 mm - white		GWF1919	✓
Emergency kit 3h		GWS2992	✓



GWF1921



GWS2992

ELIA PL M2 600

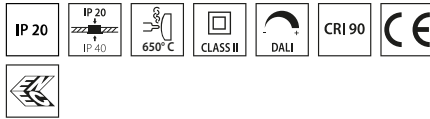
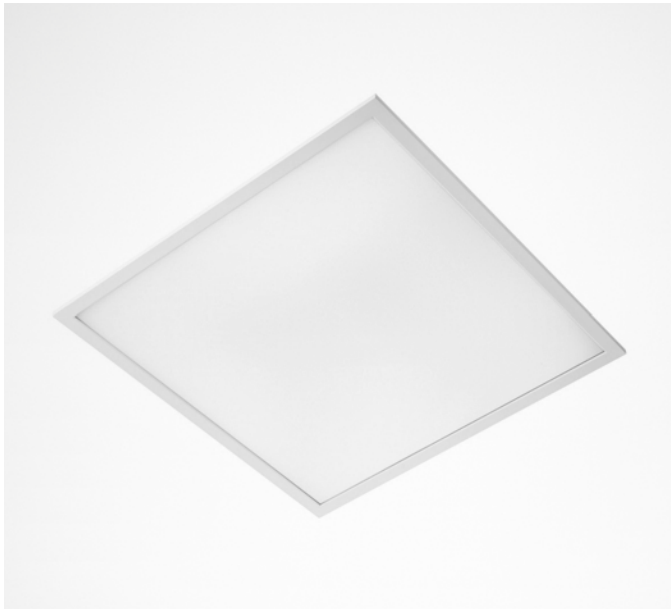

Scan the QR-code for the latest information

□ WH-RAL9016 / White RAL9016 /

LED lowbay for lighting offices

- Available in square or rectangular versions with a frame in white powder-coated die-cast aluminium and two types of PMMA shield, a high-efficiency micro-prism version with a UGR of less than 19 and an opal version with an UGR of 22
- The family of products is available with a colour temperature of 3,000K (warm white) or 4,000K (neutral white), a colour rendering index of more than 80 or more than 90 and a separate electronic power supply supplied as part of a kit, in On/Off or DALI versions
- ELIA PL is easy to install thanks to the reduced weight of the device and the connector for electrical wiring which enables connection to the remote power supply
- ELIA PL can be flush-mounted in false ceilings with standard panels, or alternatively, can be ceiling or suspension-mounted using the accessories provided separately
- External emergency kit with 3h autonomy available (to be ordered separately)



Campus Della Salute - Pavia - Italy

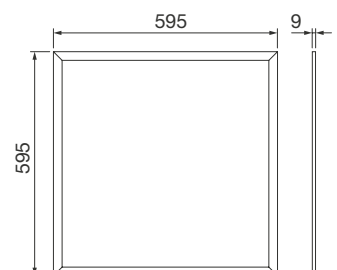

ELIA PL M2 600

ELIA PL M2 600 MP

IP20 - IK03 - 650 °C

LUMINAIRE WATTAGE (W)	CLASS	ENEC	DIN EN 12464-1	CRI	KELVIN	LIGHTSOURCE LUMEN OUTPUT (lm)	LUMINAIRE LUMEN OUTPUT (lm)	COLOUR / FINISH	LENGTH (mm)	PART NUMBER	UKCA
Power LED 220-240 V 50/60 Hz											
33	II	✓	-	90	4000	-	3600	□	595	GWF1610MN940	✓
33	II	✓	-	90	3000	-	3300	□	595	GWF1610MN930	✓
33	II	✓	-	80	4000	-	4300	□	595	GWF1610MN840	✓
33	II	✓	-	80	3000	-	4000	□	595	GWF1610MN830	✓
Power LED dimmable DALI - 220-240 V 50/60 Hz											
33	II	✓	-	90	4000	-	3600	□	595	GWF1611MN940	✓
33	II	✓	-	90	3000	-	3300	□	595	GWF1611MN930	✓
33	II	✓	-	80	4000	-	4300	□	595	GWF1611MN840	✓
33	II	✓	-	80	3000	-	4000	□	595	GWF1611MN830	✓



ELIA PL M2 600 OP

IP20 - IK03 - 650 °C

LUMINAIRE WATTAGE (W)	CLASS	ENEC	DIN EN 12464-1	CRI	KELVIN	LIGHTSOURCE LUMEN OUTPUT (lm)	LUMINAIRE LUMEN OUTPUT (lm)	COLOUR / FINISH	LENGTH (mm)	PART NUMBER	UKCA
Power LED 220-240 V 50/60 Hz											
33	II	✓	-	90	4000	-	3600	□	595	GWF1610MA940	✓
33	II	✓	-	90	3000	-	3300	□	595	GWF1610MA930	✓
33	II	✓	-	80	4000	-	4300	□	595	GWF1610MA840	✓
33	II	✓	-	80	3000	-	4000	□	595	GWF1610MA830	✓
Power LED dimmable DALI - 220-240 V 50/60 Hz											
33	II	✓	-	90	4000	-	3600	□	595	GWF1611MA940	✓
33	II	✓	-	90	3000	-	3300	□	595	GWF1611MA930	✓
33	II	✓	-	80	4000	-	4300	□	595	GWF1611MA840	✓
33	II	✓	-	80	3000	-	4000	□	595	GWF1611MA830	✓



Office

Optional accessories

DESCRIPTION	COLOR	PART NUMBER	UKCA
ELIA PL M2 600			
Suspension kit with 4 cables		GWF1921	✓
Safety cable kit		GWF1923	✓
Kit with 4 springs for flush-mounting		GWF1922	✓
Ceiling box kit 600x600 mm - white		GWF1911	✓
Assemblable ceiling box kit 600x600 mm - white		GWF1917	✓
Emergency kit 3h		GWS2992	✓



GWF1921



GWS2992

ELIA PL M3 625

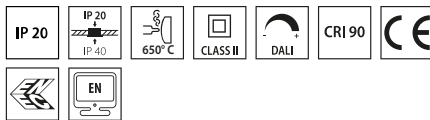

Scan the QR-code for the latest information

□ WH-RAL9016 / White RAL9016 /

LED lowbay for lighting offices

- Available in square or rectangular versions with a frame in white powder-coated die-cast aluminium and two types of PMMA shield, a high-efficiency micro-prism version with a UGR of less than 19 and an opal version with an UGR of 22
- The family of products is available with a colour temperature of 3,000K (warm white) or 4,000K (neutral white), a colour rendering index of more than 80 or more than 90 and a separate electronic power supply supplied as part of a kit, in On/Off or DALI versions
- ELIA PL is easy to install thanks to the reduced weight of the device and the connector for electrical wiring which enables connection to the remote power supply
- ELIA PL can be flush-mounted in false ceilings with standard panels, or alternatively, can be ceiling or suspension-mounted using the accessories provided separately
- External emergency kit with 3h autonomy available (to be ordered separately)



Albinoleffe stadium - Zanica - Italy

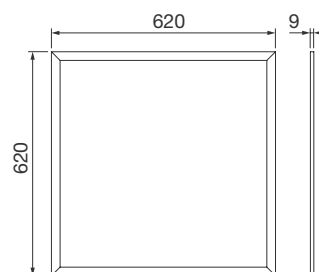

ELIA PL M3 625

ELIA PL M3 625 MP

IP20 - IK03 - 650 °C

LUMINAIRE WATTAGE (W)	CLASS	ENEC	DIN EN 12464-1	CRI	KELVIN	LIGHTSOURCE LUMEN OUTPUT (lm)	LUMINAIRE LUMEN OUTPUT (lm)	COLOUR / FINISH	LENGTH (mm)	PART NUMBER	UKCA
Power LED 220-240 V 50/60 Hz											
33	II	✓	-	90	4000	-	3600	□	620	GWF1610NN940	✓
33	II	✓	-	90	3000	-	3300	□	620	GWF1610NN930	✓
33	II	✓	-	80	4000	-	4300	□	620	GWF1610NN840	✓
33	II	✓	-	80	3000	-	4000	□	620	GWF1610NN830	✓
Power LED dimmable DALI - 220-240 V 50/60 Hz											
33	II	✓	-	90	4000	-	3600	□	620	GWF1611NN940	✓
33	II	✓	-	90	3000	-	3300	□	620	GWF1611NN930	✓
33	II	✓	-	80	4000	-	4300	□	620	GWF1611NN840	✓
33	II	✓	-	80	3000	-	4000	□	620	GWF1611NN830	✓



ELIA PL M3 625 OP

IP20 - IK03 - 650 °C

LUMINAIRE WATTAGE (W)	CLASS	ENEC	DIN EN 12464-1	CRI	KELVIN	LIGHTSOURCE LUMEN OUTPUT (lm)	LUMINAIRE LUMEN OUTPUT (lm)	COLOUR / FINISH	LENGTH (mm)	PART NUMBER	UKCA
Power LED 220-240 V 50/60 Hz											
33	II	✓	-	90	4000	-	3600	□	620	GWF1610NA940	✓
33	II	✓	-	90	3000	-	3300	□	620	GWF1610NA930	✓
33	II	✓	-	80	4000	-	4300	□	620	GWF1610NA840	✓
33	II	✓	-	80	3000	-	4000	□	620	GWF1610NA830	✓
Power LED dimmable DALI - 220-240 V 50/60 Hz											
33	II	✓	-	90	4000	-	3600	□	620	GWF1611NA940	✓
33	II	✓	-	90	3000	-	3300	□	620	GWF1611NA930	✓
33	II	✓	-	80	4000	-	4300	□	620	GWF1611NA840	✓
33	II	✓	-	80	3000	-	4000	□	620	GWF1611NA830	✓



Office

Optional accessories

DESCRIPTION	COLOR	PART NUMBER	UKCA
ELIA PL M3 625			
Suspension kit with 4 cables		GWF1921	✓
Safety cable kit		GWF1923	✓
Kit with 4 springs for flush-mounting		GWF1922	✓
Ceiling box kit 620x620 mm - white		GWF1912	✓
Assemblable ceiling box kit 620x620 mm - white		GWF1918	✓
Emergency kit 3h		GWS2992	✓



GWF1921



GWS2992

ELIA PL IP65 M1 1200

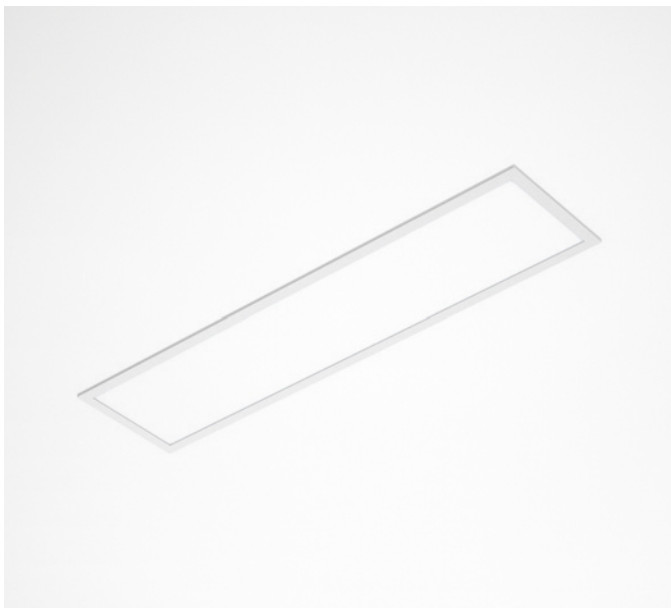

Scan the QR-code for the latest information

WH-RAL9016 / White RAL9016 /

- Modular recessed LED luminaire for indoor applications which require a high resistance against penetration of water and dust, such as high-humidity ambients
- Available in 3 different sizes (300 x 1200 mm, 600 x 600 mm and 620 x 620 mm), it is suitable for flush-mounting in modular ceilings and can alternatively be ceiling or suspension-mounted using dedicated accessories (to be ordered separately)
 - The range allows for great flexibility with its possible combinations of colour temperatures: it can be ordered in 3,000 K (warm white) or 4,000 K (neutral white), both with a colour rendering index (CRI) of 80
 - The luminaire is equipped with an opal diffuser with UGR lower than 22 and with an On/Off external power supply which is also IP65-rated (included with the product). Both sides of the luminaire are IP65 rated



GEWISS Stadium - Bergamo - Italy

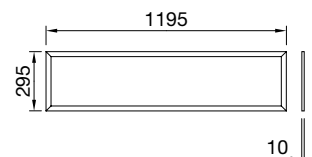

ELIA PL IP65 M1 1200

ELIA PL IP65 M1 1200 OP

IP65 - IK03 - 650 °C

LUMINAIRE WATTAGE (W)	CLASS	ENEC	DIN EN 12464-1	CRI	KELVIN	LIGHTSOURCE LUMEN OUTPUT (lm)	LUMINAIRE LUMEN OUTPUT (lm)	COLOUR / FINISH	LENGTH (mm)	PART NUMBER	UKCA
Power LED 200-240 V 50/60 Hz											
36	II	✓	-	80	4000	-	3600	□	1195	GWF1910LA840	✓
36	II	✓	-	80	3000	-	3300	□	1195	GWF1910LA830	✓



Office

Optional accessories

DESCRIPTION	COLOR	PART NUMBER	UKCA
ELIA PL IP65 M1 1200			
Suspension kit with 4 cables		GWF1924	✓
Assemblable ceiling box kit 300x1200 mm - white		GWF1919	✓
Safety cable kit		GWF1923	✓
Kit with 4 springs for flush-mounting		GWF1925	✓
Ceiling box kit 300x1200 mm - white		GWF1932	✓



GWF1921

ELIA PL IP65 M2 600

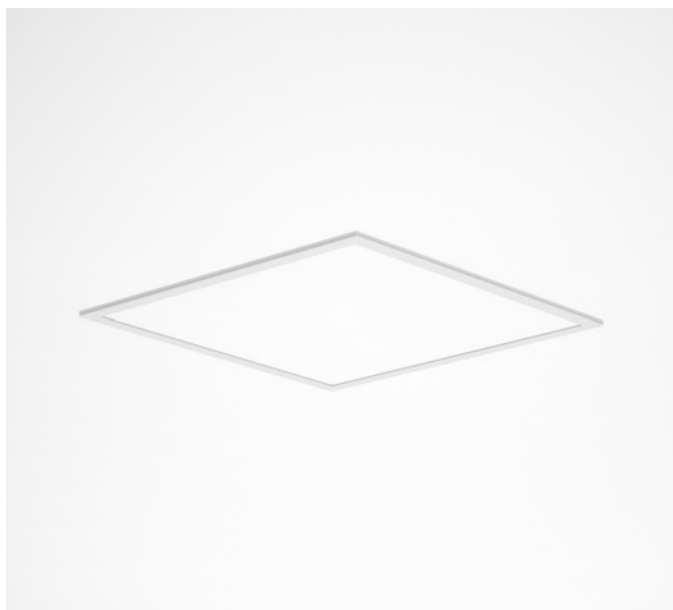

Scan the QR-code for the latest information

□ WH-RAL9016 / White RAL9016 /

- Modular recessed LED luminaire for indoor applications which require a high resistance against penetration of water and dust, such as high-humidity ambients
- Available in 3 different sizes (300 x 1200 mm, 600 x 600 mm and 620 x 620 mm), it is suitable for flush-mounting in modular ceilings and can alternatively be ceiling or suspension-mounted using dedicated accessories (to be ordered separately)
 - The range allows for great flexibility with its possible combinations of colour temperatures: it can be ordered in 3,000 K (warm white) or 4,000 K (neutral white), both with a colour rendering index (CRI) of 80
 - The luminaire is equipped with an opal diffuser with UGR lower than 22 and with an On/Off external power supply which is also IP65-rated (included with the product). Both sides of the luminaire are IP65 rated



Campus Della Salute - Pavia - Italy

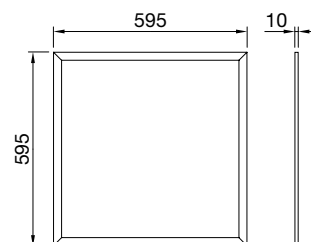

ELIA PL IP65 M2 600

ELIA PL IP65 M2 600 OP

IP65 - IK03 - 650 °C



LUMINAIRE WATTAGE (W)	CLASS	ENEC	DIN EN 12464-1	CRI	KELVIN	LIGHTSOURCE LUMEN OUTPUT (lm)	LUMINAIRE LUMEN OUTPUT (lm)	COLOUR / FINISH	LENGTH (mm)	PART NUMBER	UKCA
Power LED 200-240 V 50/60 Hz											
36	II	✓	-	80	4000	-	3600	□	595	GWF1910MA840	✓
36	II	✓	-	80	3000	-	3300	□	595	GWF1910MA830	✓

Office

Optional accessories

DESCRIPTION	COLOR	PART NUMBER	UKCA
ELIA PL IP65 M2 600			
Assemblable ceiling box kit 600x600 mm - white		GWF1917	✓
Ceiling box kit 600x600 mm - white		GWF1930	✓
Suspension kit with 4 cables		GWF1924	✓
Safety cable kit		GWF1923	✓
Kit with 4 springs for flush-mounting		GWF1925	✓



GWF1921

ELIA PL IP65 M3 625

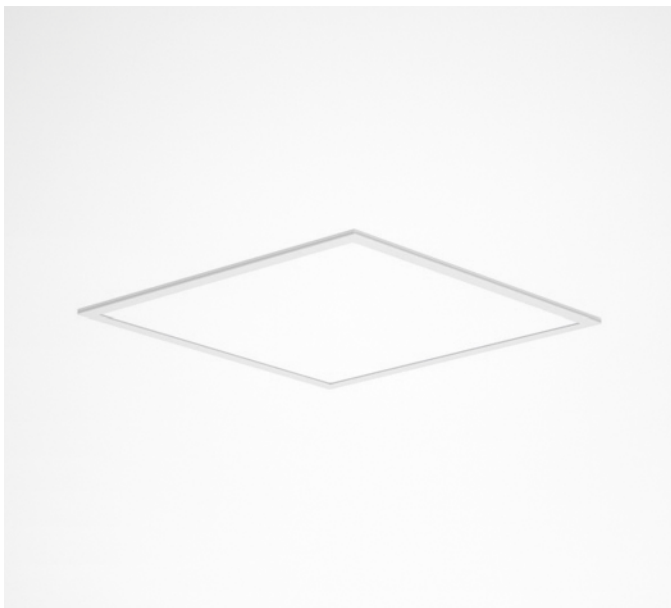

Scan the QR-code for the latest information

□ WH-RAL9016 / White RAL9016 /

- Modular recessed LED luminaire for indoor applications which require a high resistance against penetration of water and dust, such as high-humidity ambients
- Available in 3 different sizes (300 x 1200 mm, 600 x 600 mm and 620 x 620 mm), it is suitable for flush-mounting in modular ceilings and can alternatively be ceiling or suspension-mounted using dedicated accessories (to be ordered separately)
 - The range allows for great flexibility with its possible combinations of colour temperatures: it can be ordered in 3,000 K (warm white) or 4,000 K (neutral white), both with a colour rendering index (CRI) of 80
 - The luminaire is equipped with an opal diffuser with UGR lower than 22 and with an On/Off external power supply which is also IP65-rated (included with the product). Both sides of the luminaire are IP65 rated



Campus Della Salute - Pavia - Italy

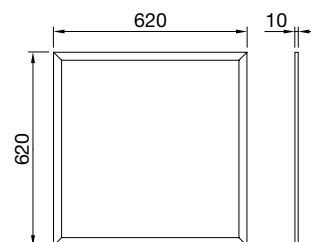

ELIA PL IP65 M3 625

ELIA PL IP65 M3 625 OP

IP65 - IK03 - 650 °C

LUMINAIRE WATTAGE (W)	CLASS	ENEC	DIN EN 12464-1	CRI	KELVIN	LIGHTSOURCE LUMEN OUTPUT (lm)	LUMINAIRE LUMEN OUTPUT (lm)	COLOUR / FINISH	LENGTH (mm)	PART NUMBER	UKCA
Power LED 200-240 V 50/60 Hz											
36	II	✓	-	80	4000	-	3600	□	620	GWF1910NA840	✓
36	II	✓	-	80	3000	-	3300	□	620	GWF1910NA830	✓



Office

Optional accessories

DESCRIPTION	COLOR	PART NUMBER	UKCA
ELIA PL IP65 M3 625			
Suspension kit with 4 cables		GWF1924	✓
Safety cable kit		GWF1923	✓
Kit with 4 springs for flush-mounting		GWF1925	✓
Assemblable ceiling box kit 620x620 mm - white		GWF1918	✓
Ceiling box kit 620x620 mm - white		GWF1931	✓



GWF1921

ELIA PL BACKLIT M1 1200

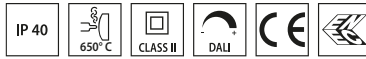

Scan the QR-code for the latest information

□ WH-RAL9016 / White RAL9016 /

Modular recessed LED luminaire for indoor lighting applications

- Thanks to its superior energy efficiency, it is the ideal solution for a fast return on investment in the replacement of traditional lighting systems
- Available in 3 different sizes (300 x 1200 mm, 600 x 600 mm and 620 x 620 mm), it is suitable for flush-mounting in modular ceilings and can alternatively be ceiling or suspension-mounted using dedicated accessories (to be ordered separately)
- The range allows for great flexibility with its multiple possible combinations of colour temperatures and control systems: it can be ordered in 3,000 K (warm white) or 4,000 K (neutral white), both with a colour rendering index (CRI) of 80; and with an On/Off or DALI external power supply (included with the product)
- The luminaire is equipped with an opal diffuser with UGR lower than 22
- It is easy to install thanks to its reduced weight and its quick coupling connector for fast electrical wiring
- External emergency kit with 3h autonomy available (to be ordered separately)



Campus Della Salute - Pavia - Italy

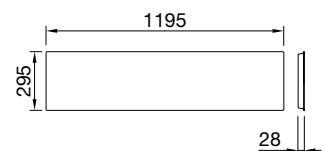

ELIA PL BACKLIT M1 1200

ELIA PL BACKLIT M1 1200 OP

IP40 - IK03 - 650 °C

LUMINAIRE WATTAGE (W)	CLASS	ENEC	DIN EN 12464-1	CRI	KELVIN	LIGHTSOURCE LUMEN OUTPUT (lm)	LUMINAIRE LUMEN OUTPUT (lm)	COLOUR / FINISH	LENGTH (mm)	PART NUMBER	UKCA
Power LED 220-240 V 50/60 Hz											
25	II	✓	-	80	4000	-	3300	□	1195	GWF1610LT840	✓
25	II	✓	-	80	3000	-	3000	□	1195	GWF1610LT830	✓
Power LED dimmable DALI - 220-240 V 50/60 Hz											
25	II	✓	-	80	4000	-	3300	□	1195	GWF1611LT840	✓
25	II	✓	-	80	3000	-	3000	□	1195	GWF1611LT830	✓



Office

Optional accessories

DESCRIPTION	COLOR	PART NUMBER	UKCA
ELIA PL BACKLIT M1 1200			
Suspension kit with 4 cables		GWF1926	✓
Assemblable ceiling box kit 300x1200 mm - white		GWF1919	✓
Emergency kit 3h		GWS2992	✓



GWS2992

ELIA PL BACKLIT M2 600



Scan the QR-code for the latest information

□ WH-RAL9016 / White RAL9016 /

Modular recessed LED luminaire for indoor lighting applications

- Thanks to its superior energy efficiency, it is the ideal solution for a fast return on investment in the replacement of traditional lighting systems
- Available in 3 different sizes (300 x 1200 mm, 600 x 600 mm and 620 x 620 mm), it is suitable for flush-mounting in modular ceilings and can alternatively be ceiling or suspension-mounted using dedicated accessories (to be ordered separately)
- The range allows for great flexibility with its multiple possible combinations of colour temperatures and control systems: it can be ordered in 3,000 K (warm white) or 4,000 K (neutral white), both with a colour rendering index (CRI) of 80; and with an On/Off or DALI external power supply (included with the product)
- The luminaire is equipped with an opal diffuser with UGR lower than 22
- It is easy to install thanks to its reduced weight and its quick coupling connector for fast electrical wiring
- External emergency kit with 3h autonomy available (to be ordered separately)



Orobia Climbing - Curno - Italy

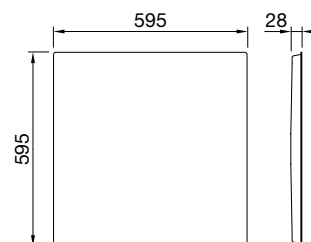

ELIA PL BACKLIT M2 600

ELIA PL BACKLIT M2 600 OP

IP40 - IK03 - 650 °C



LUMINAIRE WATTAGE (W)	CLASS	ENEC	DIN EN 12464-1	CRI	KELVIN	LIGHTSOURCE LUMEN OUTPUT (lm)	LUMINAIRE LUMEN OUTPUT (lm)	COLOUR / FINISH	LENGTH (mm)	PART NUMBER	UKCA
Power LED 220-240 V 50/60 Hz											
25	II	✓	-	80	4000	-	3300	□	595	GWF1610MT840	✓
25	II	✓	-	80	3000	-	3000	□	595	GWF1610MT830	✓
Power LED dimmable DALI - 220-240 V 50/60 Hz											
25	II	✓	-	80	4000	-	3300	□	595	GWF1611MT840	✓
25	II	✓	-	80	3000	-	3000	□	595	GWF1611MT830	✓

Office

Optional accessories

DESCRIPTION	COLOR	PART NUMBER	UKCA
ELIA PL BACKLIT M2 600			
Suspension kit with 4 cables		GWF1926	✓
Assemblable ceiling box kit 600x600 mm - white		GWF1917	✓
Emergency kit 3h		GWS2992	✓



GWS2992

ELIA PL BACKLIT M3 625



Scan the QR-code for the latest information

□ WH-RAL9016 / White RAL9016 /

Modular recessed LED luminaire for indoor lighting applications

- Thanks to its superior energy efficiency, it is the ideal solution for a fast return on investment in the replacement of traditional lighting systems
- Available in 3 different sizes (300 x 1200 mm, 600 x 600 mm and 620 x 620 mm), it is suitable for flush-mounting in modular ceilings and can alternatively be ceiling or suspension-mounted using dedicated accessories (to be ordered separately)
- The range allows for great flexibility with its multiple possible combinations of colour temperatures and control systems: it can be ordered in 3,000 K (warm white) or 4,000 K (neutral white), both with a colour rendering index (CRI) of 80; and with an On/Off or DALI external power supply (included with the product)
- The luminaire is equipped with an opal diffuser with UGR lower than 22
- It is easy to install thanks to its reduced weight and its quick coupling connector for fast electrical wiring
- External emergency kit with 3h autonomy available (to be ordered separately)



Campus Della Salute - Pavia - Italy

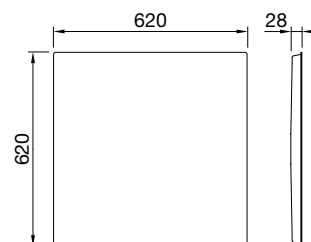

ELIA PL BACKLIT M3 625

ELIA PL BACKLIT M3 625 OP

IP40 - IK03 - 650 °C

LUMINAIRE WATTAGE (W)	CLASS	ENEC	DIN EN 12464-1	CRI	KELVIN	LIGHTSOURCE LUMEN OUTPUT (lm)	LUMINAIRE LUMEN OUTPUT (lm)	COLOUR / FINISH	LENGTH (mm)	PART NUMBER	UKCA
Power LED 220-240 V 50/60 Hz											
25	II	✓	-	80	4000	-	3300	□	620	GWF1610NT840	✓
25	II	✓	-	80	3000	-	3000	□	620	GWF1610NT830	✓
Power LED dimmable DALI - 220-240 V 50/60 Hz											
25	II	✓	-	80	4000	-	3300	□	620	GWF1611NT840	✓
25	II	✓	-	80	3000	-	3000	□	620	GWF1611NT830	✓



Office

Optional accessories

DESCRIPTION	COLOR	PART NUMBER	UKCA
ELIA PL BACKLIT M3 625			
Suspension kit with 4 cables		GWF1926	✓
Assemblable ceiling box kit 620x620 mm - white		GWF1918	✓
Emergency kit 3h		GWS2992	✓



GWS2992

VISIO [16] M1 1200



WH-RAL9016 / White RAL9016 /

Scan the QR-code for the latest information

Modular recessed LED luminaire ideal for work and study environments. It was designed to ensure maximum visual comfort, thanks to an advanced low-glare optical system (UGR < 16) and a high colour rendering LED source

- Available in 3 different sizes (300 x 1200 mm, 600 x 600 mm and 620 x 620 mm), it is suitable for flush-mounting in modular ceilings and can alternatively be ceiling or suspension-mounted using dedicated accessories (to be ordered separately)
- The range allows for great flexibility with its multiple possible combinations of colour temperatures and control systems: it can be ordered in 3,000 K (warm white) or 4,000 K (neutral white), both with a colour rendering index (CRI) above 90 for a crisp light; and with an On/Off or DALI external power supply (included with the product)
- The luminaire is easy to install thanks to its quick coupling connector for fast electrical wiring
- External emergency kit with 3h autonomy available (to be ordered separately)

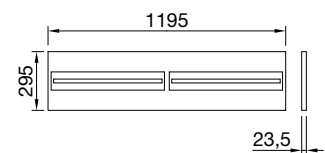

VISIO [16] M1 1200

VISIO [16] M1 1200

IP40 - IK06 - 850 °C



LUMINAIRE WATTAGE (W)	CLASS	ENEC	DIN EN 12464-1	CRI	KELVIN	LIGHTSOURCE LUMEN OUTPUT (lm)	LUMINAIRE LUMEN OUTPUT (lm)	COLOUR / FINISH	LENGTH (mm)	PART NUMBER	UKCA
Power LED 220-240 V 50/60 Hz											
35	II	✓	-	90	4000	-	3300	□	1195	GWF1810LL940	✓
35	II	✓	-	90	3000	-	3000	□	1195	GWF1810LL930	✓
Power LED dimmable DALI - 220-240 V 50/60 Hz											
35	II	✓	-	90	4000	-	3300	□	1195	GWF1811LL940	✓
35	II	✓	-	90	3000	-	3000	□	1195	GWF1811LL930	✓

Office

Optional accessories

DESCRIPTION	COLOR	PART NUMBER	UKCA
VISIO [16] M1 1200			
Suspension kit with 4 cables		GWF1928	✓
Safety cable kit		GWF1923	✓
Kit with 4 springs for flush-mounting		GWF1929	✓
Ceiling box kit 300x1200 mm - white		GWF1932	✓
Emergency kit 3h		GWS2992	✓



GWF1921



GWS2992

VISIO [16] M2 600

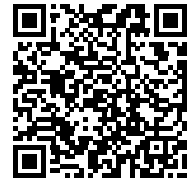

WH-RAL9016 / White RAL9016 /

Scan the QR-code for the latest information

Modular recessed LED luminaire ideal for work and study environments. It was designed to ensure maximum visual comfort, thanks to an advanced low-glare optical system (UGR < 16) and a high colour rendering LED source

- Available in 3 different sizes (300 x 1200 mm, 600 x 600 mm and 620 x 620 mm), it is suitable for flush-mounting in modular ceilings and can alternatively be ceiling or suspension-mounted using dedicated accessories (to be ordered separately)
- The range allows for great flexibility with its multiple possible combinations of colour temperatures and control systems: it can be ordered in 3,000 K (warm white) or 4,000 K (neutral white), both with a colour rendering index (CRI) above 90 for a crisp light; and with an On/Off or DALI external power supply (included with the product)
- The luminaire is easy to install thanks to its quick coupling connector for fast electrical wiring
- External emergency kit with 3h autonomy available (to be ordered separately)

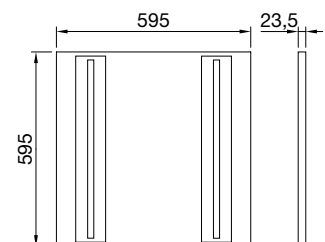

VISIO [16] M2 600

VISIO [16] M2 600

IP40 - IK06 - 850 °C

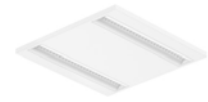

LUMINAIRE WATTAGE (W)	CLASS	ENEC	DIN EN 12464-1	CRI	KELVIN	LIGHTSOURCE LUMEN OUTPUT (lm)	LUMINAIRE LUMEN OUTPUT (lm)	COLOUR / FINISH	LENGTH (mm)	PART NUMBER	UKCA
Power LED 220-240 V 50/60 Hz											
35	II	✓	-	90	4000	-	3300	□	595	GWF1810ML940	✓
35	II	✓	-	90	3000	-	3000	□	595	GWF1810ML930	✓
Power LED dimmable DALI - 220-240 V 50/60 Hz											
35	II	✓	-	90	4000	-	3300	□	595	GWF1811ML940	✓
35	II	✓	-	90	3000	-	3000	□	595	GWF1811ML930	✓

Office

Optional accessories

DESCRIPTION	COLOR	PART NUMBER	UKCA
VISIO [16] M2 600			
Suspension kit with 4 cables		GWF1928	✓
Safety cable kit		GWF1923	✓
Kit with 4 springs for flush-mounting		GWF1929	✓
Ceiling box kit 600x600 mm - white		GWF1930	✓
Emergency kit 3h		GWS2992	✓



GWF1921



GWS2992

VISIO [16] M3 625

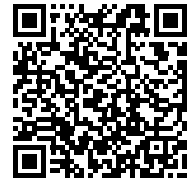

Scan the QR-code for the latest information

□ WH-RAL9016 / White RAL9016 /

Modular recessed LED luminaire ideal for work and study environments. It was designed to ensure maximum visual comfort, thanks to an advanced low-glare optical system (UGR < 16) and a high colour rendering LED source

- Available in 3 different sizes (300 x 1200 mm, 600 x 600 mm and 620 x 620 mm), it is suitable for flush-mounting in modular ceilings and can alternatively be ceiling or suspension-mounted using dedicated accessories (to be ordered separately)
- The range allows for great flexibility with its multiple possible combinations of colour temperatures and control systems: it can be ordered in 3,000 K (warm white) or 4,000 K (neutral white), both with a colour rendering index (CRI) above 90 for a crisp light; and with an On/Off or DALI external power supply (included with the product)
- The luminaire is easy to install thanks to its quick coupling connector for fast electrical wiring
- External emergency kit with 3h autonomy available (to be ordered separately)

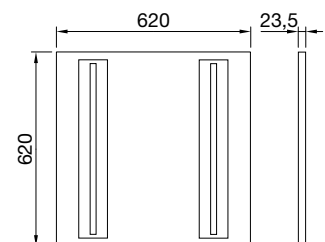

VISIO [16] M3 625

VISIO [16] M3 625

IP40 - IK06 - 850 °C

LUMINAIRE WATTAGE (W)	CLASS	ENEC	DIN EN 12464-1	CRI	KELVIN	LIGHTSOURCE LUMEN OUTPUT (lm)	LUMINAIRE LUMEN OUTPUT (lm)	COLOUR / FINISH	LENGTH (mm)	PART NUMBER	UKCA
Power LED 220-240 V 50/60 Hz											
35	II	✓	-	90	4000	-	3300	□	620	GWF1810NL940	✓
35	II	✓	-	90	3000	-	3000	□	620	GWF1810NL930	✓
Power LED dimmable DALI - 220-240 V 50/60 Hz											
35	II	✓	-	90	4000	-	3300	□	620	GWF1811NL940	✓
35	II	✓	-	90	3000	-	3000	□	620	GWF1811NL930	✓



Office

Optional accessories

DESCRIPTION	COLOR	PART NUMBER	UKCA
VISIO [16] M3 625			
Suspension kit with 4 cables		GWF1928	✓
Safety cable kit		GWF1923	✓
Kit with 4 springs for flush-mounting		GWF1929	✓
Ceiling box kit 620x620 mm - white		GWF1931	✓
Emergency kit 3h		GWS2992	✓



GWF1921



GWS2992

Industrial



ABI Offices and Production Facilities - Haarlem - Netherlands

In the industrial sector, where the settings can be subject to harsh conditions, we think of energy-efficient, resistant, and durable lighting solutions. We pay the greatest attention to reducing energy consumption and maintenance costs, guaranteeing maximum safety standards in the workplace and maximum visual comfort for workers. In facilities with high design complexity, we provide flexible and easy to manage lighting systems that guarantee significant energy savings.



SMART [4] 1M

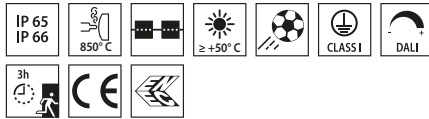

■ Grey RAL 7035 / Grey RAL7035 /

Scan the QR-code for the latest information

LED device suitable for the indoor lighting of industries and sports facilities

- Body in "Halogen-free" nylon loaded with grey glass fibre (RAL7035) with vent and anti-condensation device, heat sink in aluminium alloy EN AB 44300
- Available in 3 sizes: 1M, 2M and 4M
- Available in 3 versions: HE (High Efficiency), HLO (High Lumen Output) and DALI with integrated emergency kit
- Available in 3000K, 4000K and 5700K with CRI ≥80
- Available with integrated On/Off or DALI driver
- The version with through wiring has pre-wired mechanical and electrical connection components
- It is equipped with a dual optical system that includes a metallic reflector with ARRAY optics and a metallic reflector with UV stabilized PMMA lenses, with high efficiency, which allow a wide variety of light distributions 30°, 60°, 90°, Asymmetric and Elliptical
- Suspension, wall and projection appliances can be installed
- Available in DALI version with integrated emergency kit with 3h autonomy

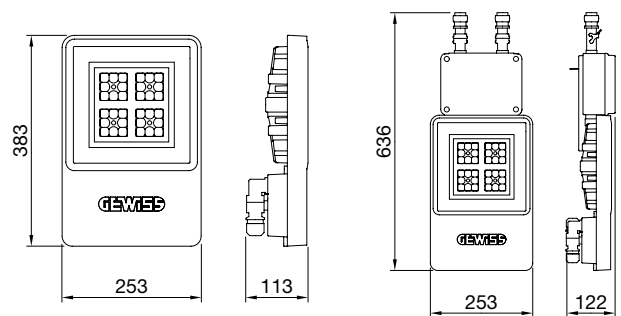

SMART [4] 1M

SMART [4] 1M
EM

Identifying and classifying our optics

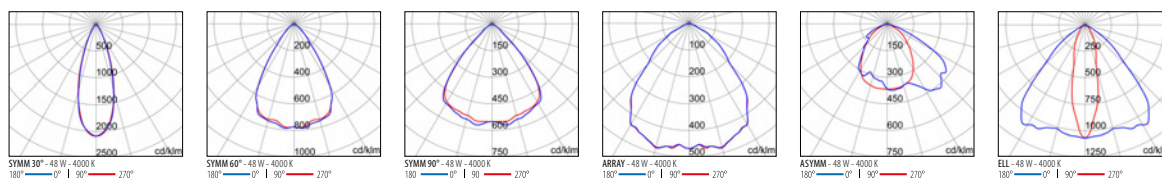

SMART [4] 1M HE

IP66 - IK08 - 850 °C



LUMINAIRE WATTAGE (W)	CLASS	ENEC	CRI	KELVIN	OPTIC	BEAM ANGLE	LIGHTSOURCE LUMEN OUTPUT (lm)	LUMINAIRE LUMEN OUTPUT (lm)	COLOUR / FINISH	PART NUMBER	UKCA
Power LED 220-240 V 50/60 Hz											
48	I	✓	80	5700	ARRAY	-	-	7700	■	GWS4120AA857	✓
48	I	✓	80	5700	ASYMM	-	-	6900	■	GWS4120AC857	✓
48	I	✓	80	5700	SYMM	30°	-	7600	■	GWS4120AF857	✓
48	I	✓	80	5700	SYMM	60°	-	7700	■	GWS4120AH857	✓
48	I	✓	80	5700	SYMM	90°	-	7700	■	GWS4120AP857	✓
48	I	✓	80	5700	ELL	-	-	7100	■	GWS4120AQ857	✓
48	I	✓	80	4000	ARRAY	-	-	7700	■	GWS4120AA840	✓
48	I	✓	80	4000	ASYMM	-	-	6900	■	GWS4120AC840	✓
48	I	✓	80	4000	SYMM	30°	-	7600	■	GWS4120AF840	✓
48	I	✓	80	4000	SYMM	60°	-	7700	■	GWS4120AH840	✓
48	I	✓	80	4000	SYMM	90°	-	7700	■	GWS4120AP840	✓
48	I	✓	80	4000	ELL	-	-	7100	■	GWS4120AQ840	✓
48	I	✓	80	3000	ARRAY	-	-	7300	■	GWS4120AA830	✓
48	I	✓	80	3000	ASYMM	-	-	6500	■	GWS4120AC830	✓
48	I	✓	80	3000	SYMM	30°	-	7200	■	GWS4120AF830	✓
48	I	✓	80	3000	SYMM	60°	-	7300	■	GWS4120AH830	✓
48	I	✓	80	3000	SYMM	90°	-	7300	■	GWS4120AP830	✓
48	I	✓	80	3000	ELL	-	-	6800	■	GWS4120AQ830	✓

Power LED dimmable DALI - 220-240 V 50/60 Hz

48	I	✓	80	5700	ARRAY	-	-	7700	■	GWS4121AA857	✓
48	I	✓	80	5700	ASYMM	-	-	6900	■	GWS4121AC857	✓
48	I	✓	80	5700	SYMM	30°	-	7600	■	GWS4121AF857	✓
48	I	✓	80	5700	SYMM	60°	-	7700	■	GWS4121AH857	✓
48	I	✓	80	5700	SYMM	90°	-	7700	■	GWS4121AP857	✓
48	I	✓	80	5700	ELL	-	-	7100	■	GWS4121AQ857	✓
48	I	✓	80	4000	ARRAY	-	-	7700	■	GWS4121AA840	✓
48	I	✓	80	4000	ASYMM	-	-	6900	■	GWS4121AC840	✓
48	I	✓	80	4000	SYMM	30°	-	7600	■	GWS4121AF840	✓
48	I	✓	80	4000	SYMM	60°	-	7700	■	GWS4121AH840	✓
48	I	✓	80	4000	SYMM	90°	-	7700	■	GWS4121AP840	✓
48	I	✓	80	4000	ELL	-	-	7100	■	GWS4121AQ840	✓
48	I	✓	80	3000	ARRAY	-	-	7300	■	GWS4121AA830	✓
48	I	✓	80	3000	ASYMM	-	-	6500	■	GWS4121AC830	✓
48	I	✓	80	3000	SYMM	30°	-	7200	■	GWS4121AF830	✓
48	I	✓	80	3000	SYMM	60°	-	7300	■	GWS4121AH830	✓
48	I	✓	80	3000	SYMM	90°	-	7300	■	GWS4121AP830	✓
48	I	✓	80	3000	ELL	-	-	6800	■	GWS4121AQ830	✓

SMART [4] 1M HE EM

IP65 - IK08 - 850 °C



LUMINAIRE WATTAGE (W)	CLASS	ENEC	CRI	KELVIN	OPTIC	BEAM ANGLE	LIGHTSOURCE LUMEN OUTPUT (lm)	LUMINAIRE LUMEN OUTPUT (lm)	COLOUR / FINISH	PART NUMBER	UKCA
Power LED - dimmable DALI 220-240 V 50/60 Hz - emergency 3h											
48	I	-	80	5700	ARRAY	-	-	7700	■	GWS4124AA857	✓
48	I	-	80	5700	ASYMM	-	-	6900	■	GWS4124AC857	✓
48	I	-	80	5700	SYMM	30°	-	7600	■	GWS4124AF857	✓
48	I	-	80	5700	SYMM	60°	-	7700	■	GWS4124AH857	✓
48	I	-	80	5700	SYMM	90°	-	7700	■	GWS4124AP857	✓
48	I	-	80	5700	ELL	-	-	7100	■	GWS4124AQ857	✓
48	I	-	80	4000	ARRAY	-	-	7700	■	GWS4124AA840	✓
48	I	-	80	4000	ASYMM	-	-	6900	■	GWS4124AC840	✓
48	I	-	80	4000	SYMM	30°	-	7600	■	GWS4124AF840	✓
48	I	-	80	4000	SYMM	60°	-	7700	■	GWS4124AH840	✓
48	I	-	80	4000	SYMM	90°	-	7700	■	GWS4124AP840	✓
48	I	-	80	4000	ELL	-	-	7100	■	GWS4124AQ840	✓
48	I	-	80	3000	ARRAY	-	-	7300	■	GWS4124AA830	✓
48	I	-	80	3000	ASYMM	-	-	6500	■	GWS4124AC830	✓
48	I	-	80	3000	SYMM	30°	-	7200	■	GWS4124AF830	✓
48	I	-	80	3000	SYMM	60°	-	7300	■	GWS4124AH830	✓
48	I	-	80	3000	SYMM	90°	-	7300	■	GWS4124AP830	✓
48	I	-	80	3000	ELL	-	-	6800	■	GWS4124AQ830	✓

SMART [4] 1M HE TW

IP66 - IK08 - 850 °C



LUMINAIRE WATTAGE (W)	CLASS	ENEC	CRI	KELVIN	OPTIC	BEAM ANGLE	LIGHTSOURCE LUMEN OUTPUT (lm)	LUMINAIRE LUMEN OUTPUT (lm)	COLOUR / FINISH	PART NUMBER	UKCA
Power LED 220-240 V 50/60 Hz - through-wiring											
48	I	✓	80	5700	ARRAY	-	-	7700	■	GWS4122AA857	✓
48	I	✓	80	5700	ASYMM	-	-	6900	■	GWS4122AC857	✓
48	I	✓	80	5700	SYMM	30°	-	7600	■	GWS4122AF857	✓
48	I	✓	80	5700	SYMM	60°	-	7700	■	GWS4122AH857	✓
48	I	✓	80	5700	SYMM	90°	-	7700	■	GWS4122AP857	✓
48	I	✓	80	5700	ELL	-	-	7100	■	GWS4122AQ857	✓
48	I	✓	80	4000	ARRAY	-	-	7700	■	GWS4122AA840	✓
48	I	✓	80	4000	ASYMM	-	-	6900	■	GWS4122AC840	✓
48	I	✓	80	4000	SYMM	30°	-	7600	■	GWS4122AF840	✓
48	I	✓	80	4000	SYMM	60°	-	7700	■	GWS4122AH840	✓
48	I	✓	80	4000	SYMM	90°	-	7700	■	GWS4122AP840	✓
48	I	✓	80	4000	ELL	-	-	7100	■	GWS4122AQ840	✓
48	I	✓	80	3000	ARRAY	-	-	7300	■	GWS4122AA830	✓
48	I	✓	80	3000	ASYMM	-	-	6500	■	GWS4122AC830	✓
48	I	✓	80	3000	SYMM	30°	-	7200	■	GWS4122AF830	✓
48	I	✓	80	3000	SYMM	60°	-	7300	■	GWS4122AH830	✓
48	I	✓	80	3000	SYMM	90°	-	7300	■	GWS4122AP830	✓
48	I	✓	80	3000	ELL	-	-	6800	■	GWS4122AQ830	✓
Power LED dimmable DALI 220-240 V 50/60 Hz - through-wiring											
48	I	✓	80	5700	ARRAY	-	-	7700	■	GWS4123AA857	✓
48	I	✓	80	5700	ASYMM	-	-	6900	■	GWS4123AC857	✓
48	I	✓	80	5700	SYMM	30°	-	7600	■	GWS4123AF857	✓
48	I	✓	80	5700	SYMM	60°	-	7700	■	GWS4123AH857	✓
48	I	✓	80	5700	SYMM	90°	-	7700	■	GWS4123AP857	✓
48	I	✓	80	5700	ELL	-	-	7100	■	GWS4123AQ857	✓
48	I	✓	80	4000	ARRAY	-	-	7700	■	GWS4123AA840	✓
48	I	✓	80	4000	ASYMM	-	-	6900	■	GWS4123AC840	✓
48	I	✓	80	4000	SYMM	30°	-	7600	■	GWS4123AF840	✓
48	I	✓	80	4000	SYMM	60°	-	7700	■	GWS4123AH840	✓
48	I	✓	80	4000	SYMM	90°	-	7700	■	GWS4123AP840	✓
48	I	✓	80	4000	ELL	-	-	7100	■	GWS4123AQ840	✓
48	I	✓	80	3000	ARRAY	-	-	7300	■	GWS4123AA830	✓
48	I	✓	80	3000	ASYMM	-	-	6500	■	GWS4123AC830	✓
48	I	✓	80	3000	SYMM	30°	-	7200	■	GWS4123AF830	✓
48	I	✓	80	3000	SYMM	60°	-	7300	■	GWS4123AH830	✓
48	I	✓	80	3000	SYMM	90°	-	7300	■	GWS4123AP830	✓
48	I	✓	80	3000	ELL	-	-	6800	■	GWS4123AQ830	✓

SMART [4] 1M HLO

IP66 - IK08 - 850 °C



LUMINAIRE WATTAGE (W)	CLASS	ENEC	CRI	KELVIN	OPTIC	BEAM ANGLE	LIGHTSOURCE LUMEN OUTPUT (lm)	LUMINAIRE LUMEN OUTPUT (lm)	COLOUR / FINISH	PART NUMBER	UKCA
Power LED 220-240 V 50/60 Hz											
64	I	✓	80	5700	ARRAY	-	-	9900	■	GWS4120BA857	✓
64	I	✓	80	5700	ASYMM	-	-	8900	■	GWS4120BC857	✓
64	I	✓	80	5700	SYMM	30°	-	9800	■	GWS4120BF857	✓
64	I	✓	80	5700	SYMM	60°	-	9900	■	GWS4120BH857	✓
64	I	✓	80	5700	SYMM	90°	-	9900	■	GWS4120BP857	✓
64	I	✓	80	5700	ELL	-	-	9200	■	GWS4120BQ857	✓
64	I	✓	80	4000	ARRAY	-	-	9900	■	GWS4120BA840	✓
64	I	✓	80	4000	ASYMM	-	-	8900	■	GWS4120BC840	✓
64	I	✓	80	4000	SYMM	30°	-	9800	■	GWS4120BF840	✓
64	I	✓	80	4000	SYMM	60°	-	9900	■	GWS4120BH840	✓
64	I	✓	80	4000	SYMM	90°	-	9900	■	GWS4120BP840	✓
64	I	✓	80	4000	ELL	-	-	9200	■	GWS4120BQ840	✓
64	I	✓	80	3000	ARRAY	-	-	9500	■	GWS4120BA830	✓
64	I	✓	80	3000	ASYMM	-	-	8500	■	GWS4120BC830	✓
64	I	✓	80	3000	SYMM	30°	-	9400	■	GWS4120BF830	✓
64	I	✓	80	3000	SYMM	60°	-	9500	■	GWS4120BH830	✓
64	I	✓	80	3000	SYMM	90°	-	9500	■	GWS4120BP830	✓
64	I	✓	80	3000	ELL	-	-	8800	■	GWS4120BQ830	✓
Power LED dimmable DALI - 220-240 V 50/60 Hz											
64	I	✓	80	5700	ARRAY	-	-	9900	■	GWS4121BA857	✓
64	I	✓	80	5700	ASYMM	-	-	8900	■	GWS4121BC857	✓
64	I	✓	80	5700	SYMM	30°	-	9800	■	GWS4121BF857	✓
64	I	✓	80	5700	SYMM	60°	-	9900	■	GWS4121BH857	✓
64	I	✓	80	5700	SYMM	90°	-	9900	■	GWS4121BP857	✓
64	I	✓	80	5700	ELL	-	-	9200	■	GWS4121BQ857	✓
64	I	✓	80	4000	ARRAY	-	-	9900	■	GWS4121BA840	✓
64	I	✓	80	4000	ASYMM	-	-	8900	■	GWS4121BC840	✓
64	I	✓	80	4000	SYMM	30°	-	9800	■	GWS4121BF840	✓
64	I	✓	80	4000	SYMM	60°	-	9900	■	GWS4121BH840	✓
64	I	✓	80	4000	SYMM	90°	-	9900	■	GWS4121BP840	✓
64	I	✓	80	4000	ELL	-	-	9200	■	GWS4121BQ840	✓
64	I	✓	80	3000	ARRAY	-	-	9500	■	GWS4121BA830	✓
64	I	✓	80	3000	ASYMM	-	-	8500	■	GWS4121BC830	✓
64	I	✓	80	3000	SYMM	30°	-	9400	■	GWS4121BF830	✓
64	I	✓	80	3000	SYMM	60°	-	9500	■	GWS4121BH830	✓
64	I	✓	80	3000	SYMM	90°	-	9500	■	GWS4121BP830	✓
64	I	✓	80	3000	ELL	-	-	8800	■	GWS4121BQ830	✓

SMART [4] 1M HLO EM

IP65 - IK08 - 850 °C

LUMINAIRE WATTAGE [W]	CLASS	ENEC	CRI	KELVIN	OPTIC	BEAM ANGLE	LIGHTSOURCE LUMEN OUTPUT [lm]	LUMINAIRE LUMEN OUTPUT [lm]	COLOUR / FINISH	PART NUMBER	UKCA
Power LED - dimmable DALI 220-240 V 50/60 Hz - emergency 3h											
64	I	-	80	5700	ARRAY	-	-	9900	■	GWS4124BA857	✓
64	I	-	80	5700	ASYMM	-	-	8900	■	GWS4124BC857	✓
64	I	-	80	5700	SYMM	30°	-	9800	■	GWS4124BF857	✓
64	I	-	80	5700	SYMM	60°	-	9900	■	GWS4124BH857	✓
64	I	-	80	5700	SYMM	90°	-	9900	■	GWS4124BP857	✓
64	I	-	80	5700	ELL	-	-	9200	■	GWS4124BQ857	✓
64	I	-	80	4000	ARRAY	-	-	9900	■	GWS4124BA840	✓
64	I	-	80	4000	ASYMM	-	-	8900	■	GWS4124BC840	✓
64	I	-	80	4000	SYMM	30°	-	9800	■	GWS4124BF840	✓
64	I	-	80	4000	SYMM	60°	-	9900	■	GWS4124BH840	✓
64	I	-	80	4000	SYMM	90°	-	9900	■	GWS4124BP840	✓
64	I	-	80	4000	ELL	-	-	9200	■	GWS4124BQ840	✓
64	I	-	80	3000	ARRAY	-	-	9500	■	GWS4124BA830	✓
64	I	-	80	3000	ASYMM	-	-	8500	■	GWS4124BC830	✓
64	I	-	80	3000	SYMM	30°	-	9400	■	GWS4124BF830	✓
64	I	-	80	3000	SYMM	60°	-	9500	■	GWS4124BH830	✓
64	I	-	80	3000	SYMM	90°	-	9500	■	GWS4124BP830	✓
64	I	-	80	3000	ELL	-	-	8800	■	GWS4124BQ830	✓



SMART [4] 1M HLO TW

IP66 - IK08 - 850 °C

LUMINAIRE WATTAGE [W]	CLASS	ENEC	CRI	KELVIN	OPTIC	BEAM ANGLE	LIGHTSOURCE LUMEN OUTPUT [lm]	LUMINAIRE LUMEN OUTPUT [lm]	COLOUR / FINISH	PART NUMBER	UKCA
Power LED 220-240 V 50/60 Hz - through-wiring											
64	I	✓	80	5700	ARRAY	-	-	9900	■	GWS4122BA857	✓
64	I	✓	80	5700	ASYMM	-	-	8900	■	GWS4122BC857	✓
64	I	✓	80	5700	SYMM	30°	-	9800	■	GWS4122BF857	✓
64	I	✓	80	5700	SYMM	60°	-	9900	■	GWS4122BH857	✓
64	I	✓	80	5700	SYMM	90°	-	9900	■	GWS4122BP857	✓
64	I	✓	80	5700	ELL	-	-	9200	■	GWS4122BQ857	✓
64	I	✓	80	4000	ARRAY	-	-	9900	■	GWS4122BA840	✓
64	I	✓	80	4000	ASYMM	-	-	8900	■	GWS4122BC840	✓
64	I	✓	80	4000	SYMM	30°	-	9800	■	GWS4122BF840	✓
64	I	✓	80	4000	SYMM	60°	-	9900	■	GWS4122BH840	✓
64	I	✓	80	4000	SYMM	90°	-	9900	■	GWS4122BP840	✓
64	I	✓	80	4000	ELL	-	-	9200	■	GWS4122BQ840	✓
64	I	✓	80	3000	ARRAY	-	-	9500	■	GWS4122BA830	✓
64	I	✓	80	3000	ASYMM	-	-	8500	■	GWS4122BC830	✓
64	I	✓	80	3000	SYMM	30°	-	9400	■	GWS4122BF830	✓
64	I	✓	80	3000	SYMM	60°	-	9500	■	GWS4122BH830	✓
64	I	✓	80	3000	SYMM	90°	-	9500	■	GWS4122BP830	✓
64	I	✓	80	3000	ELL	-	-	8800	■	GWS4122BQ830	✓
Power LED dimmable DALI 220-240 V 50/60 Hz - through-wiring											
64	I	✓	80	5700	ARRAY	-	-	9900	■	GWS4123BA857	✓
64	I	✓	80	5700	ASYMM	-	-	8900	■	GWS4123BC857	✓
64	I	✓	80	5700	SYMM	30°	-	9800	■	GWS4123BF857	✓
64	I	✓	80	5700	SYMM	60°	-	9900	■	GWS4123BH857	✓
64	I	✓	80	5700	SYMM	90°	-	9900	■	GWS4123BP857	✓
64	I	✓	80	5700	ELL	-	-	9200	■	GWS4123BQ857	✓
64	I	✓	80	4000	ARRAY	-	-	9900	■	GWS4123BA840	✓
64	I	✓	80	4000	ASYMM	-	-	8900	■	GWS4123BC840	✓
64	I	✓	80	4000	SYMM	30°	-	9800	■	GWS4123BF840	✓
64	I	✓	80	4000	SYMM	60°	-	9900	■	GWS4123BH840	✓
64	I	✓	80	4000	SYMM	90°	-	9900	■	GWS4123BP840	✓
64	I	✓	80	4000	ELL	-	-	9200	■	GWS4123BQ840	✓
64	I	✓	80	3000	ARRAY	-	-	9500	■	GWS4123BA830	✓
64	I	✓	80	3000	ASYMM	-	-	8500	■	GWS4123BC830	✓
64	I	✓	80	3000	SYMM	30°	-	9400	■	GWS4123BF830	✓
64	I	✓	80	3000	SYMM	60°	-	9500	■	GWS4123BH830	✓
64	I	✓	80	3000	SYMM	90°	-	9500	■	GWS4123BP830	✓
64	I	✓	80	3000	ELL	-	-	8800	■	GWS4123BQ830	✓



Optional accessories

DESCRIPTION	COLOR	PART NUMBER	UKCA
SMART [4] 1M			
Replacement glass		GWL1907	✓
Adjustable suspension kit with safety clamp		GWL1901	✓
Floodlight bracket		GWL1943	✓
Pole fixing kit		GWL1926	✓

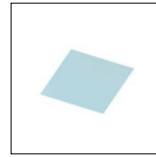

GWL1907

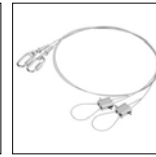

GWL1901



GWL1943

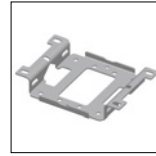

GWL1926

SMART [4] 2M

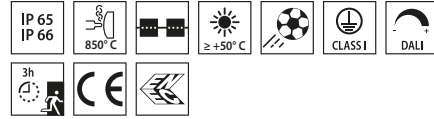

Scan the QR-code for the latest information

■ Grey RAL 7035 / Grey RAL7035 /

LED device suitable for the indoor lighting of industries and sports facilities

- Body in "Halogen-free" nylon loaded with grey glass fibre (RAL7035) with vent and anti-condensation device, heat sink in aluminium alloy EN AB 44300
- Available in 3 sizes: 1M, 2M and 4M
- Available in 3 versions: HE (High Efficiency), HLO (High Lumen Output) and DALI with integrated emergency kit
- Available in 3000K, 4000K and 5700K with CRI ≥80
- Available with integrated On/Off or DALI driver
- The version with through wiring has pre-wired mechanical and electrical connection components
- It is equipped with a dual optical system that includes a metallic reflector with ARRAY optics and a metallic reflector with UV stabilized PMMA lenses, with high efficiency, which allow a wide variety of light distributions 30°, 60°, 90°, Asymmetric and Elliptical
- Suspension, wall and projection appliances can be installed
- Available in DALI version with integrated emergency kit with 3h autonomy

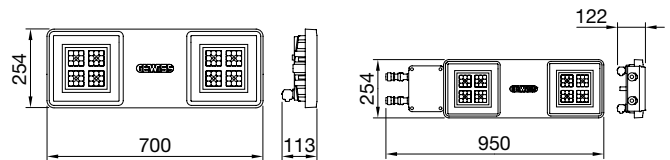

SMART [4] 2M

SMART [4] 2M
EM

Identifying and classifying our optics

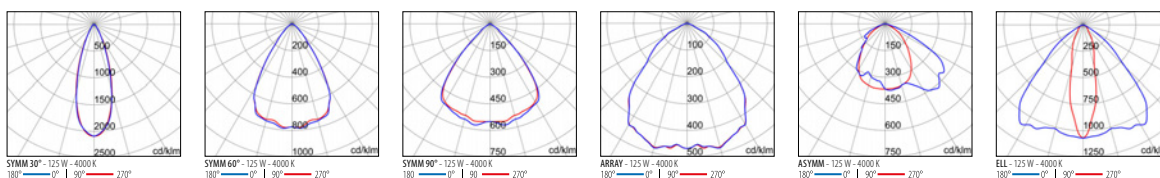

SMART [4] 2M HE

IP66 - IK08 - 850 °C



LUMINAIRE WATTAGE [W]	CLASS	ENEC	CRI	KELVIN	OPTIC	BEAM ANGLE	LIGHTSOURCE LUMEN OUTPUT [lm]	LUMINAIRE LUMEN OUTPUT [lm]	COLOUR / FINISH	PART NUMBER	UKCA
Power LED 220-240 V 50/60 Hz											
95	I	✓	80	5700	ARRAY	-	-	15400	■	GWS4220AA857	✓
95	I	✓	80	5700	ASYMM	-	-	13800	■	GWS4220AC857	✓
95	I	✓	80	5700	SYMM	30°	-	15200	■	GWS4220AF857	✓
95	I	✓	80	5700	SYMM	60°	-	15400	■	GWS4220AH857	✓
95	I	✓	80	5700	SYMM	90°	-	15400	■	GWS4220AP857	✓
95	I	✓	80	5700	ELL	-	-	14200	■	GWS4220AQ857	✓
95	I	✓	80	4000	ARRAY	-	-	15400	■	GWS4220AA840	✓
95	I	✓	80	4000	ASYMM	-	-	13800	■	GWS4220AC840	✓
95	I	✓	80	4000	SYMM	30°	-	15200	■	GWS4220AF840	✓
95	I	✓	80	4000	SYMM	60°	-	15400	■	GWS4220AH840	✓
95	I	✓	80	4000	SYMM	90°	-	15400	■	GWS4220AP840	✓
95	I	✓	80	4000	ELL	-	-	14200	■	GWS4220AQ840	✓
95	I	✓	80	3000	ARRAY	-	-	14600	■	GWS4220AA830	✓
95	I	✓	80	3000	ASYMM	-	-	13000	■	GWS4220AC830	✓
95	I	✓	80	3000	SYMM	30°	-	14400	■	GWS4220AF830	✓
95	I	✓	80	3000	SYMM	60°	-	14600	■	GWS4220AH830	✓
95	I	✓	80	3000	SYMM	90°	-	14600	■	GWS4220AP830	✓
95	I	✓	80	3000	ELL	-	-	13600	■	GWS4220AQ830	✓

Power LED dimmable DALI - 220-240 V 50/60 Hz

95	I	✓	80	5700	ARRAY	-	-	15400	■	GWS4221AA857	✓
95	I	✓	80	5700	ASYMM	-	-	13800	■	GWS4221AC857	✓
95	I	✓	80	5700	SYMM	30°	-	15200	■	GWS4221AF857	✓
95	I	✓	80	5700	SYMM	60°	-	15400	■	GWS4221AH857	✓
95	I	✓	80	5700	SYMM	90°	-	15400	■	GWS4221AP857	✓
95	I	✓	80	5700	ELL	-	-	14200	■	GWS4221AQ857	✓
95	I	✓	80	4000	ARRAY	-	-	15400	■	GWS4221AA840	✓
95	I	✓	80	4000	ASYMM	-	-	13800	■	GWS4221AC840	✓
95	I	✓	80	4000	SYMM	30°	-	15200	■	GWS4221AF840	✓
95	I	✓	80	4000	SYMM	60°	-	15400	■	GWS4221AH840	✓
95	I	✓	80	4000	SYMM	90°	-	15400	■	GWS4221AP840	✓
95	I	✓	80	4000	ELL	-	-	14200	■	GWS4221AQ840	✓
95	I	✓	80	3000	ARRAY	-	-	14600	■	GWS4221AA830	✓
95	I	✓	80	3000	ASYMM	-	-	13000	■	GWS4221AC830	✓
95	I	✓	80	3000	SYMM	30°	-	14400	■	GWS4221AF830	✓
95	I	✓	80	3000	SYMM	60°	-	14600	■	GWS4221AH830	✓
95	I	✓	80	3000	SYMM	90°	-	14600	■	GWS4221AP830	✓
95	I	✓	80	3000	ELL	-	-	13600	■	GWS4221AQ830	✓

SMART [4] 2M HE EM

IP65 - IK08 - 850 °C

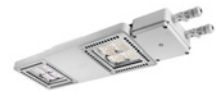

LUMINAIRE WATTAGE [W]	CLASS	ENEC	CRI	KELVIN	OPTIC	BEAM ANGLE	LIGHTSOURCE LUMEN OUTPUT [lm]	LUMINAIRE LUMEN OUTPUT [lm]	COLOUR / FINISH	PART NUMBER	UKCA
Power LED - dimmable DALI - emergency 3h - 220-240 V 50/60 Hz											
95	I	-	80	5700	ARRAY	-	-	15400	■	GWS4224AA857	✓
95	I	-	80	5700	ASYMM	-	-	13800	■	GWS4224AC857	✓
95	I	-	80	5700	SYMM	30°	-	15200	■	GWS4224AF857	✓
95	I	-	80	5700	SYMM	60°	-	15400	■	GWS4224AH857	✓
95	I	-	80	5700	SYMM	90°	-	15400	■	GWS4224AP857	✓
95	I	-	80	5700	ELL	-	-	14200	■	GWS4224AQ857	✓
95	I	-	80	4000	ARRAY	-	-	15400	■	GWS4224AA840	✓
95	I	-	80	4000	ASYMM	-	-	13800	■	GWS4224AC840	✓
95	I	-	80	4000	SYMM	30°	-	15200	■	GWS4224AF840	✓
95	I	-	80	4000	SYMM	60°	-	15400	■	GWS4224AH840	✓
95	I	-	80	4000	SYMM	90°	-	15400	■	GWS4224AP840	✓
95	I	-	80	4000	ELL	-	-	14200	■	GWS4224AQ840	✓
95	I	-	80	3000	ARRAY	-	-	14600	■	GWS4224AA830	✓
95	I	-	80	3000	ASYMM	-	-	13000	■	GWS4224AC830	✓
95	I	-	80	3000	SYMM	30°	-	14400	■	GWS4224AF830	✓
95	I	-	80	3000	SYMM	60°	-	14600	■	GWS4224AH830	✓
95	I	-	80	3000	SYMM	90°	-	14600	■	GWS4224AP830	✓
95	I	-	80	3000	ELL	-	-	13600	■	GWS4224AQ830	✓

SMART [4] 2M HE TW

IP66 - IK08 - 850 °C



LUMINAIRE WATTAGE (W)	CLASS	ENEC	CRI	KELVIN	OPTIC	BEAM ANGLE	LIGHTSOURCE LUMEN OUTPUT (lm)	LUMINAIRE LUMEN OUTPUT (lm)	COLOUR / FINISH	PART NUMBER	UKCA
Power LED 220-240 V 50/60 Hz - through-wiring											
95	I	✓	80	5700	ARRAY	-	-	15400	■	GWS4222AA857	✓
95	I	✓	80	5700	ASYMM	-	-	13800	■	GWS4222AC857	✓
95	I	✓	80	5700	SYMM	30°	-	15200	■	GWS4222AF857	✓
95	I	✓	80	5700	SYMM	60°	-	15400	■	GWS4222AH857	✓
95	I	✓	80	5700	SYMM	90°	-	15400	■	GWS4222AP857	✓
95	I	✓	80	5700	ELL	-	-	14200	■	GWS4222AQ857	✓
95	I	✓	80	4000	ARRAY	-	-	15400	■	GWS4222AA840	✓
95	I	✓	80	4000	ASYMM	-	-	13800	■	GWS4222AC840	✓
95	I	✓	80	4000	SYMM	30°	-	15200	■	GWS4222AF840	✓
95	I	✓	80	4000	SYMM	60°	-	15400	■	GWS4222AH840	✓
95	I	✓	80	4000	SYMM	90°	-	15400	■	GWS4222AP840	✓
95	I	✓	80	4000	ELL	-	-	14200	■	GWS4222AQ840	✓
95	I	✓	80	3000	ARRAY	-	-	14600	■	GWS4222AA830	✓
95	I	✓	80	3000	ASYMM	-	-	13000	■	GWS4222AC830	✓
95	I	✓	80	3000	SYMM	30°	-	14400	■	GWS4222AF830	✓
95	I	✓	80	3000	SYMM	60°	-	14600	■	GWS4222AH830	✓
95	I	✓	80	3000	SYMM	90°	-	14600	■	GWS4222AP830	✓
95	I	✓	80	3000	ELL	-	-	13600	■	GWS4222AQ830	✓

Power LED dimmable DALI - 220-240 V 50/60 Hz - through-wiring											
95	I	✓	80	5700	ARRAY	-	-	15400	■	GWS4223AA857	✓
95	I	✓	80	5700	ASYMM	-	-	13800	■	GWS4223AC857	✓
95	I	✓	80	5700	SYMM	30°	-	15200	■	GWS4223AF857	✓
95	I	✓	80	5700	SYMM	60°	-	15400	■	GWS4223AH857	✓
95	I	✓	80	5700	SYMM	90°	-	15400	■	GWS4223AP857	✓
95	I	✓	80	5700	ELL	-	-	14200	■	GWS4223AQ857	✓
95	I	✓	80	4000	ARRAY	-	-	15400	■	GWS4223AA840	✓
95	I	✓	80	4000	ASYMM	-	-	13800	■	GWS4223AC840	✓
95	I	✓	80	4000	SYMM	30°	-	15200	■	GWS4223AF840	✓
95	I	✓	80	4000	SYMM	60°	-	15400	■	GWS4223AH840	✓
95	I	✓	80	4000	SYMM	90°	-	15400	■	GWS4223AP840	✓
95	I	✓	80	4000	ELL	-	-	14200	■	GWS4223AQ840	✓
95	I	✓	80	3000	ARRAY	-	-	14600	■	GWS4223AA830	✓
95	I	✓	80	3000	ASYMM	-	-	13000	■	GWS4223AC830	✓
95	I	✓	80	3000	SYMM	30°	-	14400	■	GWS4223AF830	✓
95	I	✓	80	3000	SYMM	60°	-	14600	■	GWS4223AH830	✓
95	I	✓	80	3000	SYMM	90°	-	14600	■	GWS4223AP830	✓
95	I	✓	80	3000	ELL	-	-	13600	■	GWS4223AQ830	✓

SMART [4] 2M HLO

IP66 - IK08 - 850 °C



LUMINAIRE WATTAGE [W]	CLASS	ENEC	CRI	KELVIN	OPTIC	BEAM ANGLE	LIGHTSOURCE LUMEN OUTPUT (lm)	LUMINAIRE LUMEN OUTPUT (lm)	COLOUR / FINISH	PART NUMBER	UKCA
Power LED 220-240 V 50/60 Hz											
125	I	✓	80	5700	ARRAY	-	-	19800	■	GWS4220BA857	✓
125	I	✓	80	5700	ASYMM	-	-	17800	■	GWS4220BC857	✓
125	I	✓	80	5700	SYMM	30°	-	19600	■	GWS4220BF857	✓
125	I	✓	80	5700	SYMM	60°	-	19800	■	GWS4220BH857	✓
125	I	✓	80	5700	SYMM	90°	-	19800	■	GWS4220BP857	✓
125	I	✓	80	5700	ELL	-	-	18400	■	GWS4220BQ857	✓
125	I	✓	80	4000	ARRAY	-	-	19800	■	GWS4220BA840	✓
125	I	✓	80	4000	ASYMM	-	-	17800	■	GWS4220BC840	✓
125	I	✓	80	4000	SYMM	30°	-	19600	■	GWS4220BF840	✓
125	I	✓	80	4000	SYMM	60°	-	19800	■	GWS4220BH840	✓
125	I	✓	80	4000	SYMM	90°	-	19800	■	GWS4220BP840	✓
125	I	✓	80	4000	ELL	-	-	18400	■	GWS4220BQ840	✓
125	I	✓	80	3000	ARRAY	-	-	19000	■	GWS4220BA830	✓
125	I	✓	80	3000	ASYMM	-	-	17000	■	GWS4220BC830	✓
125	I	✓	80	3000	SYMM	30°	-	18800	■	GWS4220BF830	✓
125	I	✓	80	3000	SYMM	60°	-	19000	■	GWS4220BH830	✓
125	I	✓	80	3000	SYMM	90°	-	19000	■	GWS4220BP830	✓
125	I	✓	80	3000	ELL	-	-	17600	■	GWS4220BQ830	✓
Power LED dimmable DALI - 220-240 V 50/60 Hz											
125	I	✓	80	5700	ARRAY	-	-	19800	■	GWS4221BA857	✓
125	I	✓	80	5700	ASYMM	-	-	17800	■	GWS4221BC857	✓
125	I	✓	80	5700	SYMM	30°	-	19600	■	GWS4221BF857	✓
125	I	✓	80	5700	SYMM	60°	-	19800	■	GWS4221BH857	✓
125	I	✓	80	5700	SYMM	90°	-	19800	■	GWS4221BP857	✓
125	I	✓	80	5700	ELL	-	-	18400	■	GWS4221BQ857	✓
125	I	✓	80	4000	ARRAY	-	-	19800	■	GWS4221BA840	✓
125	I	✓	80	4000	ASYMM	-	-	17800	■	GWS4221BC840	✓
125	I	✓	80	4000	SYMM	30°	-	19600	■	GWS4221BF840	✓
125	I	✓	80	4000	SYMM	60°	-	19800	■	GWS4221BH840	✓
125	I	✓	80	4000	SYMM	90°	-	19800	■	GWS4221BP840	✓
125	I	✓	80	4000	ELL	-	-	18400	■	GWS4221BQ840	✓
125	I	✓	80	3000	ARRAY	-	-	19000	■	GWS4221BA830	✓
125	I	✓	80	3000	ASYMM	-	-	17000	■	GWS4221BC830	✓
125	I	✓	80	3000	SYMM	30°	-	18800	■	GWS4221BF830	✓
125	I	✓	80	3000	SYMM	60°	-	19000	■	GWS4221BH830	✓
125	I	✓	80	3000	SYMM	90°	-	19000	■	GWS4221BP830	✓
125	I	✓	80	3000	ELL	-	-	17600	■	GWS4221BQ830	✓

SMART [4] 2M HLO EM

IP65 - IK08 - 850 °C

LUMINAIRE WATTAGE [W]	CLASS	ENEC	CRI	KELVIN	OPTIC	BEAM ANGLE	LIGHTSOURCE LUMEN OUTPUT [lm]	LUMINAIRE LUMEN OUTPUT [lm]	COLOUR / FINISH	PART NUMBER	UKCA
Power LED - dimmable DALI - emergency 3h - 220-240 V 50/60 Hz											
125	I	-	80	5700	ARRAY	-	-	19800	■	GWS4224BA857	✓
125	I	-	80	5700	ASYMM	-	-	17800	■	GWS4224BC857	✓
125	I	-	80	5700	SYMM	30°	-	19600	■	GWS4224BF857	✓
125	I	-	80	5700	SYMM	60°	-	19800	■	GWS4224BH857	✓
125	I	-	80	5700	SYMM	90°	-	19800	■	GWS4224BP857	✓
125	I	-	80	5700	ELL	-	-	18400	■	GWS4224BQ857	✓
125	I	-	80	4000	ARRAY	-	-	19800	■	GWS4224BA840	✓
125	I	-	80	4000	ASYMM	-	-	17800	■	GWS4224BC840	✓
125	I	-	80	4000	SYMM	30°	-	19600	■	GWS4224BF840	✓
125	I	-	80	4000	SYMM	60°	-	19800	■	GWS4224BH840	✓
125	I	-	80	4000	SYMM	90°	-	19800	■	GWS4224BP840	✓
125	I	-	80	4000	ELL	-	-	18400	■	GWS4224BQ840	✓
125	I	-	80	3000	ARRAY	-	-	19000	■	GWS4224BA830	✓
125	I	-	80	3000	ASYMM	-	-	17000	■	GWS4224BC830	✓
125	I	-	80	3000	SYMM	30°	-	18800	■	GWS4224BF830	✓
125	I	-	80	3000	SYMM	60°	-	19000	■	GWS4224BH830	✓
125	I	-	80	3000	SYMM	90°	-	19000	■	GWS4224BP830	✓
125	I	-	80	3000	ELL	-	-	17600	■	GWS4224BQ830	✓

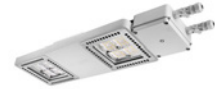

SMART [4] 2M HLO TW

IP66 - IK08 - 850 °C

LUMINAIRE WATTAGE [W]	CLASS	ENEC	CRI	KELVIN	OPTIC	BEAM ANGLE	LIGHTSOURCE LUMEN OUTPUT [lm]	LUMINAIRE LUMEN OUTPUT [lm]	COLOUR / FINISH	PART NUMBER	UKCA
Power LED 220-240 V 50/60 Hz - through-wiring											
125	I	✓	80	5700	ARRAY	-	-	19800	■	GWS4222BA857	✓
125	I	✓	80	5700	ASYMM	-	-	17800	■	GWS4222BC857	✓
125	I	✓	80	5700	SYMM	30°	-	19600	■	GWS4222BF857	✓
125	I	✓	80	5700	SYMM	60°	-	19800	■	GWS4222BH857	✓
125	I	✓	80	5700	SYMM	90°	-	19800	■	GWS4222BP857	✓
125	I	✓	80	5700	ELL	-	-	18400	■	GWS4222BQ857	✓
125	I	✓	80	4000	ARRAY	-	-	19800	■	GWS4222BA840	✓
125	I	✓	80	4000	ASYMM	-	-	17800	■	GWS4222BC840	✓
125	I	✓	80	4000	SYMM	30°	-	19600	■	GWS4222BF840	✓
125	I	✓	80	4000	SYMM	60°	-	19800	■	GWS4222BH840	✓
125	I	✓	80	4000	SYMM	90°	-	19800	■	GWS4222BP840	✓
125	I	✓	80	4000	ELL	-	-	18400	■	GWS4222BQ840	✓
125	I	✓	80	3000	ARRAY	-	-	19000	■	GWS4222BA830	✓
125	I	✓	80	3000	ASYMM	-	-	17000	■	GWS4222BC830	✓
125	I	✓	80	3000	SYMM	30°	-	18800	■	GWS4222BF830	✓
125	I	✓	80	3000	SYMM	60°	-	19000	■	GWS4222BH830	✓
125	I	✓	80	3000	SYMM	90°	-	19000	■	GWS4222BP830	✓
125	I	✓	80	3000	ELL	-	-	17600	■	GWS4222BQ830	✓
Power LED dimmable DALI - 220-240 V 50/60 Hz - through-wiring											
125	I	✓	80	5700	ARRAY	-	-	19800	■	GWS4223BA857	✓
125	I	✓	80	5700	ASYMM	-	-	17800	■	GWS4223BC857	✓
125	I	✓	80	5700	SYMM	30°	-	19600	■	GWS4223BF857	✓
125	I	✓	80	5700	SYMM	60°	-	19800	■	GWS4223BH857	✓
125	I	✓	80	5700	SYMM	90°	-	19800	■	GWS4223BP857	✓
125	I	✓	80	5700	ELL	-	-	18400	■	GWS4223BQ857	✓
125	I	✓	80	4000	ARRAY	-	-	19800	■	GWS4223BA840	✓
125	I	✓	80	4000	ASYMM	-	-	17800	■	GWS4223BC840	✓
125	I	✓	80	4000	SYMM	30°	-	19600	■	GWS4223BF840	✓
125	I	✓	80	4000	SYMM	60°	-	19800	■	GWS4223BH840	✓
125	I	✓	80	4000	SYMM	90°	-	19800	■	GWS4223BP840	✓
125	I	✓	80	4000	ELL	-	-	18400	■	GWS4223BQ840	✓
125	I	✓	80	3000	ARRAY	-	-	19000	■	GWS4223BA830	✓
125	I	✓	80	3000	ASYMM	-	-	17000	■	GWS4223BC830	✓
125	I	✓	80	3000	SYMM	30°	-	18800	■	GWS4223BF830	✓
125	I	✓	80	3000	SYMM	60°	-	19000	■	GWS4223BH830	✓
125	I	✓	80	3000	SYMM	90°	-	19000	■	GWS4223BP830	✓
125	I	✓	80	3000	ELL	-	-	17600	■	GWS4223BQ830	✓



Optional accessories

DESCRIPTION	COLOR	PART NUMBER	UKCA
SMART [4] 2M			
Replacement glass		GWL1907	✓
Adjustable suspension kit with safety clamp		GWL1901	✓
Ceiling-mounting kit		GWL1927	✓
Floodlight bracket		GWL1944	✓
Pole fixing kit		GWL1930	✓

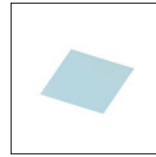

GWL1907

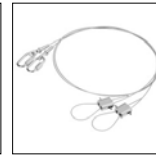

GWL1901



GWL1927



GWL1944

SMART [4] 4M

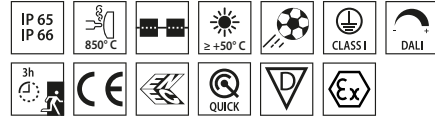

Scan the QR-code for the latest information

■ Grey RAL 7035 / Grey RAL7035 /

LED device suitable for the indoor lighting of industries and sports facilities

- Body in "Halogen-free" nylon loaded with grey glass fibre (RAL7035) with vent and anti-condensation device, heat sink in aluminium alloy EN AB 44300
- Available in 3 sizes: 1M, 2M and 4M
- Available in 3 versions: HE (High Efficiency), HLO (High Lumen Output) and DALI with integrated emergency kit
- Available in 3000K, 4000K and 5700K with CRI ≥80
- Available with integrated On/Off or DALI driver
- The version with through wiring has pre-wired mechanical and electrical connection components
- It is equipped with a dual optical system that includes a metallic reflector with ARRAY optics and a metallic reflector with UV stabilized PMMA lenses, with high efficiency, which allow a wide variety of light distributions 30°, 60°, 90°, Asymmetric and Elliptical
- Suspension, wall and projection appliances can be installed
- Available in DALI version with integrated emergency kit with 3h autonomy



Oratory - Bollate - Italy

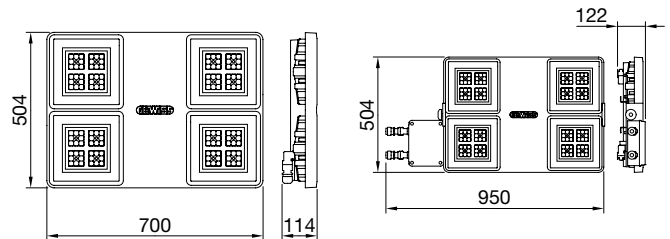

SMART [4] 4M

SMART [4] 4M
EM

Identifying and classifying our optics

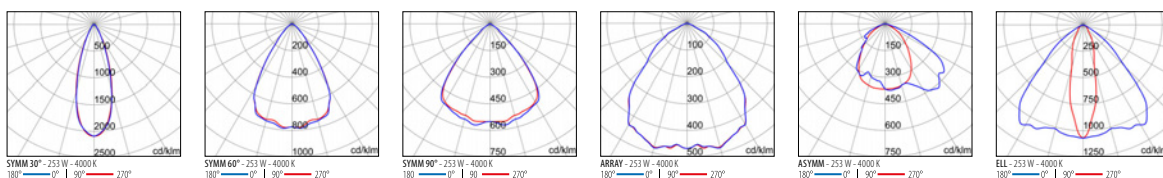

SMART [4] 4M HE

IP66 - IK08 - 850 °C

LUMINAIRE WATTAGE (W)	CLASS	ENEC	CRI	KELVIN	OPTIC	BEAM ANGLE	LIGHTSOURCE LUMEN OUTPUT (lm)	LUMINAIRE LUMEN OUTPUT (lm)	COLOUR / FINISH	PART NUMBER	UKCA
Power LED 220-240 V 50/60 Hz											
189	I	✓	80	5700	ARRAY	-	-	30800	■	GWS4420AA857	✓
189	I	✓	80	5700	ASYMM	-	-	27600	■	GWS4420AC857	✓
189	I	✓	80	5700	SYMM	30°	-	30400	■	GWS4420AF857	✓
189	I	✓	80	5700	SYMM	60°	-	30800	■	GWS4420AH857	✓
189	I	✓	80	5700	SYMM	90°	-	30800	■	GWS4420AP857	✓
189	I	✓	80	5700	ELL	-	-	28400	■	GWS4420AQ857	✓
189	I	✓	80	4000	ARRAY	-	-	30800	■	GWS4420AA840	✓
189	I	✓	80	4000	ASYMM	-	-	27600	■	GWS4420AC840	✓
189	I	✓	80	4000	SYMM	30°	-	30400	■	GWS4420AF840	✓
189	I	✓	80	4000	SYMM	60°	-	30800	■	GWS4420AH840	✓
189	I	✓	80	4000	SYMM	90°	-	30800	■	GWS4420AP840	✓
189	I	✓	80	4000	ELL	-	-	28400	■	GWS4420AQ840	✓
189	I	✓	80	3000	ARRAY	-	-	29200	■	GWS4420AA830	✓
189	I	✓	80	3000	ASYMM	-	-	26000	■	GWS4420AC830	✓
189	I	✓	80	3000	SYMM	30°	-	28800	■	GWS4420AF830	✓
189	I	✓	80	3000	SYMM	60°	-	29200	■	GWS4420AH830	✓
189	I	✓	80	3000	SYMM	90°	-	29200	■	GWS4420AP830	✓
189	I	✓	80	3000	ELL	-	-	27200	■	GWS4420AQ830	✓

Power LED dimmable DALI - 220-240 V 50/60 Hz

189	I	✓	80	5700	ARRAY	-	-	30800	■	GWS4421AA857	✓
189	I	✓	80	5700	ASYMM	-	-	27600	■	GWS4421AC857	✓
189	I	✓	80	5700	SYMM	30°	-	30400	■	GWS4421AF857	✓
189	I	✓	80	5700	SYMM	60°	-	30800	■	GWS4421AH857	✓
189	I	✓	80	5700	SYMM	90°	-	30800	■	GWS4421AP857	✓
189	I	✓	80	5700	ELL	-	-	28400	■	GWS4421AQ857	✓
189	I	✓	80	4000	ARRAY	-	-	30800	■	GWS4421AA840	✓
189	I	✓	80	4000	ASYMM	-	-	27600	■	GWS4421AC840	✓
189	I	✓	80	4000	SYMM	30°	-	30400	■	GWS4421AF840	✓
189	I	✓	80	4000	SYMM	60°	-	30800	■	GWS4421AH840	✓
189	I	✓	80	4000	SYMM	90°	-	30800	■	GWS4421AP840	✓
189	I	✓	80	4000	ELL	-	-	28400	■	GWS4421AQ840	✓
189	I	✓	80	3000	ARRAY	-	-	29200	■	GWS4421AA830	✓
189	I	✓	80	3000	ASYMM	-	-	26000	■	GWS4421AC830	✓
189	I	✓	80	3000	SYMM	30°	-	28800	■	GWS4421AF830	✓
189	I	✓	80	3000	SYMM	60°	-	29200	■	GWS4421AH830	✓
189	I	✓	80	3000	SYMM	90°	-	29200	■	GWS4421AP830	✓
189	I	✓	80	3000	ELL	-	-	27200	■	GWS4421AQ830	✓

SMART [4] 4M HE EM

IP65 - IK08 - 850 °C

LUMINAIRE WATTAGE (W)	CLASS	ENEC	CRI	KELVIN	OPTIC	BEAM ANGLE	LIGHTSOURCE LUMEN OUTPUT (lm)	LUMINAIRE LUMEN OUTPUT (lm)	COLOUR / FINISH	PART NUMBER	UKCA
Power LED - dimmable DALI - emergency 3h - 220-240 V 50/60 Hz											
189	I	-	80	5700	ARRAY	-	-	30800	■	GWS4424AA857	✓
189	I	-	80	5700	ASYMM	-	-	27600	■	GWS4424AC857	✓
189	I	-	80	5700	SYMM	30°	-	30400	■	GWS4424AF857	✓
189	I	-	80	5700	SYMM	60°	-	30800	■	GWS4424AH857	✓
189	I	-	80	5700	SYMM	90°	-	30800	■	GWS4424AP857	✓
189	I	-	80	5700	ELL	-	-	28400	■	GWS4424AQ857	✓
189	I	-	80	4000	ARRAY	-	-	30800	■	GWS4424AA840	✓
189	I	-	80	4000	ASYMM	-	-	27600	■	GWS4424AC840	✓
189	I	-	80	4000	SYMM	30°	-	30400	■	GWS4424AF840	✓
189	I	-	80	4000	SYMM	60°	-	30800	■	GWS4424AH840	✓
189	I	-	80	4000	SYMM	90°	-	30800	■	GWS4424AP840	✓
189	I	-	80	4000	ELL	-	-	28400	■	GWS4424AQ840	✓
189	I	-	80	3000	ARRAY	-	-	29200	■	GWS4424AA830	✓
189	I	-	80	3000	ASYMM	-	-	26000	■	GWS4424AC830	✓
189	I	-	80	3000	SYMM	30°	-	28800	■	GWS4424AF830	✓
189	I	-	80	3000	SYMM	60°	-	29200	■	GWS4424AH830	✓
189	I	-	80	3000	SYMM	90°	-	29200	■	GWS4424AP830	✓
189	I	-	80	3000	ELL	-	-	27200	■	GWS4424AQ830	✓



SMART [4] 4M HE TW

IP66 - IK07 - 850 °C

LUMINAIRE WATTAGE (W)	CLASS	ENEC	CRI	KELVIN	OPTIC	BEAM ANGLE	LIGHTSOURCE LUMEN OUTPUT (lm)	LUMINAIRE LUMEN OUTPUT (lm)	COLOUR / FINISH	PART NUMBER	UKCA
Power LED 220-240 V 50/60 Hz - through-wiring											
189	I	✓	80	5700	ARRAY	-	-	30800	■	GWS4422AA857	✓
189	I	✓	80	5700	ASYMM	-	-	27600	■	GWS4422AC857	✓
189	I	✓	80	5700	SYMM	30°	-	30400	■	GWS4422AF857	✓
189	I	✓	80	5700	SYMM	60°	-	30800	■	GWS4422AH857	✓
189	I	✓	80	5700	SYMM	90°	-	30800	■	GWS4422AP857	✓
189	I	✓	80	5700	ELL	-	-	28400	■	GWS4422AQ857	✓
189	I	✓	80	4000	ARRAY	-	-	30800	■	GWS4422AA840	✓
189	I	✓	80	4000	ASYMM	-	-	27600	■	GWS4422AC840	✓
189	I	✓	80	4000	SYMM	30°	-	30400	■	GWS4422AF840	✓
189	I	✓	80	4000	SYMM	60°	-	30800	■	GWS4422AH840	✓
189	I	✓	80	4000	SYMM	90°	-	30800	■	GWS4422AP840	✓
189	I	✓	80	4000	ELL	-	-	28400	■	GWS4422AQ840	✓
189	I	✓	80	3000	ARRAY	-	-	29200	■	GWS4422AA830	✓
189	I	✓	80	3000	ASYMM	-	-	26000	■	GWS4422AC830	✓
189	I	✓	80	3000	SYMM	30°	-	28800	■	GWS4422AF830	✓
189	I	✓	80	3000	SYMM	60°	-	29200	■	GWS4422AH830	✓
189	I	✓	80	3000	SYMM	90°	-	29200	■	GWS4422AP830	✓
189	I	✓	80	3000	ELL	-	-	27200	■	GWS4422AQ830	✓

Power LED dimmable DALI - 220-240 V 50/60 Hz - through-wiring

189	I	✓	80	5700	ARRAY	-	-	30800	■	GWS4423AA857	✓
189	I	✓	80	5700	ASYMM	-	-	27600	■	GWS4423AC857	✓
189	I	✓	80	5700	SYMM	30°	-	30400	■	GWS4423AF857	✓
189	I	✓	80	5700	SYMM	60°	-	30800	■	GWS4423AH857	✓
189	I	✓	80	5700	SYMM	90°	-	30800	■	GWS4423AP857	✓
189	I	✓	80	5700	ELL	-	-	28400	■	GWS4423AQ857	✓
189	I	✓	80	4000	ARRAY	-	-	30800	■	GWS4423AA840	✓
189	I	✓	80	4000	ASYMM	-	-	27600	■	GWS4423AC840	✓
189	I	✓	80	4000	SYMM	30°	-	30400	■	GWS4423AF840	✓
189	I	✓	80	4000	SYMM	60°	-	30800	■	GWS4423AH840	✓
189	I	✓	80	4000	SYMM	90°	-	30800	■	GWS4423AP840	✓
189	I	✓	80	4000	ELL	-	-	28400	■	GWS4423AQ840	✓
189	I	✓	80	3000	ARRAY	-	-	29200	■	GWS4423AA830	✓
189	I	✓	80	3000	ASYMM	-	-	26000	■	GWS4423AC830	✓
189	I	✓	80	3000	SYMM	30°	-	28800	■	GWS4423AF830	✓
189	I	✓	80	3000	SYMM	60°	-	29200	■	GWS4423AH830	✓
189	I	✓	80	3000	SYMM	90°	-	29200	■	GWS4423AP830	✓
189	I	✓	80	3000	ELL	-	-	27200	■	GWS4423AQ830	✓



SMART [4] 4M HLO

IP66 - IK08 - 850 °C



LUMINAIRE WATTAGE [W]	CLASS	ENEC	CRI	KELVIN	OPTIC	BEAM ANGLE	LIGHTSOURCE LUMEN OUTPUT (lm)	LUMINAIRE LUMEN OUTPUT (lm)	COLOUR / FINISH	PART NUMBER	UKCA
Power LED 220-240 V 50/60 Hz											
253	I	✓	80	5700	ARRAY	-	-	39600	■	GWS4420BA857	✓
253	I	✓	80	5700	ASYMM	-	-	35600	■	GWS4420BC857	✓
253	I	✓	80	5700	SYMM	30°	-	39200	■	GWS4420BF857	✓
253	I	✓	80	5700	SYMM	60°	-	39600	■	GWS4420BH857	✓
253	I	✓	80	5700	SYMM	90°	-	39600	■	GWS4420BP857	✓
253	I	✓	80	5700	ELL	-	-	36800	■	GWS4420BQ857	✓
253	I	✓	80	4000	ARRAY	-	-	39600	■	GWS4420BA840	✓
253	I	✓	80	4000	ASYMM	-	-	35600	■	GWS4420BC840	✓
253	I	✓	80	4000	SYMM	30°	-	39200	■	GWS4420BF840	✓
253	I	✓	80	4000	SYMM	60°	-	39600	■	GWS4420BH840	✓
253	I	✓	80	4000	SYMM	90°	-	39600	■	GWS4420BP840	✓
253	I	✓	80	4000	ELL	-	-	36800	■	GWS4420BQ840	✓
253	I	✓	80	3000	ARRAY	-	-	38000	■	GWS4420BA830	✓
253	I	✓	80	3000	ASYMM	-	-	34000	■	GWS4420BC830	✓
253	I	✓	80	3000	SYMM	30°	-	37600	■	GWS4420BF830	✓
253	I	✓	80	3000	SYMM	60°	-	38000	■	GWS4420BH830	✓
253	I	✓	80	3000	SYMM	90°	-	38000	■	GWS4420BP830	✓
253	I	✓	80	3000	ELL	-	-	35200	■	GWS4420BQ830	✓
Power LED dimmable DALI - 220-240 V 50/60 Hz											
253	I	✓	80	5700	ARRAY	-	-	39600	■	GWS4421BA857	✓
253	I	✓	80	5700	ASYMM	-	-	35600	■	GWS4421BC857	✓
253	I	✓	80	5700	SYMM	30°	-	39200	■	GWS4421BF857	✓
253	I	✓	80	5700	SYMM	60°	-	39600	■	GWS4421BH857	✓
253	I	✓	80	5700	SYMM	90°	-	39600	■	GWS4421BP857	✓
253	I	✓	80	5700	ELL	-	-	36800	■	GWS4421BQ857	✓
253	I	✓	80	4000	ARRAY	-	-	39600	■	GWS4421BA840	✓
253	I	✓	80	4000	ASYMM	-	-	35600	■	GWS4421BC840	✓
253	I	✓	80	4000	SYMM	30°	-	39200	■	GWS4421BF840	✓
253	I	✓	80	4000	SYMM	60°	-	39600	■	GWS4421BH840	✓
253	I	✓	80	4000	SYMM	90°	-	39600	■	GWS4421BP840	✓
253	I	✓	80	4000	ELL	-	-	36800	■	GWS4421BQ840	✓
253	I	✓	80	3000	ARRAY	-	-	38000	■	GWS4421BA830	✓
253	I	✓	80	3000	ASYMM	-	-	34000	■	GWS4421BC830	✓
253	I	✓	80	3000	SYMM	30°	-	37600	■	GWS4421BF830	✓
253	I	✓	80	3000	SYMM	60°	-	38000	■	GWS4421BH830	✓
253	I	✓	80	3000	SYMM	90°	-	38000	■	GWS4421BP830	✓
253	I	✓	80	3000	ELL	-	-	35200	■	GWS4421BQ830	✓

SMART [4] 4M HLO EM

IP65 - IK08 - 850 °C

LUMINAIRE WATTAGE [W]	CLASS	ENEC	CRI	KELVIN	OPTIC	BEAM ANGLE	LIGHTSOURCE LUMEN OUTPUT [lm]	LUMINAIRE LUMEN OUTPUT [lm]	COLOUR / FINISH	PART NUMBER	UKCA
Power LED - dimmable DALI - emergency 3h - 220-240 V 50/60 Hz											
253	I	-	80	5700	ARRAY	-	-	39600	■	GWS4424BA857	✓
253	I	-	80	5700	ASYMM	-	-	35600	■	GWS4424BC857	✓
253	I	-	80	5700	SYMM	30°	-	39200	■	GWS4424BF857	✓
253	I	-	80	5700	SYMM	60°	-	39600	■	GWS4424BH857	✓
253	I	-	80	5700	SYMM	90°	-	39600	■	GWS4424BP857	✓
253	I	-	80	5700	ELL	-	-	36800	■	GWS4424BQ857	✓
253	I	-	80	4000	ARRAY	-	-	39600	■	GWS4424BA840	✓
253	I	-	80	4000	ASYMM	-	-	35600	■	GWS4424BC840	✓
253	I	-	80	4000	SYMM	30°	-	39200	■	GWS4424BF840	✓
253	I	-	80	4000	SYMM	60°	-	39600	■	GWS4424BH840	✓
253	I	-	80	4000	SYMM	90°	-	39600	■	GWS4424BP840	✓
253	I	-	80	4000	ELL	-	-	36800	■	GWS4424BQ840	✓
253	I	-	80	3000	ARRAY	-	-	38000	■	GWS4424BA830	✓
253	I	-	80	3000	ASYMM	-	-	34000	■	GWS4424BC830	✓
253	I	-	80	3000	SYMM	30°	-	37600	■	GWS4424BF830	✓
253	I	-	80	3000	SYMM	60°	-	38000	■	GWS4424BH830	✓
253	I	-	80	3000	SYMM	90°	-	38000	■	GWS4424BP830	✓
253	I	-	80	3000	ELL	-	-	35200	■	GWS4424BQ830	✓



SMART [4] 4M HLO TW

IP66 - IK07 - 850 °C

LUMINAIRE WATTAGE [W]	CLASS	ENEC	CRI	KELVIN	OPTIC	BEAM ANGLE	LIGHTSOURCE LUMEN OUTPUT [lm]	LUMINAIRE LUMEN OUTPUT [lm]	COLOUR / FINISH	PART NUMBER	UKCA
Power LED 220-240 V 50/60 Hz - through-wiring											
253	I	✓	80	5700	ARRAY	-	-	39600	■	GWS4422BA857	✓
253	I	✓	80	5700	ASYMM	-	-	35600	■	GWS4422BC857	✓
253	I	✓	80	5700	SYMM	30°	-	39200	■	GWS4422BF857	✓
253	I	✓	80	5700	SYMM	60°	-	39600	■	GWS4422BH857	✓
253	I	✓	80	5700	SYMM	90°	-	39600	■	GWS4422BP857	✓
253	I	✓	80	5700	ELL	-	-	36800	■	GWS4422BQ857	✓
253	I	✓	80	4000	ARRAY	-	-	39600	■	GWS4422BA840	✓
253	I	✓	80	4000	ASYMM	-	-	35600	■	GWS4422BC840	✓
253	I	✓	80	4000	SYMM	30°	-	39200	■	GWS4422BF840	✓
253	I	✓	80	4000	SYMM	60°	-	39600	■	GWS4422BH840	✓
253	I	✓	80	4000	SYMM	90°	-	39600	■	GWS4422BP840	✓
253	I	✓	80	4000	ELL	-	-	36800	■	GWS4422BQ840	✓
253	I	✓	80	3000	ARRAY	-	-	38000	■	GWS4422BA830	✓
253	I	✓	80	3000	ASYMM	-	-	34000	■	GWS4422BC830	✓
253	I	✓	80	3000	SYMM	30°	-	37600	■	GWS4422BF830	✓
253	I	✓	80	3000	SYMM	60°	-	38000	■	GWS4422BH830	✓
253	I	✓	80	3000	SYMM	90°	-	38000	■	GWS4422BP830	✓
253	I	✓	80	3000	ELL	-	-	35200	■	GWS4422BQ830	✓
Power LED dimmable DALI - 220-240 V 50/60 Hz - through-wiring											
253	I	✓	80	5700	ARRAY	-	-	39600	■	GWS4423BA857	✓
253	I	✓	80	5700	ASYMM	-	-	35600	■	GWS4423BC857	✓
253	I	✓	80	5700	SYMM	30°	-	39200	■	GWS4423BF857	✓
253	I	✓	80	5700	SYMM	60°	-	39600	■	GWS4423BH857	✓
253	I	✓	80	5700	SYMM	90°	-	39600	■	GWS4423BP857	✓
253	I	✓	80	5700	ELL	-	-	36800	■	GWS4423BQ857	✓
253	I	✓	80	4000	ARRAY	-	-	39600	■	GWS4423BA840	✓
253	I	✓	80	4000	ASYMM	-	-	35600	■	GWS4423BC840	✓
253	I	✓	80	4000	SYMM	30°	-	39200	■	GWS4423BF840	✓
253	I	✓	80	4000	SYMM	60°	-	39600	■	GWS4423BH840	✓
253	I	✓	80	4000	SYMM	90°	-	39600	■	GWS4423BP840	✓
253	I	✓	80	4000	ELL	-	-	36800	■	GWS4423BQ840	✓
253	I	✓	80	3000	ARRAY	-	-	38000	■	GWS4423BA830	✓
253	I	✓	80	3000	ASYMM	-	-	34000	■	GWS4423BC830	✓
253	I	✓	80	3000	SYMM	30°	-	37600	■	GWS4423BF830	✓
253	I	✓	80	3000	SYMM	60°	-	38000	■	GWS4423BH830	✓
253	I	✓	80	3000	SYMM	90°	-	38000	■	GWS4423BP830	✓
253	I	✓	80	3000	ELL	-	-	35200	■	GWS4423BQ830	✓



Optional accessories

DESCRIPTION	COLOR	PART NUMBER	UKCA
SMART [4] 4M			
Replacement glass		GWL1907	✓
Adjustable suspension kit with safety clamp		GWL1901	✓
Floodlight bracket		GWL1945	✓
Ceiling-mounting kit		GWL1948	✓

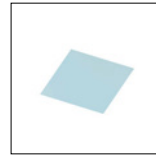

GWL1907

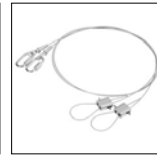

GWL1901



GWL1945

SMART [4] SPECIAL VERSIONS

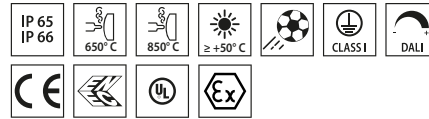

Scan the QR-code for the latest information

■ Grey RAL 7035 / Grey RAL7035 /

LED device suitable for the indoor lighting of industries and sports facilities

- Body in "Halogen-free" nylon loaded with grey glass fibre (RAL7035) with vent and anti-condensation device, heat sink in aluminium alloy EN AB 44300
- Available in 3 sizes: 1M, 2M and 4M (according to version)
- Available in 4000K and 5700K with CRI ≥80 (according to version)
- ATEX: series of LED indoor lighting appliances ideal for use in areas where flammable gases, vapours and dust are present. The electrical connection is via a 3x1.5 mm² H07RN-F cable with anti-condensation device exiting the product via a PG13.5 ATEX certified metal cable gland. The industrial reflector is certified ATEX II 3 G Ex nR IIC T6 Gc - II 3 D Ex tc IIC T65°C Dc
- HACCP: series of indoor LED lighting devices suitable for lighting in the food and beverage industry, ideal for illuminating production areas, warehouses and logistics areas. It is equipped with a double optical system that provides a metallic reflector with ARRAY optics and a metallic reflector with PMMA lenses stabilized at UV, high efficiency and front screen in PMMA
- HT: series of LED indoor appliances suitable for the food industry, production areas or warehouses where critical temperatures develop. Three different sizes available: 1M, 2M and 4M. Operating temperature range "Ta" between -30°C and +60°C
- UL: series of indoor LED lighting devices suitable for lighting of industries and sports facilities. The electrical connection will be via 3x16 AWG tear-proof cable coming out of the product via a PG13.5 plastic cable gland UL certified. Industrial reflector is UL certified UL (UL 1598 - CSA C22.2 No. 250.0-18)
- Available with integrated On/Off or DALI driver (according to version)
- It is equipped with a dual optical system that includes a metallic reflector with ARRAY optics and a metallic reflector with UV stabilized PMMA lenses, with high efficiency, which allow a wide variety of light distributions 30°, 60°, 90°, Asymmetric and Elliptical (according to version)
- Suspension, wall and projection appliances can be installed

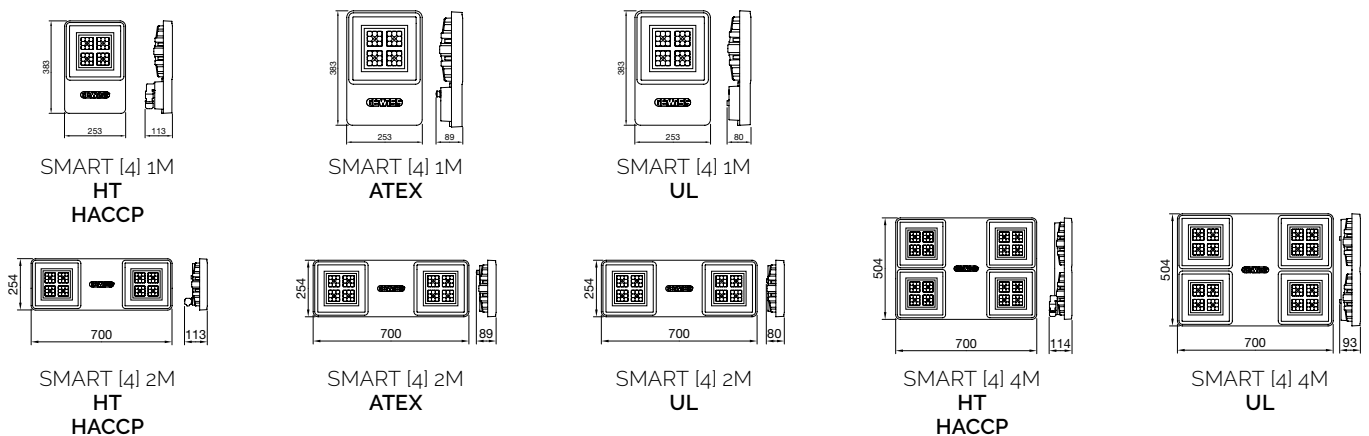

Identifying and classifying our optics

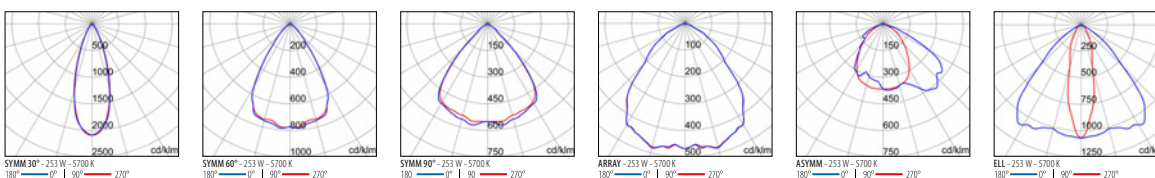

SMART [4] 1M HT

IP66 - IK08 - 850 °C

LUMINAIRE WATTAGE (W)	CLASS	ENEC	CRI	KELVIN	OPTIC	BEAM ANGLE	LIGHTSOURCE LUMEN OUTPUT (lm)	LUMINAIRE LUMEN OUTPUT (lm)	COLOUR / FINISH	PART NUMBER	UKCA
Power LED 220-240 V 50/60 Hz											
48	I	-	80	5700	ARRAY	-	-	7700	■	GWS4120CA857	✓
48	I	-	80	5700	SYMM	60°	-	7700	■	GWS4120CH857	✓
48	I	-	80	5700	SYMM	90°	-	7700	■	GWS4120CP857	✓
48	I	-	80	5700	ELL	-	-	7100	■	GWS4120CQ857	✓
48	I	-	80	4000	ARRAY	-	-	7700	■	GWS4120CA840	✓
48	I	-	80	4000	SYMM	60°	-	7700	■	GWS4120CH840	✓
48	I	-	80	4000	SYMM	90°	-	7700	■	GWS4120CP840	✓
48	I	-	80	4000	ELL	-	-	7100	■	GWS4120CQ840	✓



SMART [4] 1M ATEX

IP66 - IK08 - 850 °C

LUMINAIRE WATTAGE (W)	CLASS	ENEC	CRI	KELVIN	OPTIC	BEAM ANGLE	LIGHTSOURCE LUMEN OUTPUT (lm)	LUMINAIRE LUMEN OUTPUT (lm)	COLOUR / FINISH	PART NUMBER	UKCA
Power LED 220-240 V 50/60 Hz											
64	I	✓	80	5700	ARRAY	-	-	9900	■	GWS4120FA857	✓
64	I	✓	80	5700	ASYMM	-	-	8900	■	GWS4120FC857	✓
64	I	✓	80	5700	SYMM	60°	-	9900	■	GWS4120FH857	✓
64	I	✓	80	5700	SYMM	90°	-	9900	■	GWS4120FP857	✓
64	I	✓	80	4000	ARRAY	-	-	9900	■	GWS4120FA840	✓
64	I	✓	80	4000	ASYMM	-	-	8900	■	GWS4120FC840	✓
64	I	✓	80	4000	SYMM	60°	-	9900	■	GWS4120FH840	✓
64	I	✓	80	4000	SYMM	90°	-	9900	■	GWS4120FP840	✓



SMART [4] 1M UL

IP66 - IK08 - 850 °C

LUMINAIRE WATTAGE (W)	CLASS	ENEC	CRI	KELVIN	OPTIC	BEAM ANGLE	LIGHTSOURCE LUMEN OUTPUT (lm)	LUMINAIRE LUMEN OUTPUT (lm)	COLOUR / FINISH	PART NUMBER	UKCA
Power LED 120-277 V 50/60 Hz											
65	I	-	80	5700	ARRAY	-	-	9900	■	GWS4120GA857	✓
65	I	-	80	5700	SYMM	60°	-	9900	■	GWS4120GH857	✓
65	I	-	80	5700	SYMM	90°	-	9900	■	GWS4120GP857	✓
65	I	-	80	4000	ARRAY	-	-	9900	■	GWS4120GA840	✓
65	I	-	80	4000	SYMM	60°	-	9900	■	GWS4120GH840	✓
65	I	-	80	4000	SYMM	90°	-	9900	■	GWS4120GP840	✓



SMART [4] 1M HACCP

IP65 - IK08 - 650 °C

LUMINAIRE WATTAGE (W)	CLASS	ENEC	CRI	KELVIN	OPTIC	BEAM ANGLE	LIGHTSOURCE LUMEN OUTPUT (lm)	LUMINAIRE LUMEN OUTPUT (lm)	COLOUR / FINISH	PART NUMBER	UKCA
Power LED 220-240 V 50/60 Hz											
64	I	-	80	5700	ARRAY	-	-	9900	■	GWS4120HA857	✓
64	I	-	80	5700	ASYMM	-	-	8900	■	GWS4120HC857	✓
64	I	-	80	5700	SYMM	30°	-	9800	■	GWS4120HF857	✓
64	I	-	80	5700	SYMM	60°	-	9900	■	GWS4120HH857	✓
64	I	-	80	5700	SYMM	90°	-	9900	■	GWS4120HP857	✓
64	I	-	80	5700	ELL	-	-	9200	■	GWS4120HQ857	✓
64	I	-	80	4000	ARRAY	-	-	9900	■	GWS4120HA840	✓
64	I	-	80	4000	ASYMM	-	-	8900	■	GWS4120HC840	✓
64	I	-	80	4000	SYMM	30°	-	9800	■	GWS4120HF840	✓
64	I	-	80	4000	SYMM	60°	-	9900	■	GWS4120HH840	✓
64	I	-	80	4000	SYMM	90°	-	9900	■	GWS4120HP840	✓
64	I	-	80	4000	ELL	-	-	9200	■	GWS4120HQ840	✓

Power LED dimmable DALI - 220-240 V 50/60 Hz

64	I	-	80	5700	ARRAY	-	-	9900	■	GWS4121HA857	✓
64	I	-	80	5700	ASYMM	-	-	8900	■	GWS4121HC857	✓
64	I	-	80	5700	SYMM	30°	-	9800	■	GWS4121HF857	✓
64	I	-	80	5700	SYMM	60°	-	9900	■	GWS4121HH857	✓
64	I	-	80	5700	SYMM	90°	-	9900	■	GWS4121HP857	✓
64	I	-	80	5700	ELL	-	-	9200	■	GWS4121HQ857	✓
64	I	-	80	4000	ARRAY	-	-	9900	■	GWS4121HA840	✓
64	I	-	80	4000	ASYMM	-	-	8900	■	GWS4121HC840	✓
64	I	-	80	4000	SYMM	30°	-	9800	■	GWS4121HF840	✓
64	I	-	80	4000	SYMM	60°	-	9900	■	GWS4121HH840	✓
64	I	-	80	4000	SYMM	90°	-	9900	■	GWS4121HP840	✓
64	I	-	80	4000	ELL	-	-	9200	■	GWS4121HQ840	✓



SMART [4] 2M HT

IP66 - IK08 - 850 °C

LUMINAIRE WATTAGE (W)	CLASS	ENEC	CRI	KELVIN	OPTIC	BEAM ANGLE	LIGHTSOURCE LUMEN OUTPUT (lm)	LUMINAIRE LUMEN OUTPUT (lm)	COLOUR / FINISH	PART NUMBER	UKCA
Power LED 220-240 V 50/60 Hz											
95	I	-	80	5700	ARRAY	-	-	15400	■	GWS4220CA857	✓
95	I	-	80	5700	SYMM	60°	-	15400	■	GWS4220CH857	✓
95	I	-	80	5700	SYMM	90°	-	15400	■	GWS4220CP857	✓
95	I	-	80	5700	ELL	-	-	14200	■	GWS4220CQ857	✓
95	I	-	80	4000	ARRAY	-	-	15400	■	GWS4220CA840	✓
95	I	-	80	4000	SYMM	60°	-	15400	■	GWS4220CH840	✓
95	I	-	80	4000	SYMM	90°	-	15400	■	GWS4220CP840	✓
95	I	-	80	4000	ELL	-	-	14200	■	GWS4220CQ840	✓



SMART [4] 2M ATEX

IP66 - IK08 - 850 °C

LUMINAIRE WATTAGE (W)	CLASS	ENEC	CRI	KELVIN	OPTIC	BEAM ANGLE	LIGHTSOURCE LUMEN OUTPUT (lm)	LUMINAIRE LUMEN OUTPUT (lm)	COLOUR / FINISH	PART NUMBER	UKCA
Power LED 220-240 V 50/60 Hz											
127	I	✓	80	5700	ARRAY	-	-	19800	■	GWS4220FA857	✓
127	I	✓	80	5700	ASYMM	-	-	17800	■	GWS4220FC857	✓
127	I	✓	80	5700	SYMM	60°	-	19800	■	GWS4220FH857	✓
127	I	✓	80	5700	SYMM	90°	-	19800	■	GWS4220FP857	✓
127	I	✓	80	4000	ARRAY	-	-	19800	■	GWS4220FA840	✓
127	I	✓	80	4000	ASYMM	-	-	17800	■	GWS4220FC840	✓
127	I	✓	80	4000	SYMM	60°	-	19800	■	GWS4220FH840	✓
127	I	✓	80	4000	SYMM	90°	-	19800	■	GWS4220FP840	✓



SMART [4] 2M UL

IP66 - IK08 - 850 °C

LUMINAIRE WATTAGE (W)	CLASS	ENEC	CRI	KELVIN	OPTIC	BEAM ANGLE	LIGHTSOURCE LUMEN OUTPUT (lm)	LUMINAIRE LUMEN OUTPUT (lm)	COLOUR / FINISH	PART NUMBER	UKCA
Power LED 120-277 V 50/60 Hz											
129	I	-	80	5700	ARRAY	-	-	19800	■	GWS4220GA857	✓
129	I	-	80	5700	SYMM	60°	-	19800	■	GWS4220GH857	✓
129	I	-	80	5700	SYMM	90°	-	19800	■	GWS4220GP857	✓
129	I	-	80	4000	ARRAY	-	-	19800	■	GWS4220GA840	✓
129	I	-	80	4000	SYMM	60°	-	19800	■	GWS4220GH840	✓
129	I	-	80	4000	SYMM	90°	-	19800	■	GWS4220GP840	✓



SMART [4] 2M HACCP

IP65 - IK08 - 650 °C

LUMINAIRE WATTAGE (W)	CLASS	ENEC	CRI	KELVIN	OPTIC	BEAM ANGLE	LIGHTSOURCE LUMEN OUTPUT (lm)	LUMINAIRE LUMEN OUTPUT (lm)	COLOUR / FINISH	PART NUMBER	UKCA
Power LED 220-240 V 50/60 Hz											
125	I	-	80	5700	ARRAY	-	-	19800	■	GWS4220HA857	✓
125	I	-	80	5700	ASYMM	-	-	17800	■	GWS4220HC857	✓
125	I	-	80	5700	SYMM	30°	-	19600	■	GWS4220HF857	✓
125	I	-	80	5700	SYMM	60°	-	19800	■	GWS4220HH857	✓
125	I	-	80	5700	SYMM	90°	-	19800	■	GWS4220HP857	✓
125	I	-	80	5700	ELL	-	-	18400	■	GWS4220HQ857	✓
125	I	-	80	4000	ARRAY	-	-	19800	■	GWS4220HA840	✓
125	I	-	80	4000	ASYMM	-	-	17800	■	GWS4220HC840	✓
125	I	-	80	4000	SYMM	30°	-	19600	■	GWS4220HF840	✓
125	I	-	80	4000	SYMM	60°	-	19800	■	GWS4220HH840	✓
125	I	-	80	4000	SYMM	90°	-	19800	■	GWS4220HP840	✓
125	I	-	80	4000	ELL	-	-	18400	■	GWS4220HQ840	✓



Power LED dimmable DALI - 220-240 V 50/60 Hz

125	I	-	80	5700	ARRAY	-	-	19800	■	GWS4221HA857	✓
125	I	-	80	5700	ASYMM	-	-	17800	■	GWS4221HC857	✓
125	I	-	80	5700	SYMM	30°	-	19600	■	GWS4221HF857	✓
125	I	-	80	5700	SYMM	60°	-	19800	■	GWS4221HH857	✓
125	I	-	80	5700	SYMM	90°	-	19800	■	GWS4221HP857	✓
125	I	-	80	5700	ELL	-	-	18400	■	GWS4221HQ857	✓
125	I	-	80	4000	ARRAY	-	-	19800	■	GWS4221HA840	✓
125	I	-	80	4000	ASYMM	-	-	17800	■	GWS4221HC840	✓
125	I	-	80	4000	SYMM	30°	-	19600	■	GWS4221HF840	✓
125	I	-	80	4000	SYMM	60°	-	19800	■	GWS4221HH840	✓
125	I	-	80	4000	SYMM	90°	-	19800	■	GWS4221HP840	✓
125	I	-	80	4000	ELL	-	-	18400	■	GWS4221HQ840	✓

SMART [4] 4M HT

IP66 - IK08 - 850 °C

LUMINAIRE WATTAGE (W)	CLASS	ENEC	CRI	KELVIN	OPTIC	BEAM ANGLE	LIGHTSOURCE LUMEN OUTPUT (lm)	LUMINAIRE LUMEN OUTPUT (lm)	COLOUR / FINISH	PART NUMBER	UKCA
Power LED 220-240 V 50/60 Hz											
189	I	-	80	5700	ARRAY	-	-	30800	■	GWS4420CA857	✓
189	I	-	80	5700	SYMM	60°	-	30800	■	GWS4420CH857	✓
189	I	-	80	5700	SYMM	90°	-	30800	■	GWS4420CP857	✓
189	I	-	80	5700	ELL	-	-	28400	■	GWS4420CQ857	✓
189	I	-	80	4000	ARRAY	-	-	30800	■	GWS4420CA840	✓
189	I	-	80	4000	SYMM	60°	-	30800	■	GWS4420CH840	✓
189	I	-	80	4000	SYMM	90°	-	30800	■	GWS4420CP840	✓
189	I	-	80	4000	ELL	-	-	28400	■	GWS4420CQ840	✓



SMART [4] 4M UL

IP66 - IK08 - 850 °C

LUMINAIRE WATTAGE (W)	CLASS	ENEC	CRI	KELVIN	OPTIC	BEAM ANGLE	LIGHTSOURCE LUMEN OUTPUT (lm)	LUMINAIRE LUMEN OUTPUT (lm)	COLOUR / FINISH	PART NUMBER	UKCA
Power LED 120-277 V 50/60 Hz											
256	I	-	80	5700	ARRAY	-	-	39600	■	GWS4420GA857	✓
256	I	-	80	5700	SYMM	60°	-	39600	■	GWS4420GH857	✓
256	I	-	80	5700	SYMM	90°	-	39600	■	GWS4420GP857	✓
256	I	-	80	4000	ARRAY	-	-	39600	■	GWS4420GA840	✓
256	I	-	80	4000	SYMM	60°	-	39600	■	GWS4420GH840	✓
256	I	-	80	4000	SYMM	90°	-	39600	■	GWS4420GP840	✓



SMART [4] 4M HACCP

IP65 - IK08 - 650 °C

LUMINAIRE WATTAGE (W)	CLASS	ENEC	CRI	KELVIN	OPTIC	BEAM ANGLE	LIGHTSOURCE LUMEN OUTPUT (lm)	LUMINAIRE LUMEN OUTPUT (lm)	COLOUR / FINISH	PART NUMBER	UKCA
Power LED 220-240 V 50/60 Hz											
253	I	-	80	5700	ARRAY	-	-	39600	■	GWS4420HA857	✓
253	I	-	80	5700	ASYMM	-	-	35600	■	GWS4420HC857	✓
253	I	-	80	5700	SYMM	30°	-	39200	■	GWS4420HF857	✓
253	I	-	80	5700	SYMM	60°	-	39600	■	GWS4420HH857	✓
253	I	-	80	5700	SYMM	90°	-	39600	■	GWS4420HP857	✓
253	I	-	80	5700	ELL	-	-	36800	■	GWS4420HQ857	✓
253	I	-	80	4000	ARRAY	-	-	39600	■	GWS4420HA840	✓
253	I	-	80	4000	ASYMM	-	-	35600	■	GWS4420HC840	✓
253	I	-	80	4000	SYMM	30°	-	39200	■	GWS4420HF840	✓
253	I	-	80	4000	SYMM	60°	-	39600	■	GWS4420HH840	✓
253	I	-	80	4000	SYMM	90°	-	39600	■	GWS4420HP840	✓
253	I	-	80	4000	ELL	-	-	36800	■	GWS4420HQ840	✓
Power LED dimmable DALI - 220-240 V 50/60 Hz											
253	I	-	80	5700	ARRAY	-	-	39600	■	GWS4421HA857	✓
253	I	-	80	5700	ASYMM	-	-	35600	■	GWS4421HC857	✓
253	I	-	80	5700	SYMM	30°	-	39200	■	GWS4421HF857	✓
253	I	-	80	5700	SYMM	60°	-	39600	■	GWS4421HH857	✓
253	I	-	80	5700	SYMM	90°	-	39600	■	GWS4421HP857	✓
253	I	-	80	5700	ELL	-	-	36800	■	GWS4421HQ857	✓
253	I	-	80	4000	ARRAY	-	-	39600	■	GWS4421HA840	✓
253	I	-	80	4000	ASYMM	-	-	35600	■	GWS4421HC840	✓
253	I	-	80	4000	SYMM	30°	-	39200	■	GWS4421HF840	✓
253	I	-	80	4000	SYMM	60°	-	39600	■	GWS4421HH840	✓
253	I	-	80	4000	SYMM	90°	-	39600	■	GWS4421HP840	✓
253	I	-	80	4000	ELL	-	-	36800	■	GWS4421HQ840	✓



Optional accessories

DESCRIPTION	COLOR	PART NUMBER	UKCA
SMART [4] SPECIAL VERSIONS			
Replacement glass		GWL1907	✓
Adjustable suspension kit with safety clamp		GWL1901	✓
SMART [4] SPECIAL VERSIONS - 1M			
Floodlight bracket		GWL1943	✓
Pole fixing kit		GWL1926	✓
SMART [4] SPECIAL VERSIONS - 2M			
Floodlight bracket		GWL1944	✓
Ceiling-mounting kit		GWL1927	✓
Pole fixing kit		GWL1930	✓
SMART [4] SPECIAL VERSIONS - 4M			
Floodlight bracket		GWL1945	✓
Ceiling-mounting kit		GWL1948	✓

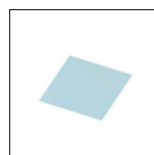

GWL1907



GWL1901

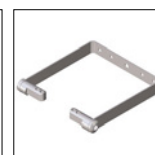

GWL1943

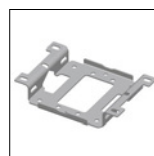

GWL1926

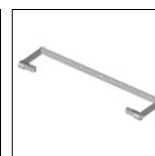

GWL1944



GWL1927



GWL1945

ESALITE HB

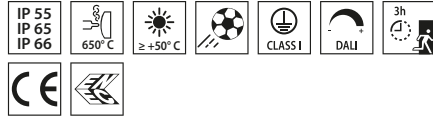

■ GR-RAL9006 / Grey RAL9006 /

Scan the QR-code for the latest information

Industrial LED device made of die-cast EN AB 46100 aluminium with polyester powder coating

- The correct heat dispersion is guaranteed by the special passive heat sink with a very low copper content that offers high qualitative and quantitative performances
- Correct illumination is provided by an optical system composed of different versions of lenses and sealed by an extra-clear tempered glass of 4 mm
- Silicone gaskets, Goretex breathing and anti-condensation device, waterproof connector for 1.5 mm² cables and stainless steel external screws
- The die-cast aluminium structure guarantees optimal performance conditions both at Ta25° and Ta50° thanks to specific thermal sizing tests
- Integrated suspension fixing system thanks to a ring made directly in the die-cast aluminum
- Available permanent emergency version with 3h autonomy, high temperature NiMH batteries and signalling LED for charge status

Industrial

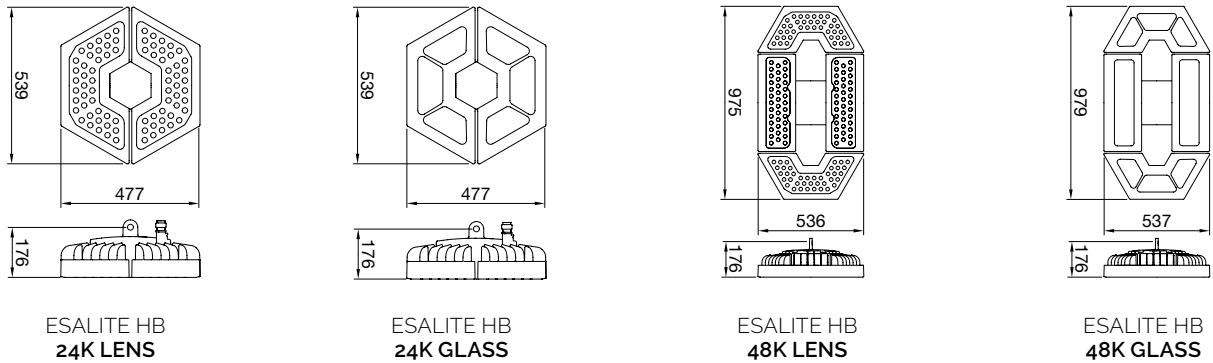
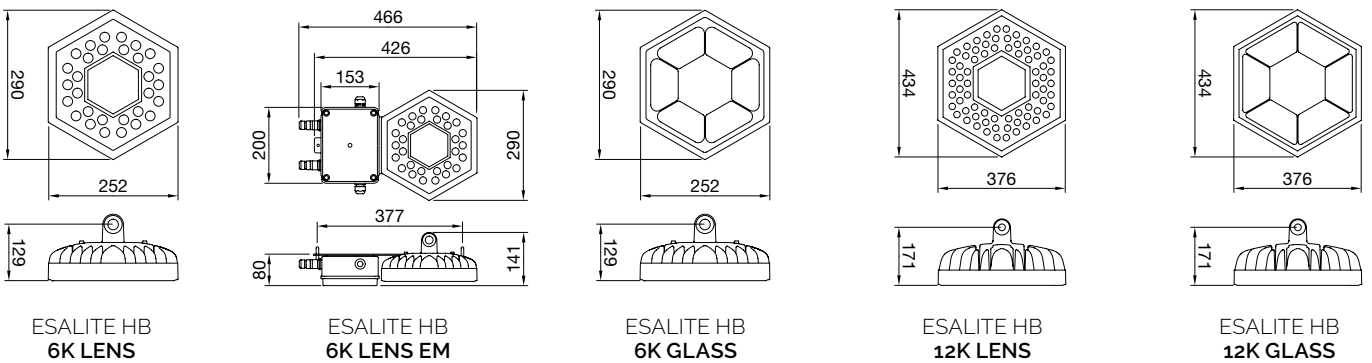

Identifying and classifying our optics

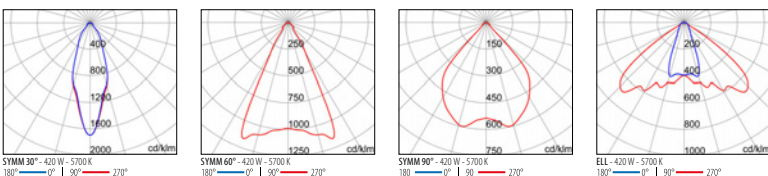

ESALITE HB 6K LENS

IP65 - IK07 - 650 °C

LUMINAIRE WATTAGE (W)	CLASS	ENEC	CRI	KELVIN	OPTIC	BEAM ANGLE	LIGHTSOURCE LUMEN OUTPUT (lm)	LUMINAIRE LUMEN OUTPUT (lm)	COLOUR / FINISH	PART NUMBER	UKCA
Power LED dimmable DALI - 220-240 V 50/60 Hz											
52	I	✓	80	5700	SYMM	30°	-	6200	■	GWS6012GD57K	✓
52	I	✓	80	5700	SYMM	60°	-	6400	■	GWS6013GD57K	✓
52	I	✓	80	5700	SYMM	90°	-	6700	■	GWS6014GD57K	✓
52	I	✓	80	5700	ELL	-	-	6400	■	GWS6015GD57K	✓
52	I	✓	80	4000	SYMM	30°	-	6200	■	GWS6012GD	✓
52	I	✓	80	4000	SYMM	60°	-	6400	■	GWS6013GD	✓
52	I	✓	80	4000	SYMM	90°	-	6700	■	GWS6014GD	✓
52	I	✓	80	4000	ELL	-	-	6400	■	GWS6015GD	✓
52	I	✓	80	3000	SYMM	30°	-	5800	■	GWS6012GD30K	✓
52	I	✓	80	3000	SYMM	60°	-	5900	■	GWS6013GD30K	✓
52	I	✓	80	3000	SYMM	90°	-	6300	■	GWS6014GD30K	✓
52	I	✓	80	3000	ELL	-	-	5900	■	GWS6015GD30K	✓



ESALITE HB 6K LENS EM

IP55 - IK06 - 650 °C

LUMINAIRE WATTAGE (W)	CLASS	ENEC	CRI	KELVIN	OPTIC	BEAM ANGLE	LIGHTSOURCE LUMEN OUTPUT (lm)	LUMINAIRE LUMEN OUTPUT (lm)	COLOUR / FINISH	PART NUMBER	UKCA
Power LED - dimmable DALI 220-240 V 50/60 Hz - emergency 3h											
52	I	-	80	4000	SYMM	90°	-	6700	■	GWS6911	✓



ESALITE HB 6K GLASS

IP66 - IK08

LUMINAIRE WATTAGE (W)	CLASS	ENEC	CRI	KELVIN	OPTIC	BEAM ANGLE	LIGHTSOURCE LUMEN OUTPUT (lm)	LUMINAIRE LUMEN OUTPUT (lm)	COLOUR / FINISH	PART NUMBER	UKCA
Power LED dimmable DALI - 220-240 V 50/60 Hz											
52	I	✓	80	5700	SYMM	30°	-	5700	■	GWS6312GD57K	✓
52	I	✓	80	5700	SYMM	60°	-	5800	■	GWS6313GD57K	✓
52	I	✓	80	5700	SYMM	90°	-	6200	■	GWS6314GD57K	✓
52	I	✓	80	5700	ELL	-	-	5800	■	GWS6315GD57K	✓
52	I	✓	80	4000	SYMM	30°	-	5700	■	GWS6312GD	✓
52	I	✓	80	4000	SYMM	60°	-	5800	■	GWS6313GD	✓
52	I	✓	80	4000	SYMM	90°	-	6200	■	GWS6314GD	✓
52	I	✓	80	4000	ELL	-	-	5800	■	GWS6315GD	✓
52	I	✓	80	3000	SYMM	30°	-	5300	■	GWS6312GD30K	✓
52	I	✓	80	3000	SYMM	60°	-	5400	■	GWS6313GD30K	✓
52	I	✓	80	3000	SYMM	90°	-	5800	■	GWS6314GD30K	✓
52	I	✓	80	3000	ELL	-	-	5400	■	GWS6315GD30K	✓



ESALITE HB 12K LENS

IP65 - IK07 - 650 °C

LUMINAIRE WATTAGE (W)	CLASS	ENEC	CRI	KELVIN	OPTIC	BEAM ANGLE	LIGHTSOURCE LUMEN OUTPUT (lm)	LUMINAIRE LUMEN OUTPUT (lm)	COLOUR / FINISH	PART NUMBER	UKCA
Power LED dimmable DALI - 220-240 V 50/60 Hz											
112	I	✓	80	5700	SYMM	30°	-	12700	■	GWS6022GD57K	✓
112	I	✓	80	5700	SYMM	60°	-	12900	■	GWS6023GD57K	✓
112	I	✓	80	5700	SYMM	90°	-	13700	■	GWS6024GD57K	✓
112	I	✓	80	5700	ELL	-	-	12900	■	GWS6025GD57K	✓
112	I	✓	80	4000	SYMM	30°	-	12700	■	GWS6022GD	✓
112	I	✓	80	4000	SYMM	60°	-	12900	■	GWS6023GD	✓
112	I	✓	80	4000	SYMM	90°	-	13700	■	GWS6024GD	✓
112	I	✓	80	4000	ELL	-	-	12900	■	GWS6025GD	✓
112	I	✓	80	3000	SYMM	30°	-	11800	■	GWS6022GD30K	✓
112	I	✓	80	3000	SYMM	60°	-	12000	■	GWS6023GD30K	✓
112	I	✓	80	3000	SYMM	90°	-	12800	■	GWS6024GD30K	✓
112	I	✓	80	3000	ELL	-	-	12000	■	GWS6025GD30K	✓



ESALITE HB 12K GLASS

IP66 - IK08

LUMINAIRE WATTAGE [W]	CLASS	ENEC	CRI	KELVIN	OPTIC	BEAM ANGLE	LIGHTSOURCE LUMEN OUTPUT [lm]	LUMINAIRE LUMEN OUTPUT [lm]	COLOUR / FINISH	PART NUMBER	UKCA
Power LED dimmable DALI - 220-240 V 50/60 Hz											
112	I	✓	80	5700	SYMM	30°	-	11600	■	GWS6322GD57K	✓
112	I	✓	80	5700	SYMM	60°	-	11900	■	GWS6323GD57K	✓
112	I	✓	80	5700	SYMM	90°	-	12700	■	GWS6324GD57K	✓
112	I	✓	80	5700	ELL	-	-	11900	■	GWS6325GD57K	✓
112	I	✓	80	4000	SYMM	30°	-	11600	■	GWS6322GD	✓
112	I	✓	80	4000	SYMM	60°	-	11900	■	GWS6323GD	✓
112	I	✓	80	4000	SYMM	90°	-	12700	■	GWS6324GD	✓
112	I	✓	80	4000	ELL	-	-	11900	■	GWS6325GD	✓
112	I	✓	80	3000	SYMM	30°	-	10800	■	GWS6322GD30K	✓
112	I	✓	80	3000	SYMM	60°	-	11100	■	GWS6323GD30K	✓
112	I	✓	80	3000	SYMM	90°	-	11800	■	GWS6324GD30K	✓
112	I	✓	80	3000	ELL	-	-	11100	■	GWS6325GD30K	✓



ESALITE HB 16K LENS

IP65 - IK07 - 650 °C

LUMINAIRE WATTAGE [W]	CLASS	ENEC	CRI	KELVIN	OPTIC	BEAM ANGLE	LIGHTSOURCE LUMEN OUTPUT [lm]	LUMINAIRE LUMEN OUTPUT [lm]	COLOUR / FINISH	PART NUMBER	UKCA
Power LED dimmable DALI - 220-240 V 50/60 Hz											
125	I	✓	80	5700	SYMM	30°	-	14400	■	GWS6032GD57K	✓
125	I	✓	80	5700	SYMM	60°	-	14700	■	GWS6033GD57K	✓
125	I	✓	80	5700	SYMM	90°	-	15600	■	GWS6034GD57K	✓
125	I	✓	80	5700	ELL	-	-	14700	■	GWS6035GD57K	✓
125	I	✓	80	4000	SYMM	30°	-	14400	■	GWS6032GD	✓
125	I	✓	80	4000	SYMM	60°	-	14700	■	GWS6033GD	✓
125	I	✓	80	4000	SYMM	90°	-	15600	■	GWS6034GD	✓
125	I	✓	80	4000	ELL	-	-	14700	■	GWS6035GD	✓
125	I	✓	80	3000	SYMM	30°	-	13400	■	GWS6032GD30K	✓
125	I	✓	80	3000	SYMM	60°	-	13700	■	GWS6033GD30K	✓
125	I	✓	80	3000	SYMM	90°	-	14500	■	GWS6034GD30K	✓
125	I	✓	80	3000	ELL	-	-	13700	■	GWS6035GD30K	✓



ESALITE HB 16K GLASS

IP66 - IK08

LUMINAIRE WATTAGE [W]	CLASS	ENEC	CRI	KELVIN	OPTIC	BEAM ANGLE	LIGHTSOURCE LUMEN OUTPUT [lm]	LUMINAIRE LUMEN OUTPUT [lm]	COLOUR / FINISH	PART NUMBER	UKCA
Power LED dimmable DALI - 220-240 V 50/60 Hz											
125	I	✓	80	5700	SYMM	30°	-	13300	■	GWS6332GD57K	✓
125	I	✓	80	5700	SYMM	60°	-	13600	■	GWS6333GD57K	✓
125	I	✓	80	5700	SYMM	90°	-	14400	■	GWS6334GD57K	✓
125	I	✓	80	5700	ELL	-	-	13600	■	GWS6335GD57K	✓
125	I	✓	80	4000	SYMM	30°	-	13300	■	GWS6332GD	✓
125	I	✓	80	4000	SYMM	60°	-	13600	■	GWS6333GD	✓
125	I	✓	80	4000	SYMM	90°	-	14400	■	GWS6334GD	✓
125	I	✓	80	4000	ELL	-	-	13600	■	GWS6335GD	✓
125	I	✓	80	3000	SYMM	30°	-	12300	■	GWS6332GD30K	✓
125	I	✓	80	3000	SYMM	60°	-	12600	■	GWS6333GD30K	✓
125	I	✓	80	3000	SYMM	90°	-	13400	■	GWS6334GD30K	✓
125	I	✓	80	3000	ELL	-	-	12600	■	GWS6335GD30K	✓



ESALITE HB 20K LENS

IP65 - IK07 - 650 °C

LUMINAIRE WATTAGE [W]	CLASS	ENEC	CRI	KELVIN	OPTIC	BEAM ANGLE	LIGHTSOURCE LUMEN OUTPUT [lm]	LUMINAIRE LUMEN OUTPUT [lm]	COLOUR / FINISH	PART NUMBER	UKCA
Power LED dimmable DALI - 220-240 V 50/60 Hz											
148	I	✓	80	5700	SYMM	30°	-	16800	■	GWS6042GD57K	✓
148	I	✓	80	5700	SYMM	60°	-	17200	■	GWS6043GD57K	✓
148	I	✓	80	5700	SYMM	90°	-	18200	■	GWS6044GD57K	✓
148	I	✓	80	5700	ELL	-	-	17200	■	GWS6045GD57K	✓
148	I	✓	80	4000	SYMM	30°	-	16800	■	GWS6042GD	✓
148	I	✓	80	4000	SYMM	60°	-	17200	■	GWS6043GD	✓
148	I	✓	80	4000	SYMM	90°	-	18200	■	GWS6044GD	✓
148	I	✓	80	4000	ELL	-	-	17200	■	GWS6045GD	✓
148	I	✓	80	3000	SYMM	30°	-	15600	■	GWS6042GD30K	✓
148	I	✓	80	3000	SYMM	60°	-	16000	■	GWS6043GD30K	✓
148	I	✓	80	3000	SYMM	90°	-	16900	■	GWS6044GD30K	✓
148	I	✓	80	3000	ELL	-	-	16000	■	GWS6045GD30K	✓



ESALITE HB 20K GLASS

IP66 - IK08

LUMINAIRE WATTAGE [W]	CLASS	ENEC	CRI	KELVIN	OPTIC	BEAM ANGLE	LIGHTSOURCE LUMEN OUTPUT [lm]	LUMINAIRE LUMEN OUTPUT [lm]	COLOUR / FINISH	PART NUMBER	UKCA
Power LED dimmable DALI - 220-240 V 50/60 Hz											
148	I	✓	80	5700	SYMM	30°	-	15500	■	GWS6342GD57K	✓
148	I	✓	80	5700	SYMM	60°	-	15800	■	GWS6343GD57K	✓
148	I	✓	80	5700	SYMM	90°	-	16800	■	GWS6344GD57K	✓
148	I	✓	80	5700	ELL	-	-	15800	■	GWS6345GD57K	✓
148	I	✓	80	4000	SYMM	30°	-	15500	■	GWS6342GD	✓
148	I	✓	80	4000	SYMM	60°	-	15800	■	GWS6343GD	✓
148	I	✓	80	4000	SYMM	90°	-	16800	■	GWS6344GD	✓
148	I	✓	80	4000	ELL	-	-	15800	■	GWS6345GD	✓
148	I	✓	80	3000	SYMM	30°	-	14400	■	GWS6342GD30K	✓
148	I	✓	80	3000	SYMM	60°	-	14700	■	GWS6343GD30K	✓
148	I	✓	80	3000	SYMM	90°	-	15600	■	GWS6344GD30K	✓
148	I	✓	80	3000	ELL	-	-	14700	■	GWS6345GD30K	✓



ESALITE HB 24K LENS

IP65 - IK07 - 650 °C

LUMINAIRE WATTAGE [W]	CLASS	ENEC	CRI	KELVIN	OPTIC	BEAM ANGLE	LIGHTSOURCE LUMEN OUTPUT [lm]	LUMINAIRE LUMEN OUTPUT [lm]	COLOUR / FINISH	PART NUMBER	UKCA
Power LED dimmable DALI - 220-240 V 50/60 Hz											
210	I	✓	80	5700	SYMM	30°	-	23600	■	GWS6052GD57K	✓
210	I	✓	80	5700	SYMM	60°	-	24100	■	GWS6053GD57K	✓
210	I	✓	80	5700	SYMM	90°	-	25600	■	GWS6054GD57K	✓
210	I	✓	80	5700	ELL	-	-	24100	■	GWS6055GD57K	✓
210	I	✓	80	4000	SYMM	30°	-	23600	■	GWS6052GD	✓
210	I	✓	80	4000	SYMM	60°	-	24100	■	GWS6053GD	✓
210	I	✓	80	4000	SYMM	90°	-	25600	■	GWS6054GD	✓
210	I	✓	80	4000	ELL	-	-	24100	■	GWS6055GD	✓
210	I	✓	80	3000	SYMM	30°	-	21900	■	GWS6052GD30K	✓
210	I	✓	80	3000	SYMM	60°	-	22400	■	GWS6053GD30K	✓
210	I	✓	80	3000	SYMM	90°	-	23800	■	GWS6054GD30K	✓
210	I	✓	80	3000	ELL	-	-	22400	■	GWS6055GD30K	✓



ESALITE HB 24K GLASS

IP66 - IK08



LUMINAIRE WATTAGE (W)	CLASS	ENEC	CRI	KELVIN	OPTIC	BEAM ANGLE	LIGHTSOURCE LUMEN OUTPUT (lm)	LUMINAIRE LUMEN OUTPUT (lm)	COLOUR / FINISH	PART NUMBER	UKCA
Power LED dimmable DALI - 220-240 V 50/60 Hz											
210	I	✓	80	5700	SYMM	30°	-	21700	■	GWS6352GD57K	✓
210	I	✓	80	5700	SYMM	60°	-	22200	■	GWS6353GD57K	✓
210	I	✓	80	5700	SYMM	90°	-	23600	■	GWS6354GD57K	✓
210	I	✓	80	5700	ELL	-	-	22200	■	GWS6355GD57K	✓
210	I	✓	80	4000	SYMM	30°	-	21700	■	GWS6352GD	✓
210	I	✓	80	4000	SYMM	60°	-	22200	■	GWS6353GD	✓
210	I	✓	80	4000	SYMM	90°	-	23600	■	GWS6354GD	✓
210	I	✓	80	4000	ELL	-	-	22200	■	GWS6355GD	✓
210	I	✓	80	3000	SYMM	30°	-	20200	■	GWS6352GD30K	✓
210	I	✓	80	3000	SYMM	60°	-	20600	■	GWS6353GD30K	✓
210	I	✓	80	3000	SYMM	90°	-	21900	■	GWS6354GD30K	✓
210	I	✓	80	3000	ELL	-	-	20600	■	GWS6355GD30K	✓

ESALITE HB 48K LENS

IP65 - IK07 - 650 °C



LUMINAIRE WATTAGE (W)	CLASS	ENEC	CRI	KELVIN	OPTIC	BEAM ANGLE	LIGHTSOURCE LUMEN OUTPUT (lm)	LUMINAIRE LUMEN OUTPUT (lm)	COLOUR / FINISH	PART NUMBER	UKCA
Power LED dimmable DALI - 220-240 V 50/60 Hz											
420	I	-	80	5700	SYMM	30°	-	47200	■	GWS6082GD57K	✓
420	I	-	80	5700	SYMM	60°	-	48300	■	GWS6083GD57K	✓
420	I	-	80	5700	SYMM	90°	-	51300	■	GWS6084GD57K	✓
420	I	-	80	5700	ELL	-	-	48300	■	GWS6085GD57K	✓
420	I	-	80	4000	SYMM	30°	-	47200	■	GWS6082GD	✓
420	I	-	80	4000	SYMM	60°	-	48300	■	GWS6083GD	✓
420	I	-	80	4000	SYMM	90°	-	51300	■	GWS6084GD	✓
420	I	-	80	4000	ELL	-	-	48300	■	GWS6085GD	✓
420	I	-	80	3000	SYMM	30°	-	43900	■	GWS6082GD30K	✓
420	I	-	80	3000	SYMM	60°	-	44900	■	GWS6083GD30K	✓
420	I	-	80	3000	SYMM	90°	-	47700	■	GWS6084GD30K	✓
420	I	-	80	3000	ELL	-	-	44900	■	GWS6085GD30K	✓

ESALITE HB 48K GLASS

IP66 - IK08

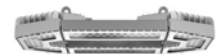

LUMINAIRE WATTAGE (W)	CLASS	ENEC	CRI	KELVIN	OPTIC	BEAM ANGLE	LIGHTSOURCE LUMEN OUTPUT (lm)	LUMINAIRE LUMEN OUTPUT (lm)	COLOUR / FINISH	PART NUMBER	UKCA
Power LED dimmable DALI - 220-240 V 50/60 Hz											
420	I	-	80	5700	SYMM	30°	-	43500	■	GWS6382GD57K	✓
420	I	-	80	5700	SYMM	60°	-	43500	■	GWS6383GD57K	✓
420	I	-	80	5700	SYMM	90°	-	43500	■	GWS6384GD57K	✓
420	I	-	80	5700	ELL	-	-	43500	■	GWS6385GD57K	✓
420	I	-	80	4000	SYMM	30°	-	43500	■	GWS6382GD	✓
420	I	-	80	4000	SYMM	60°	-	43500	■	GWS6383GD	✓
420	I	-	80	4000	SYMM	90°	-	43500	■	GWS6384GD	✓
420	I	-	80	4000	ELL	-	-	43500	■	GWS6385GD	✓
420	I	-	80	3000	SYMM	30°	-	40400	■	GWS6382GD30K	✓
420	I	-	80	3000	SYMM	60°	-	40400	■	GWS6383GD30K	✓
420	I	-	80	3000	SYMM	90°	-	40400	■	GWS6384GD30K	✓
420	I	-	80	3000	ELL	-	-	40400	■	GWS6385GD30K	✓

Optional accessories

DESCRIPTION	COLOR	PART NUMBER	UKCA
ESALITE HB			
Suspension kit for 6K version		GWS6921	✓
Genovese chain 50 m		GWS6922	✓
Metal S hooks for suspension - 20 pieces		GWS6923	✓
Floodlight bracket for 12K/16K/20K versions		GWS6924	✓
Floodlight bracket for 24K version		GWS6925	✓
Carabiner hook - 20 pieces		GWS6926	✓

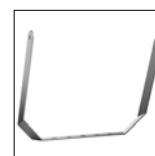

GWS6924
GWS6925

ELIA HL



Scan the QR-code for the latest information

■ Black RAL 9017 / Black RAL9017 /

LED highbay designed for indoor industrial, logistics and tertiary applications, where efficiency, high luminous output, precision and resistance are required

- Available in 3 power steps (120 W, 150 W and 200 W) with a standard colour temperature of 4,000 K (neutral white) and a colour rendering index of 80, the range allows for great flexibility with its multiple possible combinations: 3 optics options (60°, 90° and 120° beam angles in polycarbonate lenses) and 2 integrated power supply options (On/Off and DALI)
- Thanks to its black powder-coated die-cast aluminium body with incorporated heatsink, it is tough, durable (IP65 and IK08) and able to withstand harsh environmental conditions (such as ambient temperature variations from -30°C to +50°C)
- The luminaire can be suspension-mounted through the hook attachment integrated into the upper part of the device

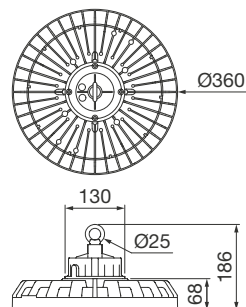

ELIA HL
ON/OFF

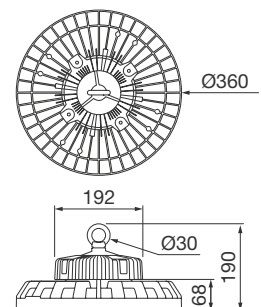

ELIA HL
DALI

ELIA HL M2 120W

IP65 - IK08 - 750 °C

LUMINAIRE WATTAGE [W]	CLASS	ENEC	CRI	KELVIN	OPTIC	BEAM ANGLE	LIGHTSOURCE LUMEN OUTPUT (lm)	LUMINAIRE LUMEN OUTPUT (lm)	COLOUR / FINISH	PART NUMBER	UKCA
Power LED 100-240 V 50/60 Hz											
120	I	✓	80	4000	SYMM	60°	-	17900	■	GWF1000MH840	✓
120	I	✓	80	4000	SYMM	90°	-	18200	■	GWF1000ML840	✓
120	I	✓	80	4000	SYMM	120°	-	18000	■	GWF1000MM840	✓
Power LED dimmable DALI - 220-240 V 50/60 Hz											
120	I	✓	80	4000	SYMM	60°	-	17900	■	GWF1001MH840	✓
120	I	✓	80	4000	SYMM	90°	-	18200	■	GWF1001ML840	✓
120	I	✓	80	4000	SYMM	120°	-	18000	■	GWF1001MM840	✓



ELIA HL M3 150W

IP65 - IK08 - 750 °C

LUMINAIRE WATTAGE [W]	CLASS	ENEC	CRI	KELVIN	OPTIC	BEAM ANGLE	LIGHTSOURCE LUMEN OUTPUT (lm)	LUMINAIRE LUMEN OUTPUT (lm)	COLOUR / FINISH	PART NUMBER	UKCA
Power LED 100-240 V 50/60 Hz											
150	I	✓	80	4000	SYMM	60°	-	22400	■	GWF1000NH840	✓
150	I	✓	80	4000	SYMM	90°	-	22800	■	GWF1000NL840	✓
150	I	✓	80	4000	SYMM	120°	-	22500	■	GWF1000NM840	✓
Power LED dimmable DALI - 220-240 V 50/60 Hz											
150	I	✓	80	4000	SYMM	60°	-	22400	■	GWF1001NH840	✓
150	I	✓	80	4000	SYMM	90°	-	22800	■	GWF1001NL840	✓
150	I	✓	80	4000	SYMM	120°	-	22500	■	GWF1001NM840	✓



ELIA HL L2 200W

IP65 - IK08 - 750 °C

LUMINAIRE WATTAGE [W]	CLASS	ENEC	CRI	KELVIN	OPTIC	BEAM ANGLE	LIGHTSOURCE LUMEN OUTPUT (lm)	LUMINAIRE LUMEN OUTPUT (lm)	COLOUR / FINISH	PART NUMBER	UKCA
Power LED 100-240 V 50/60 Hz											
200	I	✓	80	4000	SYMM	60°	-	29800	■	GWF1000QH840	✓
200	I	✓	80	4000	SYMM	90°	-	30300	■	GWF1000QL840	✓
200	I	✓	80	4000	SYMM	120°	-	30000	■	GWF1000QM840	✓
Power LED dimmable DALI - 220-240 V 50/60 Hz											
200	I	✓	80	4000	SYMM	60°	-	29800	■	GWF1001QH840	✓
200	I	✓	80	4000	SYMM	90°	-	30300	■	GWF1001QL840	✓
200	I	✓	80	4000	SYMM	120°	-	30000	■	GWF1001QM840	✓



SMART [3] PLUS

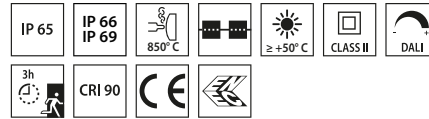

Scan the QR-code for the latest information

■ Grey RAL 7035 / Grey RAL7035 /

Watertight fixture IP66/69 for industrial applications, ideal for production areas, warehouses, and logistics areas

- Designed to replace high-flux fluorescent devices and lowbays up to 10,000lm
- IK08 body in RAL7035 colored self-extinguishing polycarbonate
- Available in 3 sizes: 800, 1200 and 1600 mm
- Available in 3000K, 4000K and 5700K with CRI ≥80 or ≥90
- Available with powers ranging from 25 W to 63 W and flux ranging from 4,000 lm to 10,000 lm
- Mid-power LED flip chip type
- Available with integrated On/Off or DALI driver
- The through wiring version has pre-wired mechanical and electrical connections, allowing up to 25 fixtures installed in a continuous row
- Available in 4 different optical solutions: transparent or opal diffuser in UV-stabilized, self-extinguishing polycarbonate; the transparent version can be equipped with TIR lenses in PMMA with medium or elliptical beam
- The device can be hung or wall-mounted through bracket accessory with a tilt of 30° or 45° on the vertical axis
- Available in DALI version with integrated emergency kit with 3h autonomy
- Available with external emergency kit with 3h autonomy compatible with through wiring versions (to be ordered separately)

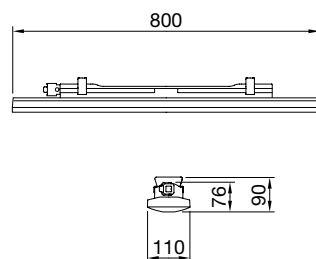

SMART [3] PLUS
800

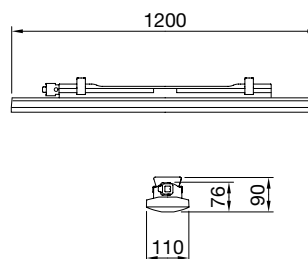

SMART [3] PLUS
1200

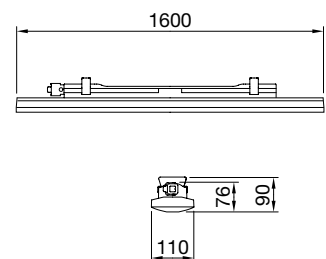

SMART [3] PLUS
1600

SMART [3] PLUS 800 OPAL

IP66/69 - IK08 - 850 °C



LUMINAIRE WATTAGE [W]	CLASS	ENEC	CRI	KELVIN	OPTIC	BEAM ANGLE	LIGHTSOURCE LUMEN OUTPUT [lm]	LUMINAIRE LUMEN OUTPUT [lm]	COLOUR / FINISH	PART NUMBER	UKCA
Power LED 220-240 V 50/60 Hz											
25	II	✓	90	5700	OPAL	-	-	2900	■	GWS3120AP957	✓
25	II	✓	90	4000	OPAL	-	-	2900	■	GWS3120AP940	✓
25	II	✓	90	3000	OPAL	-	-	2700	■	GWS3120AP930	✓
25	II	✓	80	5700	OPAL	-	-	3700	■	GWS3120AP857	✓
25	II	✓	80	4000	OPAL	-	-	3700	■	GWS3120AP840	✓
25	II	✓	80	3000	OPAL	-	-	3500	■	GWS3120AP830	✓
Power LED 220-240 V 50/60 Hz - through-wiring											
25	II	✓	90	5700	OPAL	-	-	2900	■	GWS3122AP957	✓
25	II	✓	90	4000	OPAL	-	-	2900	■	GWS3122AP940	✓
25	II	✓	90	3000	OPAL	-	-	2700	■	GWS3122AP930	✓
25	II	✓	80	5700	OPAL	-	-	3700	■	GWS3122AP857	✓
25	II	✓	80	4000	OPAL	-	-	3700	■	GWS3122AP840	✓
25	II	✓	80	3000	OPAL	-	-	3500	■	GWS3122AP830	✓
Power LED dimmable DALI - 220-240 V 50/60 Hz											
26	II	✓	90	5700	OPAL	-	-	2900	■	GWS3121AP957	✓
26	II	✓	90	4000	OPAL	-	-	2900	■	GWS3121AP940	✓
26	II	✓	90	3000	OPAL	-	-	2700	■	GWS3121AP930	✓
26	II	✓	80	5700	OPAL	-	-	3700	■	GWS3121AP857	✓
26	II	✓	80	4000	OPAL	-	-	3700	■	GWS3121AP840	✓
26	II	✓	80	3000	OPAL	-	-	3500	■	GWS3121AP830	✓
Power LED dimmable DALI 220-240 V 50/60 Hz - through-wiring											
26	II	✓	90	5700	OPAL	-	-	2900	■	GWS3123AP957	✓
26	II	✓	90	4000	OPAL	-	-	2900	■	GWS3123AP940	✓
26	II	✓	90	3000	OPAL	-	-	2700	■	GWS3123AP930	✓
26	II	✓	80	5700	OPAL	-	-	3700	■	GWS3123AP857	✓
26	II	✓	80	4000	OPAL	-	-	3700	■	GWS3123AP840	✓
26	II	✓	80	3000	OPAL	-	-	3500	■	GWS3123AP830	✓

SMART [3] PLUS 800 TRANSPARENT

IP66/69 - IK08 - 850 °C



LUMINAIRE WATTAGE [W]	CLASS	ENEC	CRI	KELVIN	OPTIC	BEAM ANGLE	LIGHTSOURCE LUMEN OUTPUT [lm]	LUMINAIRE LUMEN OUTPUT [lm]	COLOUR / FINISH	PART NUMBER	UKCA
Power LED 220-240 V 50/60 Hz											
25	II	✓	90	5700	TRNSP	-	-	3100	■	GWS3120AT957	✓
25	II	✓	90	4000	TRNSP	-	-	3100	■	GWS3120AT940	✓
25	II	✓	90	3000	TRNSP	-	-	2900	■	GWS3120AT930	✓
25	II	✓	80	5700	TRNSP	-	-	3900	■	GWS3120AT857	✓
25	II	✓	80	4000	TRNSP	-	-	3900	■	GWS3120AT840	✓
25	II	✓	80	3000	TRNSP	-	-	3700	■	GWS3120AT830	✓
Power LED 220-240 V 50/60 Hz - through-wiring											
25	II	✓	90	5700	TRNSP	-	-	3100	■	GWS3122AT957	✓
25	II	✓	90	4000	TRNSP	-	-	3100	■	GWS3122AT940	✓
25	II	✓	90	3000	TRNSP	-	-	2900	■	GWS3122AT930	✓
25	II	✓	80	5700	TRNSP	-	-	3900	■	GWS3122AT857	✓
25	II	✓	80	4000	TRNSP	-	-	3900	■	GWS3122AT840	✓
25	II	✓	80	3000	TRNSP	-	-	3700	■	GWS3122AT830	✓
Power LED dimmable DALI - 220-240 V 50/60 Hz											
26	II	✓	90	5700	TRNSP	-	-	3100	■	GWS3121AT957	✓
26	II	✓	90	4000	TRNSP	-	-	3100	■	GWS3121AT940	✓
26	II	✓	90	3000	TRNSP	-	-	2900	■	GWS3121AT930	✓
26	II	✓	80	5700	TRNSP	-	-	3900	■	GWS3121AT857	✓
26	II	✓	80	4000	TRNSP	-	-	3900	■	GWS3121AT840	✓
26	II	✓	80	3000	TRNSP	-	-	3700	■	GWS3121AT830	✓
Power LED dimmable DALI 220-240 V 50/60 Hz - through-wiring											
26	II	✓	90	5700	TRNSP	-	-	3100	■	GWS3123AT957	✓
26	II	✓	90	4000	TRNSP	-	-	3100	■	GWS3123AT940	✓
26	II	✓	90	3000	TRNSP	-	-	2900	■	GWS3123AT930	✓
26	II	✓	80	5700	TRNSP	-	-	3900	■	GWS3123AT857	✓
26	II	✓	80	4000	TRNSP	-	-	3900	■	GWS3123AT840	✓
26	II	✓	80	3000	TRNSP	-	-	3700	■	GWS3123AT830	✓

SMART [3] PLUS 1200 OPAL

IP66/69 - IK08 - 850 °C

LUMINAIRE WATTAGE (W)	CLASS	ENEC	CRI	KELVIN	OPTIC	BEAM ANGLE	LIGHTSOURCE LUMEN OUTPUT (lm)	LUMINAIRE LUMEN OUTPUT (lm)	COLOUR / FINISH	PART NUMBER	UKCA
Power LED 220-240 V 50/60 Hz											
36	II	✓	90	5700	OPAL	-	-	4200	■	GWS3220AP957	✓
36	II	✓	90	4000	OPAL	-	-	4200	■	GWS3220AP940	✓
36	II	✓	90	3000	OPAL	-	-	4000	■	GWS3220AP930	✓
36	II	✓	80	5700	OPAL	-	-	5400	■	GWS3220AP857	✓
36	II	✓	80	4000	OPAL	-	-	5400	■	GWS3220AP840	✓
36	II	✓	80	3000	OPAL	-	-	5100	■	GWS3220AP830	✓
Power LED 220-240 V 50/60 Hz - through-wiring											
36	II	✓	90	5700	OPAL	-	-	4200	■	GWS3222AP957	✓
36	II	✓	90	4000	OPAL	-	-	4200	■	GWS3222AP940	✓
36	II	✓	90	3000	OPAL	-	-	4000	■	GWS3222AP930	✓
36	II	✓	80	5700	OPAL	-	-	5400	■	GWS3222AP857	✓
36	II	✓	80	4000	OPAL	-	-	5400	■	GWS3222AP840	✓
36	II	✓	80	3000	OPAL	-	-	5100	■	GWS3222AP830	✓
Power LED dimmable DALI - 220-240 V 50/60 Hz											
38	II	✓	90	5700	OPAL	-	-	4200	■	GWS3221AP957	✓
38	II	✓	90	4000	OPAL	-	-	4200	■	GWS3221AP940	✓
38	II	✓	90	3000	OPAL	-	-	4000	■	GWS3221AP930	✓
38	II	✓	80	5700	OPAL	-	-	5400	■	GWS3221AP857	✓
38	II	✓	80	4000	OPAL	-	-	5400	■	GWS3221AP840	✓
38	II	✓	80	3000	OPAL	-	-	5100	■	GWS3221AP830	✓
Power LED dimmable DALI 220-240 V 50/60 Hz - through-wiring											
38	II	✓	90	5700	OPAL	-	-	4200	■	GWS3223AP957	✓
38	II	✓	90	4000	OPAL	-	-	4200	■	GWS3223AP940	✓
38	II	✓	90	3000	OPAL	-	-	4000	■	GWS3223AP930	✓
38	II	✓	80	5700	OPAL	-	-	5400	■	GWS3223AP857	✓
38	II	✓	80	4000	OPAL	-	-	5400	■	GWS3223AP840	✓
38	II	✓	80	3000	OPAL	-	-	5100	■	GWS3223AP830	✓



SMART [3] PLUS 1200 OPAL - EM

IP65 - IK08 - 850 °C

LUMINAIRE WATTAGE (W)	CLASS	ENEC	CRI	KELVIN	OPTIC	BEAM ANGLE	LIGHTSOURCE LUMEN OUTPUT (lm)	LUMINAIRE LUMEN OUTPUT (lm)	COLOUR / FINISH	PART NUMBER	UKCA
Power LED - dimmable DALI 220-240 V 50/60 Hz - emergency 3h											
38	II	-	90	5700	OPAL	-	-	4200	■	GWS3225AP957	✓
38	II	-	90	4000	OPAL	-	-	4200	■	GWS3225AP940	✓
38	II	-	90	3000	OPAL	-	-	4000	■	GWS3225AP930	✓
38	II	-	80	5700	OPAL	-	-	5400	■	GWS3225AP857	✓
38	II	-	80	4000	OPAL	-	-	5400	■	GWS3225AP840	✓
38	II	-	80	3000	OPAL	-	-	5100	■	GWS3225AP830	✓



SMART [3] PLUS 1200 TRANSPARENT

IP66/69 - IK08 - 850 °C



LUMINAIRE WATTAGE (W)	CLASS	ENEC	CRI	KELVIN	OPTIC	BEAM ANGLE	LIGHTSOURCE LUMEN OUTPUT (lm)	LUMINAIRE LUMEN OUTPUT (lm)	COLOUR / FINISH	PART NUMBER	UKCA
Power LED 220-240 V 50/60 Hz											
36	II	✓	90	5700	TRNSP	-	-	4500	■	GWS3220AT957	✓
36	II	✓	90	4000	TRNSP	-	-	4500	■	GWS3220AT940	✓
36	II	✓	90	3000	TRNSP	-	-	4200	■	GWS3220AT930	✓
36	II	✓	80	5700	TRNSP	-	-	5700	■	GWS3220AT857	✓
36	II	✓	80	4000	TRNSP	-	-	5700	■	GWS3220AT840	✓
36	II	✓	80	3000	TRNSP	-	-	5400	■	GWS3220AT830	✓
Power LED 220-240 V 50/60 Hz - through-wiring											
36	II	✓	90	5700	TRNSP	-	-	4500	■	GWS3222AT957	✓
36	II	✓	90	4000	TRNSP	-	-	4500	■	GWS3222AT940	✓
36	II	✓	90	3000	TRNSP	-	-	4200	■	GWS3222AT930	✓
36	II	✓	80	5700	TRNSP	-	-	5700	■	GWS3222AT857	✓
36	II	✓	80	4000	TRNSP	-	-	5700	■	GWS3222AT840	✓
36	II	✓	80	3000	TRNSP	-	-	5400	■	GWS3222AT830	✓
Power LED dimmable DALI - 220-240 V 50/60 Hz											
38	II	✓	90	5700	TRNSP	-	-	4500	■	GWS3221AT957	✓
38	II	✓	90	4000	TRNSP	-	-	4500	■	GWS3221AT940	✓
38	II	✓	90	3000	TRNSP	-	-	4200	■	GWS3221AT930	✓
38	II	✓	80	5700	TRNSP	-	-	5700	■	GWS3221AT857	✓
38	II	✓	80	4000	TRNSP	-	-	5700	■	GWS3221AT840	✓
38	II	✓	80	3000	TRNSP	-	-	5400	■	GWS3221AT830	✓
Power LED dimmable DALI 220-240 V 50/60 Hz - through-wiring											
38	II	✓	90	5700	TRNSP	-	-	4500	■	GWS3223AT957	✓
38	II	✓	90	4000	TRNSP	-	-	4500	■	GWS3223AT940	✓
38	II	✓	90	3000	TRNSP	-	-	4200	■	GWS3223AT930	✓
38	II	✓	80	5700	TRNSP	-	-	5700	■	GWS3223AT857	✓
38	II	✓	80	4000	TRNSP	-	-	5700	■	GWS3223AT840	✓
38	II	✓	80	3000	TRNSP	-	-	5400	■	GWS3223AT830	✓

SMART [3] PLUS 1200 TRANSPARENT - EM

IP65 - IK08 - 850 °C



LUMINAIRE WATTAGE (W)	CLASS	ENEC	CRI	KELVIN	OPTIC	BEAM ANGLE	LIGHTSOURCE LUMEN OUTPUT (lm)	LUMINAIRE LUMEN OUTPUT (lm)	COLOUR / FINISH	PART NUMBER	UKCA
Power LED - dimmable DALI 220-240 V 50/60 Hz - emergency 3h											
38	II	-	90	5700	TRNSP	-	-	4500	■	GWS3225AT957	✓
38	II	-	90	4000	TRNSP	-	-	4500	■	GWS3225AT940	✓
38	II	-	90	3000	TRNSP	-	-	4200	■	GWS3225AT930	✓
38	II	-	80	5700	TRNSP	-	-	5700	■	GWS3225AT857	✓
38	II	-	80	4000	TRNSP	-	-	5700	■	GWS3225AT840	✓
38	II	-	80	3000	TRNSP	-	-	5400	■	GWS3225AT830	✓

SMART [3] PLUS 1600 OPAL

IP66/69 - IK08 - 850 °C

LUMINAIRE WATTAGE (W)	CLASS	ENEC	CRI	KELVIN	OPTIC	BEAM ANGLE	LIGHTSOURCE LUMEN OUTPUT (lm)	LUMINAIRE LUMEN OUTPUT (lm)	COLOUR / FINISH	PART NUMBER	UKCA
-----------------------	-------	------	-----	--------	-------	------------	-------------------------------	-----------------------------	-----------------	-------------	------

Power LED 220-240 V 50/60 Hz

46	II	✓	90	5700	OPAL	-	-	5600	■	GWS3320AP957	✓
46	II	✓	90	4000	OPAL	-	-	5600	■	GWS3320AP940	✓
46	II	✓	90	3000	OPAL	-	-	5300	■	GWS3320AP930	✓
46	II	✓	80	5700	OPAL	-	-	7100	■	GWS3320AP857	✓
46	II	✓	80	4000	OPAL	-	-	7100	■	GWS3320AP840	✓
46	II	✓	80	3000	OPAL	-	-	6800	■	GWS3320AP830	✓

Power LED 220-240 V 50/60 Hz - through-wiring

46	II	✓	90	5700	OPAL	-	-	5600	■	GWS3322AP957	✓
46	II	✓	90	4000	OPAL	-	-	5600	■	GWS3322AP940	✓
46	II	✓	90	3000	OPAL	-	-	5300	■	GWS3322AP930	✓
46	II	✓	80	5700	OPAL	-	-	7100	■	GWS3322AP857	✓
46	II	✓	80	4000	OPAL	-	-	7100	■	GWS3322AP840	✓
46	II	✓	80	3000	OPAL	-	-	6800	■	GWS3322AP830	✓

Power LED dimmable DALI - 220-240 V 50/60 Hz

50	II	✓	90	5700	OPAL	-	-	5600	■	GWS3321AP957	✓
50	II	✓	90	4000	OPAL	-	-	5600	■	GWS3321AP940	✓
50	II	✓	90	3000	OPAL	-	-	5300	■	GWS3321AP930	✓
50	II	✓	80	5700	OPAL	-	-	7100	■	GWS3321AP857	✓
50	II	✓	80	4000	OPAL	-	-	7100	■	GWS3321AP840	✓
50	II	✓	80	3000	OPAL	-	-	6800	■	GWS3321AP830	✓

Power LED dimmable DALI 220-240 V 50/60 Hz - through-wiring

50	II	✓	90	5700	OPAL	-	-	5600	■	GWS3323AP957	✓
50	II	✓	90	4000	OPAL	-	-	5600	■	GWS3323AP940	✓
50	II	✓	90	3000	OPAL	-	-	5300	■	GWS3323AP930	✓
50	II	✓	80	5700	OPAL	-	-	7100	■	GWS3323AP857	✓
50	II	✓	80	4000	OPAL	-	-	7100	■	GWS3323AP840	✓
50	II	✓	80	3000	OPAL	-	-	6800	■	GWS3323AP830	✓



SMART [3] PLUS 1600 OPAL - EM

IP65 - IK08 - 850 °C

LUMINAIRE WATTAGE (W)	CLASS	ENEC	CRI	KELVIN	OPTIC	BEAM ANGLE	LIGHTSOURCE LUMEN OUTPUT (lm)	LUMINAIRE LUMEN OUTPUT (lm)	COLOUR / FINISH	PART NUMBER	UKCA
-----------------------	-------	------	-----	--------	-------	------------	-------------------------------	-----------------------------	-----------------	-------------	------

Power LED - dimmable DALI 220-240 V 50/60 Hz - emergency 3h

50	II	-	90	5700	OPAL	-	-	5600	■	GWS3325AP957	✓
50	II	-	90	4000	OPAL	-	-	5600	■	GWS3325AP940	✓
50	II	-	90	3000	OPAL	-	-	5300	■	GWS3325AP930	✓
50	II	-	80	5700	OPAL	-	-	7100	■	GWS3325AP857	✓
50	II	-	80	4000	OPAL	-	-	7100	■	GWS3325AP840	✓
50	II	-	80	3000	OPAL	-	-	6800	■	GWS3325AP830	✓



SMART [3] PLUS 1600 TRANSPARENT

IP66/69 - IK08 - 850 °C



LUMINAIRE WATTAGE [W]	CLASS	ENEC	CRI	KELVIN	OPTIC	BEAM ANGLE	LIGHTSOURCE LUMEN OUTPUT (lm)	LUMINAIRE LUMEN OUTPUT (lm)	COLOUR / FINISH	PART NUMBER	UKCA
Power LED 220-240 V 50/60 Hz											
46	II	✓	90	5700	TRNSP	-	-	5900	■	GWS3320AT957	✓
46	II	✓	90	4000	TRNSP	-	-	5900	■	GWS3320AT940	✓
46	II	✓	90	3000	TRNSP	-	-	5500	■	GWS3320AT930	✓
46	II	✓	80	5700	TRNSP	-	-	7500	■	GWS3320AT857	✓
46	II	✓	80	4000	TRNSP	-	-	7500	■	GWS3320AT840	✓
46	II	✓	80	3000	TRNSP	-	-	7100	■	GWS3320AT830	✓
Power LED 220-240 V 50/60 Hz - through-wiring											
46	II	✓	90	5700	TRNSP	-	-	5900	■	GWS3322AT957	✓
46	II	✓	90	4000	TRNSP	-	-	5900	■	GWS3322AT940	✓
46	II	✓	90	3000	TRNSP	-	-	5500	■	GWS3322AT930	✓
46	II	✓	80	5700	TRNSP	-	-	7500	■	GWS3322AT857	✓
46	II	✓	80	4000	TRNSP	-	-	7500	■	GWS3322AT840	✓
46	II	✓	80	3000	TRNSP	-	-	7100	■	GWS3322AT830	✓
Power LED dimmable DALI - 220-240 V 50/60 Hz											
50	II	✓	90	5700	TRNSP	-	-	5900	■	GWS3321AT957	✓
50	II	✓	90	4000	TRNSP	-	-	5900	■	GWS3321AT940	✓
50	II	✓	90	3000	TRNSP	-	-	5500	■	GWS3321AT930	✓
50	II	✓	80	5700	TRNSP	-	-	7500	■	GWS3321AT857	✓
50	II	✓	80	4000	TRNSP	-	-	7500	■	GWS3321AT840	✓
50	II	✓	80	3000	TRNSP	-	-	7100	■	GWS3321AT830	✓
Power LED dimmable DALI 220-240 V 50/60 Hz - through-wiring											
50	II	✓	90	5700	TRNSP	-	-	5900	■	GWS3323AT957	✓
50	II	✓	90	4000	TRNSP	-	-	5900	■	GWS3323AT940	✓
50	II	✓	90	3000	TRNSP	-	-	5500	■	GWS3323AT930	✓
50	II	✓	80	5700	TRNSP	-	-	7500	■	GWS3323AT857	✓
50	II	✓	80	4000	TRNSP	-	-	7500	■	GWS3323AT840	✓
50	II	✓	80	3000	TRNSP	-	-	7100	■	GWS3323AT830	✓

SMART [3] PLUS 1600 TRANSPARENT - EM

IP65 - IK08 - 850 °C



LUMINAIRE WATTAGE [W]	CLASS	ENEC	CRI	KELVIN	OPTIC	BEAM ANGLE	LIGHTSOURCE LUMEN OUTPUT (lm)	LUMINAIRE LUMEN OUTPUT (lm)	COLOUR / FINISH	PART NUMBER	UKCA
Power LED - dimmable DALI 220-240 V 50/60 Hz - emergency 3h											
50	II	-	90	5700	TRNSP	-	-	5900	■	GWS3325AT957	✓
50	II	-	90	4000	TRNSP	-	-	5900	■	GWS3325AT940	✓
50	II	-	90	3000	TRNSP	-	-	5500	■	GWS3325AT930	✓
50	II	-	80	5700	TRNSP	-	-	7500	■	GWS3325AT857	✓
50	II	-	80	4000	TRNSP	-	-	7500	■	GWS3325AT840	✓
50	II	-	80	3000	TRNSP	-	-	7100	■	GWS3325AT830	✓

SMART [3] PLUS 1600 MEDIUM BEAM

IP66/69 - IK08 - 850 °C

LUMINAIRE WATTAGE (W)	CLASS	ENEC	CRI	KELVIN	OPTIC	BEAM ANGLE	LIGHTSOURCE LUMEN OUTPUT (lm)	LUMINAIRE LUMEN OUTPUT (lm)	COLOUR / FINISH	PART NUMBER	UKCA
Power LED 220-240 V 50/60 Hz											
46	II	✓	90	5700	SYMM	-	-	5600	■	GWS3320AC957	✓
46	II	✓	90	4000	SYMM	-	-	5600	■	GWS3320AC940	✓
46	II	✓	90	3000	SYMM	-	-	5200	■	GWS3320AC930	✓
46	II	✓	80	5700	SYMM	-	-	7100	■	GWS3320AC857	✓
46	II	✓	80	4000	SYMM	-	-	7100	■	GWS3320AC840	✓
46	II	✓	80	3000	SYMM	-	-	6700	■	GWS3320AC830	✓

Power LED 220-240 V 50/60 Hz - through-wiring

46	II	✓	90	5700	SYMM	-	-	5600	■	GWS3322AC957	✓
46	II	✓	90	4000	SYMM	-	-	5600	■	GWS3322AC940	✓
46	II	✓	90	3000	SYMM	-	-	5200	■	GWS3322AC930	✓
46	II	✓	80	5700	SYMM	-	-	7100	■	GWS3322AC857	✓
46	II	✓	80	4000	SYMM	-	-	7100	■	GWS3322AC840	✓
46	II	✓	80	3000	SYMM	-	-	6700	■	GWS3322AC830	✓

Power LED dimmable DALI - 220-240 V 50/60 Hz

50	II	✓	90	5700	SYMM	-	-	5600	■	GWS3321AC957	✓
50	II	✓	90	4000	SYMM	-	-	5600	■	GWS3321AC940	✓
50	II	✓	90	3000	SYMM	-	-	5200	■	GWS3321AC930	✓
50	II	✓	80	5700	SYMM	-	-	7100	■	GWS3321AC857	✓
50	II	✓	80	4000	SYMM	-	-	7100	■	GWS3321AC840	✓
50	II	✓	80	3000	SYMM	-	-	6700	■	GWS3321AC830	✓

Power LED dimmable DALI 220-240 V 50/60 Hz - through-wiring

50	II	✓	90	5700	SYMM	-	-	5600	■	GWS3323AC957	✓
50	II	✓	90	4000	SYMM	-	-	5600	■	GWS3323AC940	✓
50	II	✓	90	3000	SYMM	-	-	5200	■	GWS3323AC930	✓
50	II	✓	80	5700	SYMM	-	-	7100	■	GWS3323AC857	✓
50	II	✓	80	4000	SYMM	-	-	7100	■	GWS3323AC840	✓
50	II	✓	80	3000	SYMM	-	-	6700	■	GWS3323AC830	✓



SMART [3] PLUS 1600 PARKING

IP66/69 - IK08 - 850 °C

LUMINAIRE WATTAGE (W)	CLASS	ENEC	CRI	KELVIN	OPTIC	BEAM ANGLE	LIGHTSOURCE LUMEN OUTPUT (lm)	LUMINAIRE LUMEN OUTPUT (lm)	COLOUR / FINISH	PART NUMBER	UKCA
Power LED 220-240 V 50/60 Hz											
46	II	✓	80	5700	ELL	-	-	6600	■	GWS3320AB857	✓
46	II	✓	80	4000	ELL	-	-	6600	■	GWS3320AB840	✓
46	II	✓	80	3000	ELL	-	-	6200	■	GWS3320AB830	✓

Power LED 220-240 V 50/60 Hz - through-wiring

46	II	✓	80	5700	ELL	-	-	6600	■	GWS3322AB857	✓
46	II	✓	80	4000	ELL	-	-	6600	■	GWS3322AB840	✓
46	II	✓	80	3000	ELL	-	-	6200	■	GWS3322AB830	✓

Power LED dimmable DALI - 220-240 V 50/60 Hz

50	II	✓	80	5700	ELL	-	-	6600	■	GWS3321AB857	✓
50	II	✓	80	4000	ELL	-	-	6600	■	GWS3321AB840	✓
50	II	✓	80	3000	ELL	-	-	6200	■	GWS3321AB830	✓

Power LED dimmable DALI 220-240 V 50/60 Hz - through-wiring

50	II	✓	80	5700	ELL	-	-	6600	■	GWS3323AB857	✓
50	II	✓	80	4000	ELL	-	-	6600	■	GWS3323AB840	✓
50	II	✓	80	3000	ELL	-	-	6200	■	GWS3323AB830	✓



SMART [3] PLUS 1600 PARKING - EM

IP65 - IK08 - 850 °C

LUMINAIRE WATTAGE (W)	CLASS	ENEC	CRI	KELVIN	OPTIC	BEAM ANGLE	LIGHTSOURCE LUMEN OUTPUT (lm)	LUMINAIRE LUMEN OUTPUT (lm)	COLOUR / FINISH	PART NUMBER	UKCA
Power LED - dimmable DALI 220-240 V 50/60 Hz - emergency 3h											
50	II	-	80	5700	ELL	-	-	6600	■	GWS3325AB857	✓
50	II	-	80	4000	ELL	-	-	6600	■	GWS3325AB840	✓



SMART [3] PLUS 1600 HLO OPAL

IP66/69 - IK08 - 850 °C



LUMINAIRE WATTAGE [W]	CLASS	ENEC	CRI	KELVIN	OPTIC	BEAM ANGLE	LIGHTSOURCE LUMEN OUTPUT (lm)	LUMINAIRE LUMEN OUTPUT (lm)	COLOUR / FINISH	PART NUMBER	UKCA
Power LED 220-240 V 50/60 Hz											
61	II	✓	90	5700	OPAL	-	-	7100	■	GWS3320BP957	✓
61	II	✓	90	4000	OPAL	-	-	7100	■	GWS3320BP940	✓
61	II	✓	90	3000	OPAL	-	-	6600	■	GWS3320BP930	✓
61	II	✓	80	5700	OPAL	-	-	9000	■	GWS3320BP857	✓
61	II	✓	80	4000	OPAL	-	-	9000	■	GWS3320BP840	✓
61	II	✓	80	3000	OPAL	-	-	8500	■	GWS3320BP830	✓
Power LED 220-240 V 50/60 Hz - through-wiring											
61	II	✓	90	5700	OPAL	-	-	7100	■	GWS3322BP957	✓
61	II	✓	90	4000	OPAL	-	-	7100	■	GWS3322BP940	✓
61	II	✓	90	3000	OPAL	-	-	6600	■	GWS3322BP930	✓
61	II	✓	80	5700	OPAL	-	-	9000	■	GWS3322BP857	✓
61	II	✓	80	4000	OPAL	-	-	9000	■	GWS3322BP840	✓
61	II	✓	80	3000	OPAL	-	-	8500	■	GWS3322BP830	✓
Power LED dimmable DALI - 220-240 V 50/60 Hz											
63	II	✓	90	5700	OPAL	-	-	7100	■	GWS3321BP957	✓
63	II	✓	90	4000	OPAL	-	-	7100	■	GWS3321BP940	✓
63	II	✓	90	3000	OPAL	-	-	6600	■	GWS3321BP930	✓
63	II	✓	80	5700	OPAL	-	-	9000	■	GWS3321BP857	✓
63	II	✓	80	4000	OPAL	-	-	9000	■	GWS3321BP840	✓
63	II	✓	80	3000	OPAL	-	-	8500	■	GWS3321BP830	✓
Power LED dimmable DALI 220-240 V 50/60 Hz - through-wiring											
63	II	✓	90	5700	OPAL	-	-	7100	■	GWS3323BP957	✓
63	II	✓	90	4000	OPAL	-	-	7100	■	GWS3323BP940	✓
63	II	✓	90	3000	OPAL	-	-	6600	■	GWS3323BP930	✓
63	II	✓	80	5700	OPAL	-	-	9000	■	GWS3323BP857	✓
63	II	✓	80	4000	OPAL	-	-	9000	■	GWS3323BP840	✓
63	II	✓	80	3000	OPAL	-	-	8500	■	GWS3323BP830	✓

SMART [3] PLUS 1600 HLO OPAL - EM

IP65 - IK08 - 850 °C



LUMINAIRE WATTAGE [W]	CLASS	ENEC	CRI	KELVIN	OPTIC	BEAM ANGLE	LIGHTSOURCE LUMEN OUTPUT (lm)	LUMINAIRE LUMEN OUTPUT (lm)	COLOUR / FINISH	PART NUMBER	UKCA
Power LED - dimmable DALI 220-240 V 50/60 Hz - emergency 3h											
63	II	-	90	5700	OPAL	-	-	7100	■	GWS3325BP957	✓
63	II	-	90	4000	OPAL	-	-	7100	■	GWS3325BP940	✓
63	II	-	90	3000	OPAL	-	-	6600	■	GWS3325BP930	✓
63	II	-	80	5700	OPAL	-	-	9000	■	GWS3325BP857	✓
63	II	-	80	4000	OPAL	-	-	9000	■	GWS3325BP840	✓
63	II	-	80	3000	OPAL	-	-	8500	■	GWS3325BP830	✓

SMART [3] PLUS 1600 HLO TRANSPARENT

IP66/69 - IK08 - 850 °C

LUMINAIRE WATTAGE (W)	CLASS	ENEC	CRI	KELVIN	OPTIC	BEAM ANGLE	LIGHTSOURCE LUMEN OUTPUT (lm)	LUMINAIRE LUMEN OUTPUT (lm)	COLOUR / FINISH	PART NUMBER	UKCA
Power LED 220-240 V 50/60 Hz											
61	II	✓	90	5700	TRNSP	-	-	7400	■	GWS3320BT957	✓
61	II	✓	90	4000	TRNSP	-	-	7400	■	GWS3320BT940	✓
61	II	✓	90	3000	TRNSP	-	-	6900	■	GWS3320BT930	✓
61	II	✓	80	5700	TRNSP	-	-	9400	■	GWS3320BT857	✓
61	II	✓	80	4000	TRNSP	-	-	9400	■	GWS3320BT840	✓
61	II	✓	80	3000	TRNSP	-	-	8900	■	GWS3320BT830	✓
Power LED 220-240 V 50/60 Hz - through-wiring											
61	II	✓	90	5700	TRNSP	-	-	7400	■	GWS3322BT957	✓
61	II	✓	90	4000	TRNSP	-	-	7400	■	GWS3322BT940	✓
61	II	✓	90	3000	TRNSP	-	-	6900	■	GWS3322BT930	✓
61	II	✓	80	5700	TRNSP	-	-	9400	■	GWS3322BT857	✓
61	II	✓	80	4000	TRNSP	-	-	9400	■	GWS3322BT840	✓
61	II	✓	80	3000	TRNSP	-	-	8900	■	GWS3322BT830	✓
Power LED dimmable DALI - 220-240 V 50/60 Hz											
63	II	✓	90	5700	TRNSP	-	-	7400	■	GWS3321BT957	✓
63	II	✓	90	4000	TRNSP	-	-	7400	■	GWS3321BT940	✓
63	II	✓	90	3000	TRNSP	-	-	6900	■	GWS3321BT930	✓
63	II	✓	80	5700	TRNSP	-	-	9400	■	GWS3321BT857	✓
63	II	✓	80	4000	TRNSP	-	-	9400	■	GWS3321BT840	✓
63	II	✓	80	3000	TRNSP	-	-	8900	■	GWS3321BT830	✓
Power LED dimmable DALI 220-240 V 50/60 Hz - through-wiring											
63	II	✓	90	5700	TRNSP	-	-	7400	■	GWS3323BT957	✓
63	II	✓	90	4000	TRNSP	-	-	7400	■	GWS3323BT940	✓
63	II	✓	90	3000	TRNSP	-	-	6900	■	GWS3323BT930	✓
63	II	✓	80	5700	TRNSP	-	-	9400	■	GWS3323BT857	✓
63	II	✓	80	4000	TRNSP	-	-	9400	■	GWS3323BT840	✓
63	II	✓	80	3000	TRNSP	-	-	8900	■	GWS3323BT830	✓



SMART [3] PLUS 1600 HLO TRANSPARENT - EM

IP65 - IK08 - 850 °C

LUMINAIRE WATTAGE (W)	CLASS	ENEC	CRI	KELVIN	OPTIC	BEAM ANGLE	LIGHTSOURCE LUMEN OUTPUT (lm)	LUMINAIRE LUMEN OUTPUT (lm)	COLOUR / FINISH	PART NUMBER	UKCA
Power LED - dimmable DALI 220-240 V 50/60 Hz - emergency 3h											
63	II	-	90	5700	TRNSP	-	-	7400	■	GWS3325BT957	✓
63	II	-	90	4000	TRNSP	-	-	7400	■	GWS3325BT940	✓
63	II	-	90	3000	TRNSP	-	-	6900	■	GWS3325BT930	✓
63	II	-	80	5700	TRNSP	-	-	9400	■	GWS3325BT857	✓
63	II	-	80	4000	TRNSP	-	-	9400	■	GWS3325BT840	✓
63	II	-	80	3000	TRNSP	-	-	8900	■	GWS3325BT830	✓



SMART [3] PLUS 1600 HLO MEDIUM BEAM

IP66/69 - IK08 - 850 °C



LUMINAIRE WATTAGE (W)	CLASS	ENEC	CRI	KELVIN	OPTIC	BEAM ANGLE	LIGHTSOURCE LUMEN OUTPUT (lm)	LUMINAIRE LUMEN OUTPUT (lm)	COLOUR / FINISH	PART NUMBER	UKCA
Power LED 220-240 V 50/60 Hz											
61	II	✓	90	5700	SYMM	-	-	7100	■	GWS3320BC957	✓
61	II	✓	90	4000	SYMM	-	-	7100	■	GWS3320BC940	✓
61	II	✓	90	3000	SYMM	-	-	6600	■	GWS3320BC930	✓
61	II	✓	80	5700	SYMM	-	-	8900	■	GWS3320BC857	✓
61	II	✓	80	4000	SYMM	-	-	8900	■	GWS3320BC840	✓
61	II	✓	80	3000	SYMM	-	-	8500	■	GWS3320BC830	✓
Power LED 220-240 V 50/60 Hz - through-wiring											
61	II	✓	90	5700	SYMM	-	-	7100	■	GWS3322BC957	✓
61	II	✓	90	4000	SYMM	-	-	7100	■	GWS3322BC940	✓
61	II	✓	90	3000	SYMM	-	-	6600	■	GWS3322BC930	✓
61	II	✓	80	5700	SYMM	-	-	8900	■	GWS3322BC857	✓
61	II	✓	80	4000	SYMM	-	-	8900	■	GWS3322BC840	✓
61	II	✓	80	3000	SYMM	-	-	8500	■	GWS3322BC830	✓
Power LED dimmable DALI - 220-240 V 50/60 Hz											
63	II	✓	90	5700	SYMM	-	-	7100	■	GWS3321BC957	✓
63	II	✓	90	4000	SYMM	-	-	7100	■	GWS3321BC940	✓
63	II	✓	90	3000	SYMM	-	-	6600	■	GWS3321BC930	✓
63	II	✓	80	5700	SYMM	-	-	8900	■	GWS3321BC857	✓
63	II	✓	80	4000	SYMM	-	-	8900	■	GWS3321BC840	✓
63	II	✓	80	3000	SYMM	-	-	8500	■	GWS3321BC830	✓
Power LED dimmable DALI 220-240 V 50/60 Hz - through-wiring											
63	II	✓	90	5700	SYMM	-	-	7100	■	GWS3323BC957	✓
63	II	✓	90	4000	SYMM	-	-	7100	■	GWS3323BC940	✓
63	II	✓	90	3000	SYMM	-	-	6600	■	GWS3323BC930	✓
63	II	✓	80	5700	SYMM	-	-	8900	■	GWS3323BC857	✓
63	II	✓	80	4000	SYMM	-	-	8900	■	GWS3323BC840	✓
63	II	✓	80	3000	SYMM	-	-	8500	■	GWS3323BC830	✓

SMART [3] PLUS 1600 HLO PARKING

IP66/69 - IK08 - 850 °C



LUMINAIRE WATTAGE (W)	CLASS	ENEC	CRI	KELVIN	OPTIC	BEAM ANGLE	LIGHTSOURCE LUMEN OUTPUT (lm)	LUMINAIRE LUMEN OUTPUT (lm)	COLOUR / FINISH	PART NUMBER	UKCA
Power LED 220-240 V 50/60 Hz											
61	II	✓	80	5700	ELL	-	-	8200	■	GWS3320BB857	✓
61	II	✓	80	4000	ELL	-	-	8200	■	GWS3320BB840	✓
61	II	✓	80	3000	ELL	-	-	7800	■	GWS3320BB830	✓
Power LED 220-240 V 50/60 Hz - through-wiring											
61	II	✓	80	5700	ELL	-	-	8200	■	GWS3322BB857	✓
61	II	✓	80	4000	ELL	-	-	8200	■	GWS3322BB840	✓
61	II	✓	80	3000	ELL	-	-	7800	■	GWS3322BB830	✓
Power LED dimmable DALI - 220-240 V 50/60 Hz											
63	II	✓	80	5700	ELL	-	-	8200	■	GWS3321BB857	✓
63	II	✓	80	4000	ELL	-	-	8200	■	GWS3321BB840	✓
63	II	✓	80	3000	ELL	-	-	7800	■	GWS3321BB830	✓
Power LED dimmable DALI 220-240 V 50/60 Hz - through-wiring											
63	II	✓	80	5700	ELL	-	-	8200	■	GWS3323BB857	✓
63	II	✓	80	4000	ELL	-	-	8200	■	GWS3323BB840	✓
63	II	✓	80	3000	ELL	-	-	7800	■	GWS3323BB830	✓

SMART [3] PLUS 1600 HLO PARKING - EM

IP65 - IK08 - 850 °C



LUMINAIRE WATTAGE (W)	CLASS	ENEC	CRI	KELVIN	OPTIC	BEAM ANGLE	LIGHTSOURCE LUMEN OUTPUT (lm)	LUMINAIRE LUMEN OUTPUT (lm)	COLOUR / FINISH	PART NUMBER	UKCA
Power LED - dimmable DALI 220-240 V 50/60 Hz - emergency 3h											
63	II	-	80	5700	ELL	-	-	8200	■	GWS3325BB857	✓
63	II	-	80	4000	ELL	-	-	8200	■	GWS3325BB840	✓

Optional accessories

DESCRIPTION	COLOR	PART NUMBER	UKCA
SMART [3] PLUS			
Wall-mounting bracket 30°/45°		GWS3191	✓
Rigid pipe adaptor		GWS3193	✓
Male connector 4 poles 10 A		GWS3194	✓
Continuous line connection kit		GWS3197	✓
Emergency kit 3h for through wiring version		GWS3198	✓
RINA clamp kit		GWS3296	✓



GWS3194

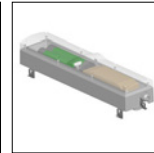

GWS3198



SMART [3]



Albinoleffe stadium - Zanica - Italy

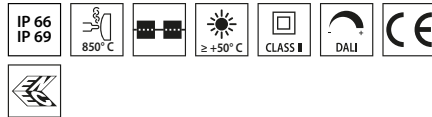

Scan the QR-code for the latest information

■ Grey RAL 7035 / Grey RAL7035 /

Watertight fixture IP66/69/69 for industrial applications, ideal for production areas, warehouses, and logistics areas

- Designed to replace fluorescent devices and lowbays up to 6,500 lm
- IK08 body in RAL7035 colored self-exhausting polycarbonate
- Available in 3 sizes: 800 mm, 1200 mm and 1600 mm
- Available in 3000K, 4000K and 5700K with CRI ≥80
- Available with powers ranging from 18W to 58W and flux ranging from 1,700lm to 6,500lm
- Mid-power LED with wire bonding
- Available with integrated On/Off or DALI driver
- The through wiring version has pre-wired mechanical and electrical connections, allowing up to 25 fixtures installed in a continuous row
- Available in 2 different optical solutions: transparent or opal diffuser in UV-stabilized, self-extinguishing polycarbonate
- The device can be hung or wall-mounted through bracket accessory with a tilt of 30° or 45° on the vertical axis
- External emergency kit with 3h autonomy compatible with through wiring versions available (to be ordered separately)

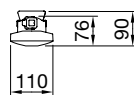
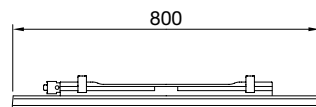

SMART [3]
800

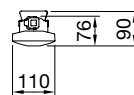
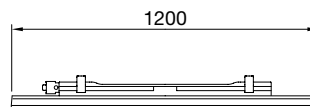

SMART [3]
1200

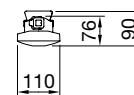
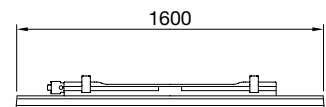

SMART [3]
1600

SMART [3] 800 OPAL

IP66/69 - IK08 - 850 °C



LUMINAIRE WATTAGE [W]	CLASS	ENEC	CRI	KELVIN	OPTIC	BEAM ANGLE	LIGHTSOURCE LUMEN OUTPUT [lm]	LUMINAIRE LUMEN OUTPUT [lm]	COLOUR / FINISH	PART NUMBER	UKCA
Power LED 220-240 V 50/60 Hz											
27	II	✓	80	5700	OPAL	-	-	3200	■	GWS3218P57K	✓
27	II	✓	80	4000	OPAL	-	-	3200	■	GWS3218P	✓
27	II	✓	80	3000	OPAL	-	-	3000	■	GWS3218P30K	✓
15	II	✓	80	4000	OPAL	-	-	1600	■	GWS3118P	✓
Power LED 220-240 V 50/60 Hz - through-wiring											
27	II	✓	80	5700	OPAL	-	-	3200	■	GWS3218PL57K	✓
27	II	✓	80	4000	OPAL	-	-	3200	■	GWS3218PL	✓
27	II	✓	80	3000	OPAL	-	-	3000	■	GWS3218PL30K	✓
15	II	✓	80	4000	OPAL	-	-	1600	■	GWS3118PL	✓
Power LED dimmable DALI - 220-240 V 50/60 Hz											
27	II	✓	80	5700	OPAL	-	-	3200	■	GWS3218PD57K	✓
27	II	✓	80	4000	OPAL	-	-	3200	■	GWS3218PD	✓
27	II	✓	80	3000	OPAL	-	-	3000	■	GWS3218PD30K	✓
15	II	✓	80	4000	OPAL	-	-	1600	■	GWS3118PD	✓
Power LED dimmable DALI 220-240 V 50/60 Hz - through-wiring											
27	II	✓	80	5700	OPAL	-	-	3200	■	GWS3218PLD57K	✓
27	II	✓	80	4000	OPAL	-	-	3200	■	GWS3218PLD	✓
27	II	✓	80	3000	OPAL	-	-	3000	■	GWS3218PLD30K	✓
15	II	✓	80	4000	OPAL	-	-	1600	■	GWS3118PLD	✓

SMART [3] 800 TRANSPARENT

IP66/69 - IK08 - 850 °C



LUMINAIRE WATTAGE [W]	CLASS	ENEC	CRI	KELVIN	OPTIC	BEAM ANGLE	LIGHTSOURCE LUMEN OUTPUT [lm]	LUMINAIRE LUMEN OUTPUT [lm]	COLOUR / FINISH	PART NUMBER	UKCA
Power LED 220-240 V 50/60 Hz											
27	II	✓	80	5700	TRNSP	-	-	3400	■	GWS3218T57K	✓
27	II	✓	80	4000	TRNSP	-	-	3400	■	GWS3218T	✓
27	II	✓	80	3000	TRNSP	-	-	3200	■	GWS3218T30K	✓
15	II	✓	80	4000	TRNSP	-	-	1700	■	GWS3118T	✓
Power LED 220-240 V 50/60 Hz - through-wiring											
27	II	✓	80	5700	TRNSP	-	-	3400	■	GWS3218TL57K	✓
27	II	✓	80	4000	TRNSP	-	-	3400	■	GWS3218TL	✓
27	II	✓	80	3000	TRNSP	-	-	3200	■	GWS3218TL30K	✓
15	II	✓	80	4000	TRNSP	-	-	1700	■	GWS3118TL	✓
Power LED dimmable DALI - 220-240 V 50/60 Hz											
27	II	✓	80	5700	TRNSP	-	-	3400	■	GWS3218TD57K	✓
27	II	✓	80	4000	TRNSP	-	-	3400	■	GWS3218TD	✓
27	II	✓	80	3000	TRNSP	-	-	3200	■	GWS3218TD30K	✓
15	II	✓	80	4000	TRNSP	-	-	1700	■	GWS3118TD	✓
Power LED dimmable DALI 220-240 V 50/60 Hz - through-wiring											
27	II	✓	80	5700	TRNSP	-	-	3400	■	GWS3218TLD57K	✓
27	II	✓	80	4000	TRNSP	-	-	3400	■	GWS3218TLD	✓
27	II	✓	80	3000	TRNSP	-	-	3200	■	GWS3218TLD30K	✓
15	II	✓	80	4000	TRNSP	-	-	1700	■	GWS3118TLD	✓

SMART [3] 1200 OPAL

IP66/69 - IK08 - 850 °C

LUMINAIRE WATTAGE [W]	CLASS	ENEC	CRI	KELVIN	OPTIC	BEAM ANGLE	LIGHTSOURCE LUMEN OUTPUT [lm]	LUMINAIRE LUMEN OUTPUT [lm]	COLOUR / FINISH	PART NUMBER	UKCA
Power LED 220-240 V 50/60 Hz											
40	II	✓	80	5700	OPAL	-	-	5000	■	GWS3236P57K	✓
40	II	✓	80	4000	OPAL	-	-	5000	■	GWS3236P	✓
40	II	✓	80	3000	OPAL	-	-	4800	■	GWS3236P30K	✓
20	II	✓	80	4000	OPAL	-	-	2500	■	GWS3136P	✓
Power LED 220-240 V 50/60 Hz - through-wiring											
40	II	✓	80	5700	OPAL	-	-	5000	■	GWS3236PL57K	✓
40	II	✓	80	4000	OPAL	-	-	5000	■	GWS3236PL	✓
40	II	✓	80	3000	OPAL	-	-	4800	■	GWS3236PL30K	✓
20	II	✓	80	4000	OPAL	-	-	2500	■	GWS3136PL	✓
Power LED dimmable DALI - 220-240 V 50/60 Hz											
40	II	✓	80	5700	OPAL	-	-	5000	■	GWS3236PD57K	✓
40	II	✓	80	4000	OPAL	-	-	5000	■	GWS3236PD	✓
40	II	✓	80	3000	OPAL	-	-	4800	■	GWS3236PD30K	✓
20	II	✓	80	4000	OPAL	-	-	2500	■	GWS3136PD	✓
Power LED dimmable DALI 220-240 V 50/60 Hz - through-wiring											
40	II	✓	80	5700	OPAL	-	-	5000	■	GWS3236PLD57K	✓
40	II	✓	80	4000	OPAL	-	-	5000	■	GWS3236PLD	✓
40	II	✓	80	3000	OPAL	-	-	4800	■	GWS3236PLD30K	✓
20	II	✓	80	4000	OPAL	-	-	2500	■	GWS3136PLD	✓



SMART [3] 1200 TRANSPARENT

IP66/69 - IK08 - 850 °C

LUMINAIRE WATTAGE [W]	CLASS	ENEC	CRI	KELVIN	OPTIC	BEAM ANGLE	LIGHTSOURCE LUMEN OUTPUT [lm]	LUMINAIRE LUMEN OUTPUT [lm]	COLOUR / FINISH	PART NUMBER	UKCA
Power LED 220-240 V 50/60 Hz											
40	II	✓	80	5700	TRNSP	-	-	5200	■	GWS3236T57K	✓
40	II	✓	80	4000	TRNSP	-	-	5200	■	GWS3236T	✓
40	II	✓	80	3000	TRNSP	-	-	4900	■	GWS3236T30K	✓
20	II	✓	80	4000	TRNSP	-	-	2600	■	GWS3136T	✓
Power LED 220-240 V 50/60 Hz - through-wiring											
40	II	✓	80	5700	TRNSP	-	-	5200	■	GWS3236TL57K	✓
40	II	✓	80	4000	TRNSP	-	-	5200	■	GWS3236TL	✓
40	II	✓	80	3000	TRNSP	-	-	4900	■	GWS3236TL30K	✓
20	II	✓	80	4000	TRNSP	-	-	2600	■	GWS3136TL	✓
Power LED dimmable DALI - 220-240 V 50/60 Hz											
40	II	✓	80	5700	TRNSP	-	-	5200	■	GWS3236TD57K	✓
40	II	✓	80	4000	TRNSP	-	-	5200	■	GWS3236TD	✓
40	II	✓	80	3000	TRNSP	-	-	4900	■	GWS3236TD30K	✓
20	II	✓	80	4000	TRNSP	-	-	2600	■	GWS3136TD	✓
Power LED dimmable DALI 220-240 V 50/60 Hz - through-wiring											
40	II	✓	80	5700	TRNSP	-	-	5200	■	GWS3236TLD57K	✓
40	II	✓	80	4000	TRNSP	-	-	5200	■	GWS3236TLD	✓
40	II	✓	80	3000	TRNSP	-	-	4900	■	GWS3236TLD30K	✓
20	II	✓	80	4000	TRNSP	-	-	2600	■	GWS3136TLD	✓



SMART [3] 1600 OPAL

IP66/69 - IK08 - 850 °C



LUMINAIRE WATTAGE [W]	CLASS	ENEC	CRI	KELVIN	OPTIC	BEAM ANGLE	LIGHTSOURCE LUMEN OUTPUT [lm]	LUMINAIRE LUMEN OUTPUT [lm]	COLOUR / FINISH	PART NUMBER	UKCA
Power LED 220-240 V 50/60 Hz											
50	II	✓	80	5700	OPAL	-	-	6400	■	GWS3258P57K	✓
50	II	✓	80	4000	OPAL	-	-	6400	■	GWS3258P	✓
50	II	✓	80	3000	OPAL	-	-	6100	■	GWS3258P30K	✓
26	II	✓	80	4000	OPAL	-	-	3250	■	GWS3158P	✓
Power LED 220-240 V 50/60 Hz - through-wiring											
50	II	✓	80	5700	OPAL	-	-	6400	■	GWS3258PL57K	✓
50	II	✓	80	4000	OPAL	-	-	6400	■	GWS3258PL	✓
50	II	✓	80	3000	OPAL	-	-	6100	■	GWS3258PL30K	✓
26	II	✓	80	4000	OPAL	-	-	3250	■	GWS3158PL	✓
Power LED dimmable DALI - 220-240 V 50/60 Hz											
50	II	✓	80	5700	OPAL	-	-	6400	■	GWS3258PD57K	✓
50	II	✓	80	4000	OPAL	-	-	6400	■	GWS3258PD	✓
50	II	✓	80	3000	OPAL	-	-	6100	■	GWS3258PD30K	✓
26	II	✓	80	4000	OPAL	-	-	3250	■	GWS3158PD	✓
Power LED dimmable DALI 220-240 V 50/60 Hz - through-wiring											
50	II	✓	80	5700	OPAL	-	-	6400	■	GWS3258PLD57K	✓
50	II	✓	80	4000	OPAL	-	-	6400	■	GWS3258PLD	✓
50	II	✓	80	3000	OPAL	-	-	6100	■	GWS3258PLD30K	✓
26	II	✓	80	4000	OPAL	-	-	3250	■	GWS3158PLD	✓

SMART [3] 1600 TRANSPARENT

IP66/69 - IK08 - 850 °C



LUMINAIRE WATTAGE [W]	CLASS	ENEC	CRI	KELVIN	OPTIC	BEAM ANGLE	LIGHTSOURCE LUMEN OUTPUT [lm]	LUMINAIRE LUMEN OUTPUT [lm]	COLOUR / FINISH	PART NUMBER	UKCA
Power LED 220-240 V 50/60 Hz											
50	II	✓	80	5700	TRNSP	-	-	6700	■	GWS3258T57K	✓
50	II	✓	80	4000	TRNSP	-	-	6700	■	GWS3258T	✓
50	II	✓	80	3000	TRNSP	-	-	6400	■	GWS3258T30K	✓
26	II	✓	80	4000	TRNSP	-	-	3400	■	GWS3158T	✓
Power LED 220-240 V 50/60 Hz - through-wiring											
50	II	✓	80	5700	TRNSP	-	-	6700	■	GWS3258TL57K	✓
50	II	✓	80	4000	TRNSP	-	-	6700	■	GWS3258TL	✓
50	II	✓	80	3000	TRNSP	-	-	6400	■	GWS3258TL30K	✓
26	II	✓	80	4000	TRNSP	-	-	3400	■	GWS3158TL	✓
Power LED dimmable DALI - 220-240 V 50/60 Hz											
50	II	✓	80	5700	TRNSP	-	-	6700	■	GWS3258TD57K	✓
50	II	✓	80	4000	TRNSP	-	-	6700	■	GWS3258TD	✓
50	II	✓	80	3000	TRNSP	-	-	6400	■	GWS3258TD30K	✓
26	II	✓	80	4000	TRNSP	-	-	3400	■	GWS3158TD	✓
Power LED dimmable DALI 220-240 V 50/60 Hz - through-wiring											
50	II	✓	80	5700	TRNSP	-	-	6700	■	GWS3258TLD57K	✓
50	II	✓	80	4000	TRNSP	-	-	6700	■	GWS3258TLD	✓
50	II	✓	80	3000	TRNSP	-	-	6400	■	GWS3258TLD30K	✓
26	II	✓	80	4000	TRNSP	-	-	3400	■	GWS3158TLD	✓

Optional accessories

DESCRIPTION	COLOR	PART NUMBER	UKCA
SMART [3]			
Wall-mounting bracket 30°/45°		GWS3191	✓
Rigid pipe adaptor		GWS3193	✓
Male connector 4 poles 10 A		GWS3194	✓
Continuous line connection kit		GWS3197	✓
Emergency kit 3h for through wiring version		GWS3198	✓
RINA clamp kit		GWS3296	✓



GWS3194

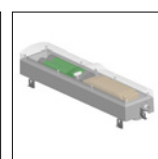

GWS3198

SMART [3]E

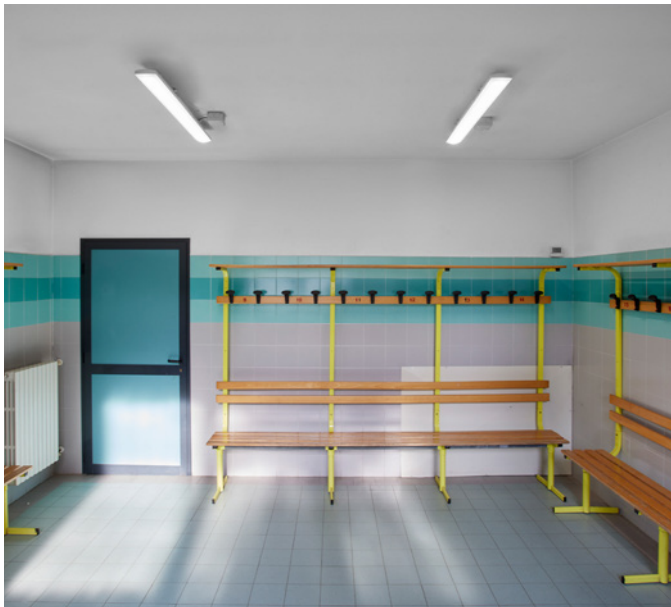

Municipal stadium Giovanni Battista Maffei - Brescia - Italy

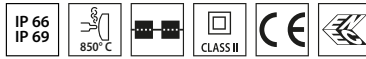

Scan the QR-code for the latest information

■ Grey RAL 7035 / Grey RAL7035 /

Watertight fixture IP66/69/69 for industrial applications, ideal for production areas, warehouses, and logistics areas

- Designed to replace fluorescent devices and lowbays up to 6,500lm
- IK08 body in RAL7035 colored self-exhausting polycarbonate
- Available in 2 sizes: 800 mm and 1200 mm
- Available in 4000K and 5700K with CRI ≥ 80
- Available with powers ranging from 34 W to 52 W and flux ranging from 3,700 lm to 6,300 lm
- Mid-power LED with wire bonding
- Equipped with integrated On/Off driver
- The through wiring version has pre-wired mechanical and electrical connections, allowing up to 25 fixtures installed in a continuous row
- Available in 2 different optical solutions: transparent or opal diffuser in UV-stabilized, self-extinguishing polycarbonate
- The device can be hung or wall-mounted through bracket accessory with a tilt of 30° or 45° on the vertical axis
- Available with external emergency kit with 3h autonomy compatible with through wiring versions (to be ordered separately)

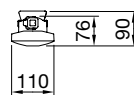
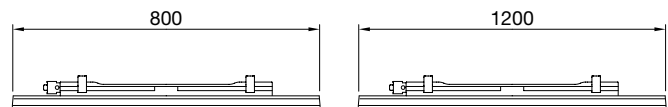

SMART [3]E
800

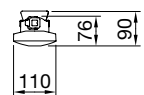

SMART [3]E
1200

SMART [3]E 800 OPAL

IP66/69 - IK08 - 850 °C

LUMINAIRE WATTAGE [W]	CLASS	ENEC	CRI	KELVIN	OPTIC	BEAM ANGLE	LIGHTSOURCE LUMEN OUTPUT (lm)	LUMINAIRE LUMEN OUTPUT (lm)	COLOUR / FINISH	PART NUMBER	UKCA
Power LED 220-240 V 50/60 Hz											
34	II	✓	80	5700	OPAL	-	-	3700	■	GWS3120EP857	✓
34	II	✓	80	4000	OPAL	-	-	3700	■	GWS3120EP840	✓



SMART [3]E 800 TRANSPARENT

IP66/69 - IK08 - 850 °C

LUMINAIRE WATTAGE [W]	CLASS	ENEC	CRI	KELVIN	OPTIC	BEAM ANGLE	LIGHTSOURCE LUMEN OUTPUT (lm)	LUMINAIRE LUMEN OUTPUT (lm)	COLOUR / FINISH	PART NUMBER	UKCA
Power LED 220-240 V 50/60 Hz											
34	II	✓	80	5700	TRNSP	-	-	3900	■	GWS3120ET857	✓
34	II	✓	80	4000	TRNSP	-	-	3900	■	GWS3120ET840	✓



SMART [3]E 1200 OPAL

IP66/69 - IK08 - 850 °C

LUMINAIRE WATTAGE [W]	CLASS	ENEC	CRI	KELVIN	OPTIC	BEAM ANGLE	LIGHTSOURCE LUMEN OUTPUT (lm)	LUMINAIRE LUMEN OUTPUT (lm)	COLOUR / FINISH	PART NUMBER	UKCA
Power LED 220-240 V 50/60 Hz											
52	II	✓	80	5700	OPAL	-	-	6000	■	GWS3220EP857	✓
52	II	✓	80	4000	OPAL	-	-	6000	■	GWS3220EP840	✓
Power LED 220-240 V 50/60 Hz - through-wiring											
52	II	✓	80	5700	OPAL	-	-	6000	■	GWS3222EP857	✓
52	II	✓	80	4000	OPAL	-	-	6000	■	GWS3222EP840	✓



SMART [3]E 1200 TRANSPARENT

IP66/69 - IK08 - 850 °C

LUMINAIRE WATTAGE [W]	CLASS	ENEC	CRI	KELVIN	OPTIC	BEAM ANGLE	LIGHTSOURCE LUMEN OUTPUT (lm)	LUMINAIRE LUMEN OUTPUT (lm)	COLOUR / FINISH	PART NUMBER	UKCA
Power LED 220-240 V 50/60 Hz											
52	II	✓	80	5700	TRNSP	-	-	6300	■	GWS3220ET857	✓
52	II	✓	80	4000	TRNSP	-	-	6300	■	GWS3220ET840	✓
Power LED 220-240 V 50/60 Hz - through-wiring											
52	II	✓	80	5700	TRNSP	-	-	6300	■	GWS3222ET857	✓
52	II	✓	80	4000	TRNSP	-	-	6300	■	GWS3222ET840	✓



Industrial

Optional accessories

DESCRIPTION	COLOR	PART NUMBER	UKCA
SMART [3]E			
Wall-mounting bracket 30°/45°		GWS3191	✓
Rigid pipe adaptor		GWS3193	✓
Male connector 4 poles 10 A		GWS3194	✓
Continuous line connection kit		GWS3197	✓
Emergency kit 3h for through wiring version		GWS3198	✓
RINA clamp kit		GWS3296	✓



GWS3194

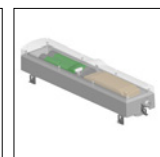

GWS3198

Residential



Residential Building De Bever - Heerhugowaard - Netherlands

We study high-performance solutions that combine efficiency and durability. Lighting for residential contexts, historic homes, holiday homes and gardens: the outdoor lighting design includes a variety of solutions suited to each context. For us, safety and durability are always of prime consideration.



EXTRO

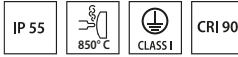
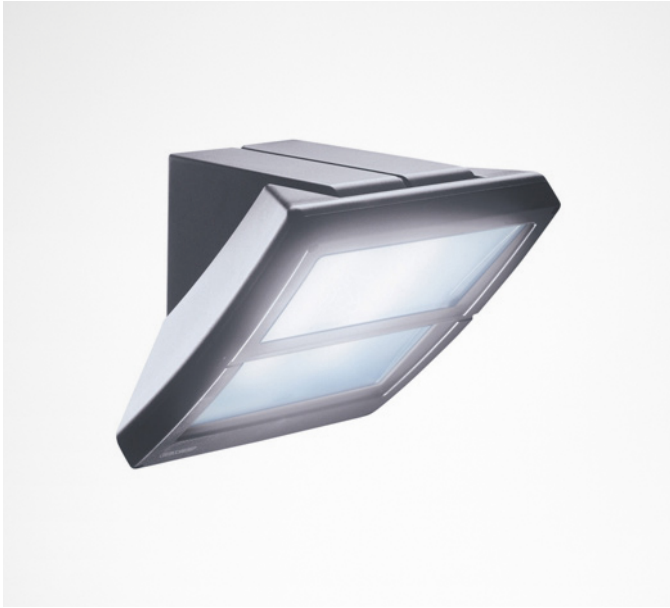

Scan the QR-code for the latest information

■ Graphite grey / Graphite grey /

Multifunctional lighting device for residential and urban areas with body made in PC

- Also available in 13W and 26W LED versions
- Sandblasted glass diffuser
- Possibility of wall, ceiling, pole and column mounting

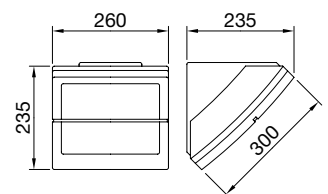

EXTRO

EXTRO LED

IP55 - IK09 - 850 °C

LAMPHOLDER	LUMINAIRE WATTAGE [W]	CLASS	ENEC	CRI	KELVIN	OPTIC	BEAM ANGLE	LIGHTSOURCE LUMEN OUTPUT [lm]	LUMINAIRE LUMEN OUTPUT [lm]	COLOUR / FINISH	PART NUMBER	UKCA
Power LED 220-240 V 50/60 Hz												
LED	26	I	-	90	4000	OPAL	-	-	1950	■	GWS2402	✓
LED	26	I	-	90	3000	OPAL	-	-	1850	■	GWS240230K	✓
LED	13	I	-	90	4000	OPAL	-	-	1000	■	GWS2401	✓
LED	13	I	-	90	3000	OPAL	-	-	950	■	GWS240130K	✓



EXTRO E27

IP55 - IK09 - 850 °C

LAMPHOLDER	LUMINAIRE WATTAGE [W]	CLASS	ENEC	CRI	KELVIN	OPTIC	BEAM ANGLE	LIGHTSOURCE LUMEN OUTPUT [lm]	LUMINAIRE LUMEN OUTPUT [lm]	COLOUR / FINISH	PART NUMBER	UKCA
E27 220-240 V 50/60 Hz												
E27	-	I	-	-	-	OPAL	-	-	-	■	GW82206	✓



Optional accessories

DESCRIPTION	COLOR	PART NUMBER	UKCA
EXTRO			
Swivel bracket		GW82290	✓
Angle bracket		GW82291	✓
Pole mounting single swivel bracket		GW82298	✓
Pole mounting double swivel bracket		GW82299	✓
Rectangular base for support column		GW82297	✓
Pole for single device h = 1300 mm		GW82292	✓
Replacement glass		GW88272	✓



GW82290

GW82291

GW82298



GW82299

GW82297

GW82292



GW88272

ELIA EL

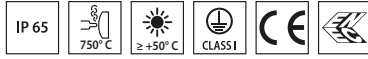

Scan the QR-code for the latest information

- BK-RAL9005 / Black RAL9005 /
- WH-RAL9016 / White RAL9016 /

Die-cast aluminum LED luminaire for ceiling or wall mounting, ideal for the lighting of exteriors and interiors such as: stairs, passageways, service rooms, simple and quick to install, with a clean line and essential

- Designed in two different finishes (black and white), with opal diffuser in polycarbonate, color temperatures 3.000K, 4.000 K and 5.700 K and color rendering index higher than 80
- It has been designed to withstand temperature variations from -20 °C to + 50 °C, water and dust penetration up to IP65 degree and shocks up to IK08 degree
- Lightweight and handy ELIA EL is easy to install thanks to the quick connection terminal for the electrical wiring placed in the rear part and to the second cable outlet for pass-through wiring

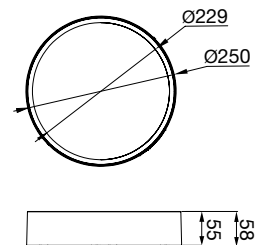
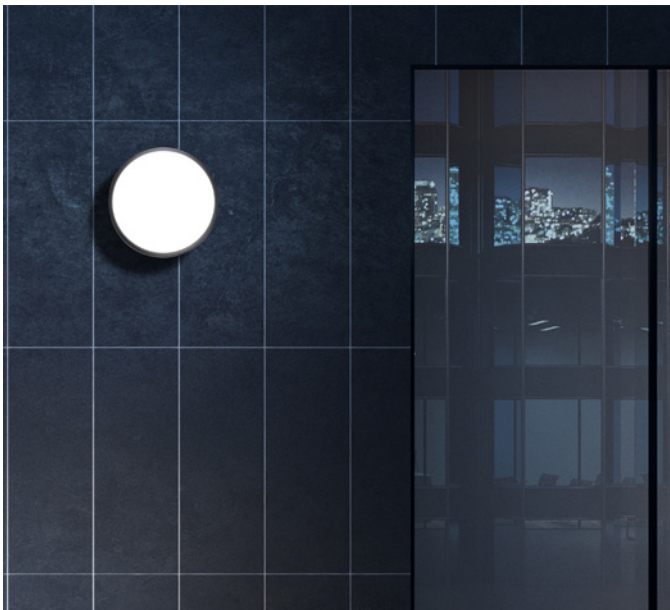

ELIA EL

ELIA EL

IP65 - IK08 - 750 °C



LUMINAIRE WATTAGE (W)	CLASS	ENEC	CRI	KELVIN	OPTIC	BEAM ANGLE	LIGHTSOURCE LUMEN OUTPUT (lm)	LUMINAIRE LUMEN OUTPUT (lm)	COLOUR / FINISH	PART NUMBER	UKCA
Power LED 220-240 V 50/60 Hz											
18	I	✓	80	5700	OPAL	-	-	1700	■	GWF2200LA857	✓
18	I	✓	80	4000	OPAL	-	-	1650	■	GWF2200LA840	✓
18	I	✓	80	3000	OPAL	-	-	1500	■	GWF2200LA830	✓
18	I	✓	80	5700	OPAL	-	-	1700	□	GWF2210LA857	✓
18	I	✓	80	4000	OPAL	-	-	1650	□	GWF2210LA840	✓
18	I	✓	80	3000	OPAL	-	-	1500	□	GWF2210LA830	✓

TONDA ES

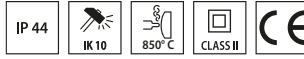

Scan the QR-code for the latest information

Compact watertight lamp, entirely made of polycarbonate and suitable for indoor and outdoor applications

- It is characterized by high shock resistance and electrical safety, with double feeding terminals: at the bottom or at the side of the luminaire

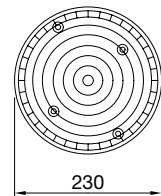
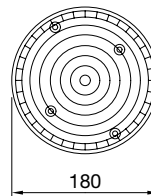
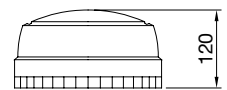
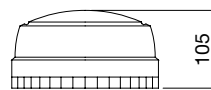

TONDA ES
180

TONDA ES
230

TONDA ES 180

IP44 - IK10 - 850 °C

LAMPHOLDER	LUMINAIRE WATTAGE [W]	CLASS	ENEC	CRI	KELVIN	OPTIC	BEAM ANGLE	LIGHTSOURCE LUMEN OUTPUT [lm]	LUMINAIRE LUMEN OUTPUT [lm]	COLOUR / FINISH	PART NUMBER	UKCA
E27 220-240 V 50/60 Hz												
E27	-	II	-	-	-	TRNSP	-	-	-		GW80651	✓



TONDA ES 230

IP44 - IK10 - 850 °C

LAMPHOLDER	LUMINAIRE WATTAGE [W]	CLASS	ENEC	CRI	KELVIN	OPTIC	BEAM ANGLE	LIGHTSOURCE LUMEN OUTPUT [lm]	LUMINAIRE LUMEN OUTPUT [lm]	COLOUR / FINISH	PART NUMBER	UKCA
E27 220-240 V 50/60 Hz												
E27	-	II	-	-	-	TRNSP	-	-	-		GW80652	✓



Architectural



Chapel of the Holy Shroud - Turin - Italy

Technology, design, and innovation. Our lighting systems emphasise shapes and enhance the material for an outstanding final result: shaping an idea. The light becomes an integral part of the creative process: we answer each need in aesthetics and functionality. With our high-tech fixtures, we offer the possibility of adjusting the intensity and the colour of the led source, in addition to numerous optical variants.



ELIA BL



Scan the QR-code for the latest information

■ BK-RAL9005 / Black RAL9005 /

Die-cast aluminum luminaire for ground mounting, ideal for bollard lighting in residential areas and passageways

- Designed in two different sizes (500mm and 700mm) with opal diffusing polycarbonate diffuser with double high and low emission) to create a comfortable atmosphere, color temperatures 3,000K, 4,000K and 5,700K and a color rendering index greater than 80
- It has been designed to withstand temperature variations from -20 °C to + 45 °C, water and dust penetration up to IP65 degree and shocks up to IK08 degree
- ELIA BL is easy to install thanks to the ground anchoring system with 4 blocking plugs

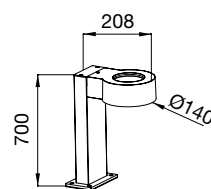

ELIA BL
L1 700

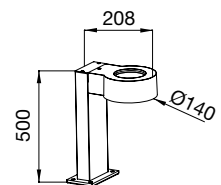

ELIA BL
M1 500

ELIA BL L1 700

IP65 - IK08 - 750 °C

LUMINAIRE WATTAGE (W)	CLASS	ENEC	CRI	KELVIN	OPTIC	BEAM ANGLE	LIGHTSOURCE LUMEN OUTPUT (lm)	LUMINAIRE LUMEN OUTPUT (lm)	COLOUR / FINISH	PART NUMBER	UKCA
Power LED 100-240 V 50/60 Hz											
8	I	✓	80	4000	OPAL	-	-	650	■	GWF2300PR840	✓
8	I	✓	80	3000	OPAL	-	-	650	■	GWF2300PR830	✓



ELIA BL M1 500

IP65 - IK08 - 750 °C

LUMINAIRE WATTAGE (W)	CLASS	ENEC	CRI	KELVIN	OPTIC	BEAM ANGLE	LIGHTSOURCE LUMEN OUTPUT (lm)	LUMINAIRE LUMEN OUTPUT (lm)	COLOUR / FINISH	PART NUMBER	UKCA
Power LED 100-240 V 50/60 Hz											
8	I	✓	80	4000	OPAL	-	-	650	■	GWF2300LR840	✓
8	I	✓	80	3000	OPAL	-	-	650	■	GWF2300LR830	✓



ELIA OL

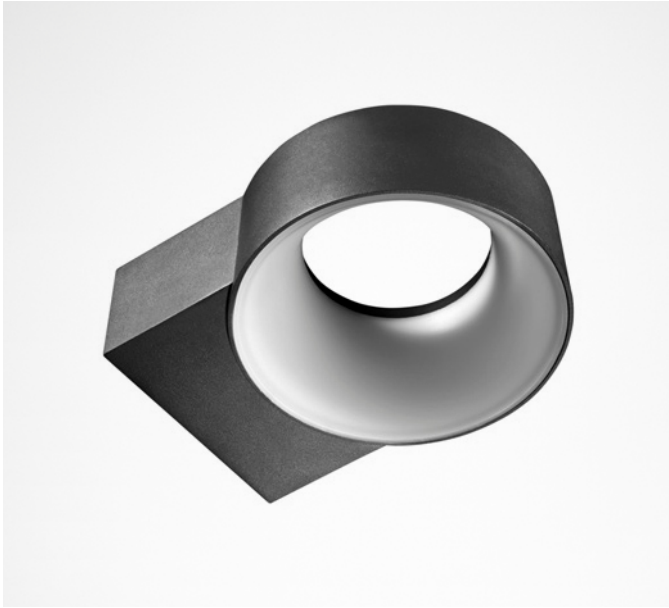

Scan the QR-code for the latest information

- BK-RAL9005 / Black RAL9005 /
- WH-RAL9016 / White RAL9016 /

Die-cast aluminum fixture for wall mounting, ideal for indoor and outdoor architectural lighting such as: stairs, passageways or facades, quick and easy to install, with a clean and essential line

- Designed in two different finishes (black and white), with double emission diffusing polycarbonate opal screen (top and down) to create a comfortable atmosphere, color temperatures of 3,000K, 4,000 K and 5,700 K and a color rendering index greater than 80
- It has been designed to withstand temperature variations from -20 °C to + 45 °C, water and dust penetration up to IP65 degree and shocks up to IK08 degree
- Light and handy, it is easy to install thanks also to the rear bracket for fixing, the quick-fit terminal placed in the back for the electrical wiring

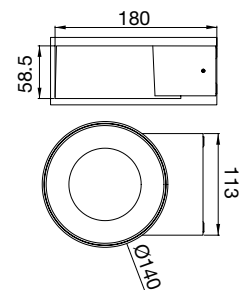

ELIA OL

ELIA OL

IP65 - IK08 - 750 °C

LUMINAIRE WATTAGE (W)	CLASS	ENEC	CRI	KELVIN	OPTIC	BEAM ANGLE	LIGHTSOURCE LUMEN OUTPUT (lm)	LUMINAIRE LUMEN OUTPUT (lm)	COLOUR / FINISH	PART NUMBER	UKCA
Power LED 100-240 V 50/60 Hz											
8	I	✓	80	4000	OPAL	-	-	650	■	GWF2100FR840	✓
8	I	✓	80	3000	OPAL	-	-	650	■	GWF2100FR830	✓
8	I	✓	80	4000	OPAL	-	-	650	□	GWF2110FR840	✓
8	I	✓	80	3000	OPAL	-	-	650	□	GWF2110FR830	✓

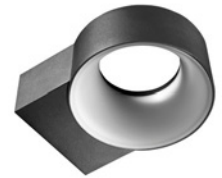

Sports and Area



Bottagisio Sport Center - Verona - Italy

From the lighting of sports facilities to airport lighting, from stadiums to the façades of the most important buildings: where the complexity and technological innovation comes into play, the extent of the range of characteristics is the key. Our lighting systems can meet the highest standards required by the project and regulations. Specialised and complex structures require highly specialised solutions



ESALITE FL

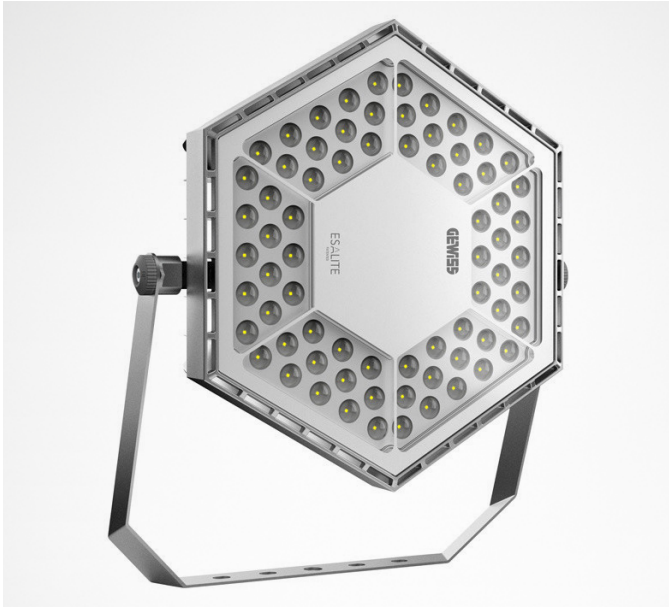

Scan the QR-code for the latest information

■ GR-RAL9006 / Grey RAL9006 /

- LED device made of die-cast EN AB 46100 aluminium with polyester powder coating
- The correct heat dispersion is guaranteed by the special passive heat sink with a very low copper content that offers high qualitative and quantitative performances
 - Correct illumination is provided by an optical system composed of different versions of lenses and sealed by an extra-clear tempered glass of 4 mm
 - Silicone gaskets, Goretex breathing and anti-condensation device, waterproof connector for 1.5 mm² cables and stainless steel external screws
 - The die-cast aluminium structure guarantees optimal performance conditions both at Ta25° and Ta50° thanks to specific thermal sizing tests
 - Integrated suspension fixing system thanks to a ring made directly in the die-cast aluminium

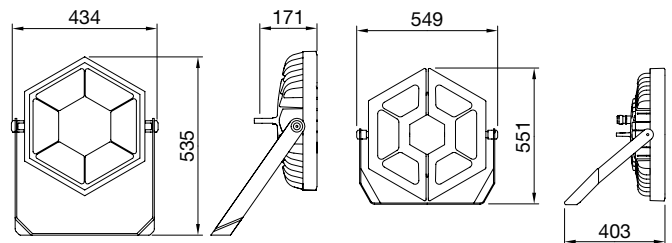

ESALITE FL
12K / 16K / 20K

ESALITE FL
24K

Identifying and classifying our optics

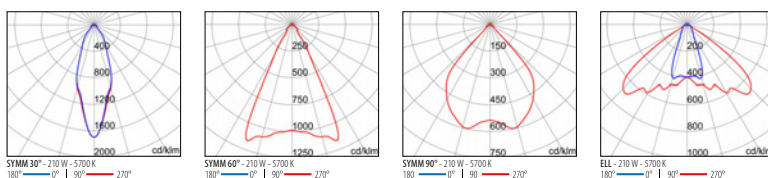

ESALITE FL 12K GLASS

IP66 - IK08

LUMINAIRE WATTAGE (W)	CLASS	ENEC	CRI	KELVIN	OPTIC	BEAM ANGLE	LIGHTSOURCE LUMEN OUTPUT (lm)	LUMINAIRE LUMEN OUTPUT (lm)	COLOUR / FINISH	PART NUMBER	UKCA
Power LED dimmable DALI - 220-240 V 50/60 Hz											
112	I	✓	80	5700	SYMM	30°	-	11600	■	GWS6422GD57K	✓
112	I	✓	80	5700	SYMM	60°	-	11900	■	GWS6423GD57K	✓
112	I	✓	80	5700	SYMM	90°	-	12700	■	GWS6424GD57K	✓
112	I	✓	80	5700	ELL	-	-	11900	■	GWS6425GD57K	✓
112	I	✓	80	4000	SYMM	30°	-	11600	■	GWS6422GD	✓
112	I	✓	80	4000	SYMM	60°	-	11900	■	GWS6423GD	✓
112	I	✓	80	4000	SYMM	90°	-	12700	■	GWS6424GD	✓
112	I	✓	80	4000	ELL	-	-	11900	■	GWS6425GD	✓
112	I	✓	80	3000	SYMM	30°	-	10800	■	GWS6422GD30K	✓
112	I	✓	80	3000	SYMM	60°	-	11100	■	GWS6423GD30K	✓
112	I	✓	80	3000	SYMM	90°	-	11800	■	GWS6424GD30K	✓
112	I	✓	80	3000	ELL	-	-	11100	■	GWS6425GD30K	✓



ESALITE FL 16K GLASS

IP66 - IK08

LUMINAIRE WATTAGE (W)	CLASS	ENEC	CRI	KELVIN	OPTIC	BEAM ANGLE	LIGHTSOURCE LUMEN OUTPUT (lm)	LUMINAIRE LUMEN OUTPUT (lm)	COLOUR / FINISH	PART NUMBER	UKCA
Power LED dimmable DALI - 220-240 V 50/60 Hz											
125	I	✓	80	5700	SYMM	30°	-	13300	■	GWS6432GD57K	✓
125	I	✓	80	5700	SYMM	60°	-	13600	■	GWS6433GD57K	✓
125	I	✓	80	5700	SYMM	90°	-	14400	■	GWS6434GD57K	✓
125	I	✓	80	5700	ELL	-	-	13600	■	GWS6435GD57K	✓
125	I	✓	80	4000	SYMM	30°	-	13300	■	GWS6432GD	✓
125	I	✓	80	4000	SYMM	60°	-	13600	■	GWS6433GD	✓
125	I	✓	80	4000	SYMM	90°	-	14400	■	GWS6434GD	✓
125	I	✓	80	4000	ELL	-	-	13600	■	GWS6435GD	✓
125	I	✓	80	3000	SYMM	30°	-	12300	■	GWS6432GD30K	✓
125	I	✓	80	3000	SYMM	60°	-	12600	■	GWS6433GD30K	✓
125	I	✓	80	3000	SYMM	90°	-	13400	■	GWS6434GD30K	✓
125	I	✓	80	3000	ELL	-	-	12600	■	GWS6435GD30K	✓



ESALITE FL 20K GLASS

IP66 - IK08

LUMINAIRE WATTAGE (W)	CLASS	ENEC	CRI	KELVIN	OPTIC	BEAM ANGLE	LIGHTSOURCE LUMEN OUTPUT (lm)	LUMINAIRE LUMEN OUTPUT (lm)	COLOUR / FINISH	PART NUMBER	UKCA
Power LED dimmable DALI - 220-240 V 50/60 Hz											
148	I	✓	80	5700	SYMM	30°	-	15500	■	GWS6442GD57K	✓
148	I	✓	80	5700	SYMM	60°	-	15800	■	GWS6443GD57K	✓
148	I	✓	80	5700	SYMM	90°	-	16800	■	GWS6444GD57K	✓
148	I	✓	80	5700	ELL	-	-	15800	■	GWS6445GD57K	✓
148	I	✓	80	4000	SYMM	30°	-	15500	■	GWS6442GD	✓
148	I	✓	80	4000	SYMM	60°	-	15800	■	GWS6443GD	✓
148	I	✓	80	4000	SYMM	90°	-	16800	■	GWS6444GD	✓
148	I	✓	80	4000	ELL	-	-	15800	■	GWS6445GD	✓
148	I	✓	80	3000	SYMM	30°	-	14400	■	GWS6442GD30K	✓
148	I	✓	80	3000	SYMM	60°	-	14700	■	GWS6443GD30K	✓
148	I	✓	80	3000	SYMM	90°	-	15600	■	GWS6444GD30K	✓
148	I	✓	80	3000	ELL	-	-	14700	■	GWS6445GD30K	✓



ESALITE FL 24K GLASS

IP66 - IK08

LUMINAIRE WATTAGE (W)	CLASS	ENEC	CRI	KELVIN	OPTIC	BEAM ANGLE	LIGHTSOURCE LUMEN OUTPUT (lm)	LUMINAIRE LUMEN OUTPUT (lm)	COLOUR / FINISH	PART NUMBER	UKCA
Power LED dimmable DALI - 220-240 V 50/60 Hz											
210	I	✓	80	5700	SYMM	30°	-	21700	■	GWS6452GD57K	✓
210	I	✓	80	5700	SYMM	60°	-	22200	■	GWS6453GD57K	✓
210	I	✓	80	5700	SYMM	90°	-	23600	■	GWS6454GD57K	✓
210	I	✓	80	5700	ELL	-	-	22200	■	GWS6455GD57K	✓
210	I	✓	80	4000	SYMM	30°	-	21700	■	GWS6452GD	✓
210	I	✓	80	4000	SYMM	60°	-	22200	■	GWS6453GD	✓
210	I	✓	80	4000	SYMM	90°	-	23600	■	GWS6454GD	✓
210	I	✓	80	4000	ELL	-	-	22200	■	GWS6455GD	✓
210	I	✓	80	3000	SYMM	30°	-	20200	■	GWS6452GD30K	✓
210	I	✓	80	3000	SYMM	60°	-	20600	■	GWS6453GD30K	✓
210	I	✓	80	3000	SYMM	90°	-	21900	■	GWS6454GD30K	✓
210	I	✓	80	3000	ELL	-	-	20600	■	GWS6455GD30K	✓

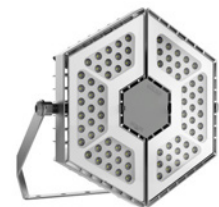

ELIA FL MINI XS1

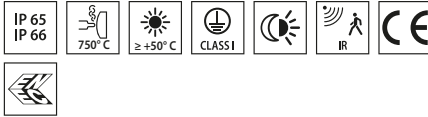

Scan the QR-code for the latest information

■ Black RAL 9017 / Black RAL9017 /

Low-power LED floodlight for indoor and outdoor architectural lighting for both residential and professional applications, such as façades, gardens, green areas and walkways

- Thanks to its black powder-coated die-cast aluminium body and its front glass, it is tough, durable and able to withstand harsh environmental conditions
- Available in 2 sizes and 3 power steps (10 W, 20 W and 30 W), the range allows for great flexibility with its multiple possible combinations: 2 colour temperature options (3,000 K warm white and 4,000 K neutral white) with a colour rendering index of more than 80, and 2 optics options (100° or asymmetrical)
- The fixture is equipped with an integrated On/Off electronic power supply, and it is also available with an integrated motion and luminosity sensor
- The luminaire can be ceiling, wall or floor-mounted through the integrated adjustable steel bracket

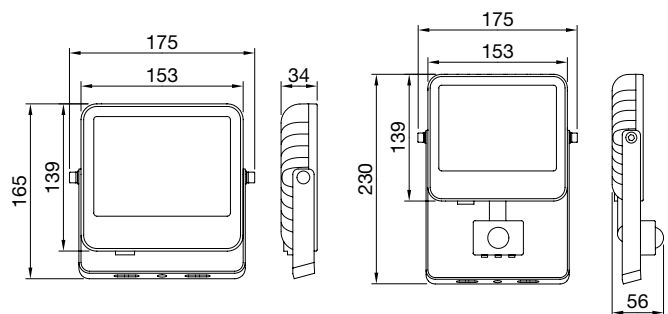

ELIA FL MINI XS1 10W*

ELIA FL MINI XS1 10W
PIR

Identifying and classifying our optics

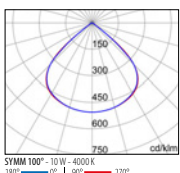

ELIA FL MINI XS1 10W 100°

IP66 - IK08 - 750 °C

LUMINAIRE WATTAGE (W)	CLASS	ENEC	CRI	KELVIN	OPTIC	BEAM ANGLE	LIGHTSOURCE LUMEN OUTPUT (lm)	LUMINAIRE LUMEN OUTPUT (lm)	COLOUR / FINISH	PART NUMBER	UKCA
Power LED 220-240 V 50/60 Hz											
10	I	✓	80	4000	SYMM	100°	-	1500	■	GWF1100AL840	✓
10	I	✓	80	3000	SYMM	100°	-	1400	■	GWF1100AL830	✓



ELIA FL MINI XS1 10W 100° PIR

IP65 - IK08 - 750 °C

LUMINAIRE WATTAGE (W)	CLASS	ENEC	CRI	KELVIN	OPTIC	BEAM ANGLE	LIGHTSOURCE LUMEN OUTPUT (lm)	LUMINAIRE LUMEN OUTPUT (lm)	COLOUR / FINISH	PART NUMBER	UKCA
Power LED 220-240 V 50/60 Hz + PIR sensor											
10	I	✓	80	4000	SYMM	100°	-	1500	■	GWF1105AL840	✓
10	I	✓	80	3000	SYMM	100°	-	1400	■	GWF1105AL830	✓



ELIA FL MINI XS2

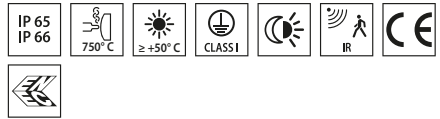

■ Black RAL 9017 / Black RAL9017 /

Scan the QR-code for the latest information

Low-power LED floodlight for indoor and outdoor architectural lighting for both residential and professional applications, such as façades, gardens, green areas and walkways

- Thanks to its black powder-coated die-cast aluminium body and its front glass, it is tough, durable and able to withstand harsh environmental conditions
- Available in 2 sizes and 3 power steps (10 W, 20 W and 30 W), the range allows for great flexibility with its multiple possible combinations: 2 colour temperature options (3,000 K warm white and 4,000 K neutral white) with a colour rendering index of more than 80, and 2 optics options (100° or asymmetrical)
- The fixture is equipped with an integrated On/Off electronic power supply, and it is also available with an integrated motion and luminosity sensor
- The luminaire can be ceiling, wall or floor-mounted through the integrated adjustable steel bracket

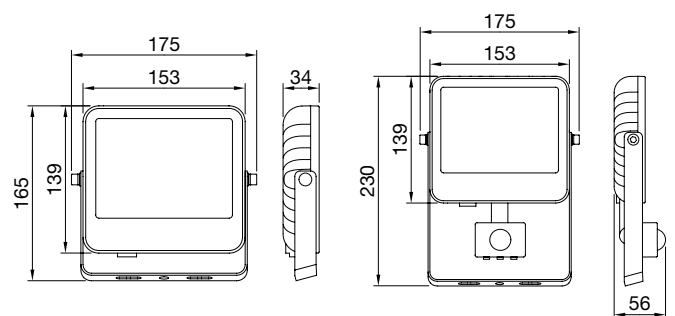

ELIA FL MINI XS2 20W

ELIA FL MINI XS2 20W
PIR

Identifying and classifying our optics

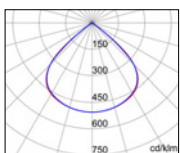

ELIA FL MINI XS2 20W 100°

IP66 - IK08 - 750 °C

LUMINAIRE WATTAGE (W)	CLASS	ENEC	CRI	KELVIN	OPTIC	BEAM ANGLE	LIGHTSOURCE LUMEN OUTPUT (lm)	LUMINAIRE LUMEN OUTPUT (lm)	COLOUR / FINISH	PART NUMBER	UKCA
Power LED 220-240 V 50/60 Hz											
20	I	✓	80	4000	SYMM	100°	-	2400	■	GWF1100BL840	✓
20	I	✓	80	3000	SYMM	100°	-	2300	■	GWF1100BL830	✓



ELIA FL MINI XS2 20W 100° PIR

IP65 - IK08 - 750 °C

LUMINAIRE WATTAGE (W)	CLASS	ENEC	CRI	KELVIN	OPTIC	BEAM ANGLE	LIGHTSOURCE LUMEN OUTPUT (lm)	LUMINAIRE LUMEN OUTPUT (lm)	COLOUR / FINISH	PART NUMBER	UKCA
Power LED 220-240 V 50/60 Hz + PIR sensor											
20	I	✓	80	4000	SYMM	100°	-	2400	■	GWF1105BL840	✓
20	I	✓	80	3000	SYMM	100°	-	2300	■	GWF1105BL830	✓



ELIA FL MINI XS3

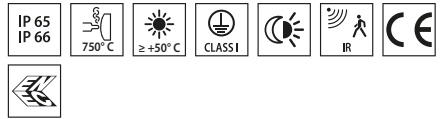

■ Black RAL 9017 / Black RAL9017 /

Scan the QR-code for the latest information

Low-power LED floodlight for indoor and outdoor architectural lighting for both residential and professional applications, such as façades, gardens, green areas and walkways

- Thanks to its black powder-coated die-cast aluminium body and its front glass, it is tough, durable and able to withstand harsh environmental conditions
- Available in 2 sizes and 3 power steps (10 W, 20 W and 30 W), the range allows for great flexibility with its multiple possible combinations: 2 colour temperature options (3,000 K warm white and 4,000 K neutral white) with a colour rendering index of more than 80, and 2 optics options (100° or asymmetrical)
- The fixture is equipped with an integrated On/Off electronic power supply, and it is also available with an integrated motion and luminosity sensor
- The luminaire can be ceiling, wall or floor-mounted through the integrated adjustable steel bracket

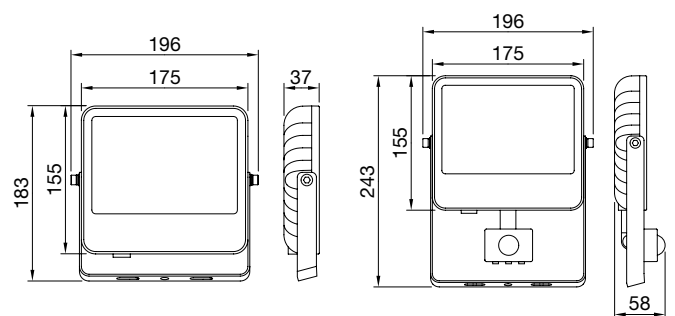

ELIA FL MINI XS3 30W

ELIA FL MINI XS3 30W PIR

Identifying and classifying our optics

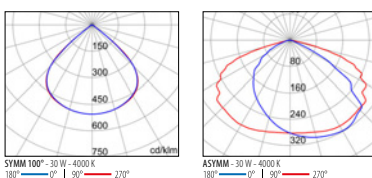

ELIA FL MINI XS3 30W 100°

IP66 - IK08 - 750 °C

LUMINAIRE WATTAGE (W)	CLASS	ENEC	CRI	KELVIN	OPTIC	BEAM ANGLE	LIGHTSOURCE LUMEN OUTPUT (lm)	LUMINAIRE LUMEN OUTPUT (lm)	COLOUR / FINISH	PART NUMBER	UKCA
Power LED 220-240 V 50/60 Hz											
30	I	✓	80	4000	SYMM	100°	-	4000	■	GWF1100CL840	✓
30	I	✓	80	3000	SYMM	100°	-	3900	■	GWF1100CL830	✓



ELIA FL MINI XS3 30W 100° PIR

IP65 - IK08 - 750 °C

LUMINAIRE WATTAGE (W)	CLASS	ENEC	CRI	KELVIN	OPTIC	BEAM ANGLE	LIGHTSOURCE LUMEN OUTPUT (lm)	LUMINAIRE LUMEN OUTPUT (lm)	COLOUR / FINISH	PART NUMBER	UKCA
Power LED 220-240 V 50/60 Hz + PIR sensor											
30	I	✓	80	4000	SYMM	100°	-	4000	■	GWF1105CL840	✓
30	I	✓	80	3000	SYMM	100°	-	3900	■	GWF1105CL830	✓



ELIA FL MINI XS3 30W ASYMMETRIC

IP66 - IK08 - 750 °C

LUMINAIRE WATTAGE (W)	CLASS	ENEC	CRI	KELVIN	OPTIC	BEAM ANGLE	LIGHTSOURCE LUMEN OUTPUT (lm)	LUMINAIRE LUMEN OUTPUT (lm)	COLOUR / FINISH	PART NUMBER	UKCA
Power LED 220-240 V 50/60 Hz											
30	I	✓	80	4000	ASYMM	-	-	3700	■	GWF1100CC840	✓
30	I	✓	80	3000	ASYMM	-	-	3600	■	GWF1100CC830	✓



ELIA FL MINI XS3 30W ASYMMETRIC PIR

IP65 - IK08 - 750 °C

LUMINAIRE WATTAGE (W)	CLASS	ENEC	CRI	KELVIN	OPTIC	BEAM ANGLE	LIGHTSOURCE LUMEN OUTPUT (lm)	LUMINAIRE LUMEN OUTPUT (lm)	COLOUR / FINISH	PART NUMBER	UKCA
Power LED 220-240 V 50/60 Hz + PIR sensor											
30	I	✓	80	4000	ASYMM	-	-	3700	■	GWF1105CC840	✓
30	I	✓	80	3000	ASYMM	-	-	3600	■	GWF1105CC830	✓



ELIA FL S3

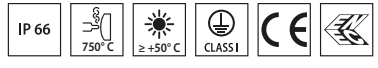

■ Black RAL 9017 / Black RAL9017 /

Scan the QR-code for the latest information

LED floodlight, available in medium and high-power versions for outdoor and indoor applications in industrial, tertiary and sports contexts, such as façades, warehouses, car parks and sports fields

- Thanks to its black powder-coated die-cast aluminium body and its front glass, the fixture is tough, durable (IP66 and IK08) and is able to withstand harsh environmental conditions (such as ambient temperature variations from -30°C to +50°C)
- Available in 4 different sizes and power steps (50 W, 100 W, 150 W and 200 W), the range allows for great flexibility with its multiple possible combinations: 3 colour temperature options (3,000 K warm white, 4,000 K neutral white and 5,700 K cool white) with a colour rendering index of more than 80; 2 integrated power supply options (On/Off and DALI); and 2 optics options (60° and asymmetrical)
- The luminaire can be ceiling, wall or floor-mounted through the integrated adjustable steel bracket with a protractor, or pole-mounted (in poles with diameter up to 61 mm) through a dedicated accessory (to be ordered separately)

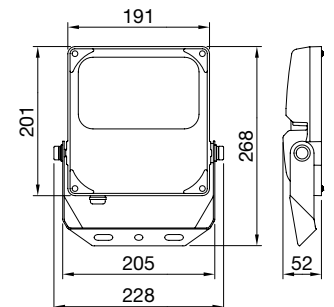

ELIA FL S3 50W

Identifying and classifying our optics

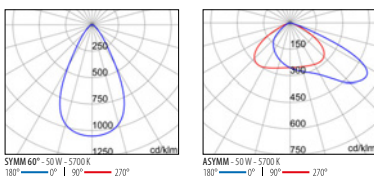

ELIA FL S3 50W 60°

IP66 - IK08 - 750 °C

LUMINAIRE WATTAGE (W)	CLASS	ENEC	CRI	KELVIN	OPTIC	BEAM ANGLE	LIGHTSOURCE LUMEN OUTPUT (lm)	LUMINAIRE LUMEN OUTPUT (lm)	COLOUR / FINISH	PART NUMBER	UKCA
Power LED 220-240 V 50/60 Hz											
50	I	✓	80	5700	SYMM	60°	-	6800	■	GWF1100HH857	✓
50	I	✓	80	4000	SYMM	60°	-	6800	■	GWF1100HH840	✓
50	I	✓	80	3000	SYMM	60°	-	6600	■	GWF1100HH830	✓



ELIA FL S3 50W ASYMMETRIC

IP66 - IK08 - 750 °C

LUMINAIRE WATTAGE (W)	CLASS	ENEC	CRI	KELVIN	OPTIC	BEAM ANGLE	LIGHTSOURCE LUMEN OUTPUT (lm)	LUMINAIRE LUMEN OUTPUT (lm)	COLOUR / FINISH	PART NUMBER	UKCA
Power LED 220-240 V 50/60 Hz											
50	I	✓	80	5700	ASYMM	-	-	6400	■	GWF1100HC857	✓
50	I	✓	80	4000	ASYMM	-	-	6400	■	GWF1100HC840	✓
50	I	✓	80	3000	ASYMM	-	-	6200	■	GWF1100HC830	✓



Optional accessories

DESCRIPTION	COLOR	PART NUMBER	UKCA
ELIA FL S3 Headpole - black		GWF1901	✓



GWF1901

ELIA FL M3

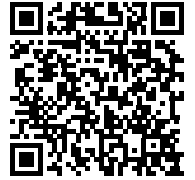
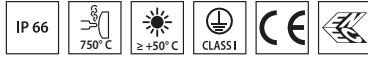

Scan the QR-code for the latest information

■ Black RAL 9017 / Black RAL9017 /

LED floodlight, available in medium and high-power versions for outdoor and indoor applications in industrial, tertiary and sports contexts, such as façades, warehouses, car parks and sports fields

- Thanks to its black powder-coated die-cast aluminium body and its front glass, the fixture is tough, durable (IP66 and IK08) and is able to withstand harsh environmental conditions (such as ambient temperature variations from -30°C to +50°C)
- Available in 4 different sizes and power steps (50 W, 100 W, 150 W and 200 W), the range allows for great flexibility with its multiple possible combinations: 3 colour temperature options (3,000 K warm white, 4,000 K neutral white and 5,700 K cool white) with a colour rendering index of more than 80; 2 integrated power supply options (On/Off and DALI); and 2 optics options (60° and asymmetrical)
- The luminaire can be ceiling, wall or floor-mounted through the integrated adjustable steel bracket with a protractor, or pole-mounted (in poles with diameter up to 61 mm) through a dedicated accessory (to be ordered separately)

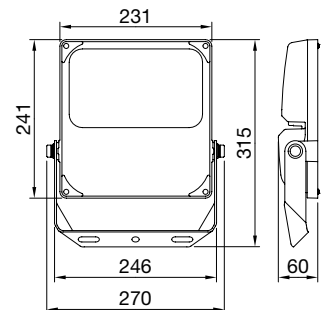

ELIA FL M3 100W

Identifying and classifying our optics

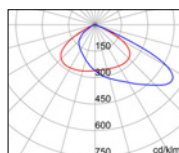
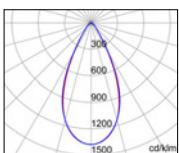

ELIA FL M3 100W 60°

IP66 - IK08 - 750 °C

LUMINAIRE WATTAGE (W)	CLASS	ENEC	CRI	KELVIN	OPTIC	BEAM ANGLE	LIGHTSOURCE LUMEN OUTPUT (lm)	LUMINAIRE LUMEN OUTPUT (lm)	COLOUR / FINISH	PART NUMBER	UKCA
Power LED 220-240 V 50/60 Hz											
100	I	✓	80	5700	SYMM	60°	-	13800	■	GWF1100NH857	✓
100	I	✓	80	4000	SYMM	60°	-	13800	■	GWF1100NH840	✓
100	I	✓	80	3000	SYMM	60°	-	13300	■	GWF1100NH830	✓



ELIA FL M3 100W ASYMMETRIC

IP66 - IK08 - 750 °C

LUMINAIRE WATTAGE (W)	CLASS	ENEC	CRI	KELVIN	OPTIC	BEAM ANGLE	LIGHTSOURCE LUMEN OUTPUT (lm)	LUMINAIRE LUMEN OUTPUT (lm)	COLOUR / FINISH	PART NUMBER	UKCA
Power LED 220-240 V 50/60 Hz											
100	I	✓	80	5700	ASYMM	-	-	13400	■	GWF1100NC857	✓
100	I	✓	80	4000	ASYMM	-	-	13400	■	GWF1100NC840	✓
100	I	✓	80	3000	ASYMM	-	-	12900	■	GWF1100NC830	✓



Optional accessories

DESCRIPTION	COLOR	PART NUMBER	UKCA
ELIA FL M3			
Headpole - black		GWF1901	✓



GWF1901

ELIA FL L3

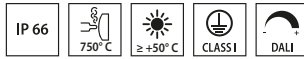

Scan the QR-code for the latest information

■ Black RAL 9017 / Black RAL9017 /

LED floodlight, available in medium and high-power versions for outdoor and indoor applications in industrial, tertiary and sports contexts, such as façades, warehouses, car parks and sports fields

- Thanks to its black powder-coated die-cast aluminium body and its front glass, the fixture is tough, durable (IP66 and IK08) and is able to withstand harsh environmental conditions (such as ambient temperature variations from -30°C to +50°C)
- Available in 4 different sizes and power steps (50 W, 100 W, 150 W and 200 W), the range allows for great flexibility with its multiple possible combinations: 3 colour temperature options (3,000 K warm white, 4,000 K neutral white and 5,700 K cool white) with a colour rendering index of more than 80; 2 integrated power supply options (On/Off and DALI); and 2 optics options (60° and asymmetrical)
- The luminaire can be ceiling, wall or floor-mounted through the integrated adjustable steel bracket with a protractor, or pole-mounted (in poles with diameter up to 61 mm) through a dedicated accessory (to be ordered separately)

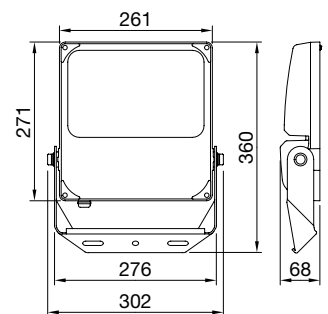

ELIA FL L3 150W

Identifying and classifying our optics

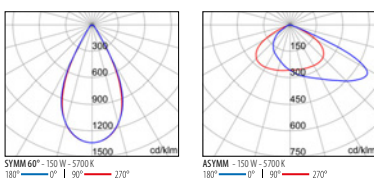

ELIA FL L3 150W 60°

IP66 - IK08 - 750 °C

LUMINAIRE WATTAGE (W)	CLASS	ENEC	CRI	KELVIN	OPTIC	BEAM ANGLE	LIGHTSOURCE LUMEN OUTPUT (lm)	LUMINAIRE LUMEN OUTPUT (lm)	COLOUR / FINISH	PART NUMBER	UKCA
Power LED 220-240 V 50/60 Hz											
150	I	-	80	5700	SYMM	60°	-	21200	■	GWF1100RH857	✓
150	I	-	80	4000	SYMM	60°	-	21200	■	GWF1100RH840	✓
150	I	-	80	3000	SYMM	60°	-	20400	■	GWF1100RH830	✓
Power LED dimmable DALI - 220-240 V 50/60 Hz											
150	I	-	80	4000	SYMM	60°	-	21200	■	GWF1101RH840	✓



ELIA FL L3 150W ASYMMETRIC

IP66 - IK08 - 750 °C

LUMINAIRE WATTAGE (W)	CLASS	ENEC	CRI	KELVIN	OPTIC	BEAM ANGLE	LIGHTSOURCE LUMEN OUTPUT (lm)	LUMINAIRE LUMEN OUTPUT (lm)	COLOUR / FINISH	PART NUMBER	UKCA
Power LED 220-240 V 50/60 Hz											
150	I	-	80	5700	ASYMM	-	-	20600	■	GWF1100RC857	✓
150	I	-	80	4000	ASYMM	-	-	20600	■	GWF1100RC840	✓
150	I	-	80	3000	ASYMM	-	-	19900	■	GWF1100RC830	✓
Power LED dimmable DALI - 220-240 V 50/60 Hz											
150	I	-	80	4000	ASYMM	-	-	20600	■	GWF1101RC840	✓



Optional accessories

DESCRIPTION	COLOR	PART NUMBER	UKCA
ELIA FL L3			
Headpole - black		GWF1901	✓



GWF1901

ELIA FL XL3



Scan the QR-code for the latest information

■ Black RAL 9017 / Black RAL9017 /

LED floodlight, available in medium and high-power versions for outdoor and indoor applications in industrial, tertiary and sports contexts, such as façades, warehouses, car parks and sports fields

- Thanks to its black powder-coated die-cast aluminium body and its front glass, the fixture is tough, durable (IP66 and IK08) and is able to withstand harsh environmental conditions (such as ambient temperature variations from -30°C to +50°C)
- Available in 4 different sizes and power steps (50 W, 100 W, 150 W and 200 W), the range allows for great flexibility with its multiple possible combinations: 3 colour temperature options (3,000 K warm white, 4,000 K neutral white and 5,700 K cool white) with a colour rendering index of more than 80; 2 integrated power supply options (On/Off and DALI); and 2 optics options (60° and asymmetrical)
- The luminaire can be ceiling, wall or floor-mounted through the integrated adjustable steel bracket with a protractor, or pole-mounted (in poles with diameter up to 61 mm) through a dedicated accessory (to be ordered separately)

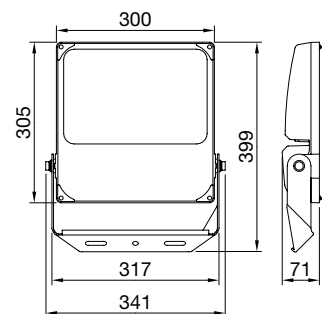

ELIA FL XL3 200W

Identifying and classifying our optics

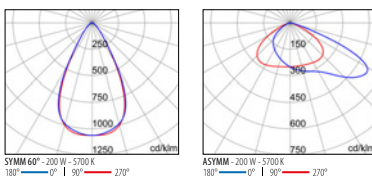

ELIA FL XL3 200W 60°

IP66 - IK08 - 750 °C

LUMINAIRE WATTAGE (W)	CLASS	ENEC	CRI	KELVIN	OPTIC	BEAM ANGLE	LIGHTSOURCE LUMEN OUTPUT (lm)	LUMINAIRE LUMEN OUTPUT (lm)	COLOUR / FINISH	PART NUMBER	UKCA
Power LED 220-240 V 50/60 Hz											
200	I	✓	80	5700	SYMM	60°	-	27900	■	GWF1100ZH857	✓
200	I	✓	80	4000	SYMM	60°	-	27900	■	GWF1100ZH840	✓
200	I	✓	80	3000	SYMM	60°	-	26900	■	GWF1100ZH830	✓
Power LED dimmable DALI - 220-240 V 50/60 Hz											
200	I	✓	80	4000	SYMM	60°	-	27900	■	GWF1101ZH840	✓



ELIA FL XL3 200W ASYMMETRIC

IP66 - IK08 - 750 °C

LUMINAIRE WATTAGE (W)	CLASS	ENEC	CRI	KELVIN	OPTIC	BEAM ANGLE	LIGHTSOURCE LUMEN OUTPUT (lm)	LUMINAIRE LUMEN OUTPUT (lm)	COLOUR / FINISH	PART NUMBER	UKCA
Power LED 220-240 V 50/60 Hz											
200	I	✓	80	5700	ASYMM	-	-	27600	■	GWF1100ZC857	✓
200	I	✓	80	4000	ASYMM	-	-	27600	■	GWF1100ZC840	✓
200	I	✓	80	3000	ASYMM	-	-	26600	■	GWF1100ZC830	✓
Power LED dimmable DALI - 220-240 V 50/60 Hz											
200	I	✓	80	4000	ASYMM	-	-	27600	■	GWF1101ZC840	✓



Optional accessories

DESCRIPTION	COLOR	PART NUMBER	UKCA
ELIA FL XL3 Headpole - black		GWF1901	✓



GWF1901

SMART [PRO]E 1M



■ Graphite grey / Graphite grey /

Scan the QR-code for the latest information

Medium-power outdoor and indoor LED floodlight, ideal for lighting small to medium-sized areas and sports facilities

- The main body is made in die cast aluminium EN AB 46100, with an integrated passive heat sink, and powder coated polyester frame with trivalent passivation
- Available with five different types of optics, three types of Correlated Colour Temperature (3000K/4000K/5700K) and two different types of Colour Rendering Index (CRI70, CRI80)
- COB LED technology for high efficacy
- Built-in 1-10V dimmable driver
- Designed to withstand surges up to 6 kV (differential mode) and 10 kV (common mode), temperature variations from -30°C to +40°C, water and dust penetration up to IP66, and impact up to IK08
- Insulation class I
- Electrical connection via 5x1mm² H07RN-F cable
- Reflector made of metallised PC-HT or anodised and polished aluminium
- 4mm thick toughened front glass, silkscreen printed for symmetrical versions or with anti-reflective nanocoating for asymmetrical versions
- Equipped with a venting and anti-condensation valve
- It can be installed on the wall, ceiling or ground thanks to the galvanised steel bracket which is powder coated in polyester with trivalent passivation and equipped with an adjustable goniometric scale and supplied in kit form
- Anti-ageing silicone gaskets and A2 stainless steel exterior screws

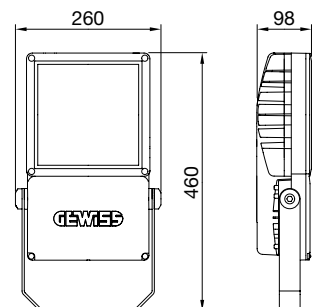

SMART [PRO]E
1M

Identifying and classifying our optics

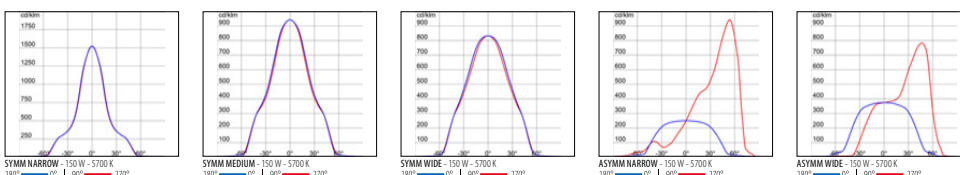

SMART IPROJE 1M SYMMETRIC

IP66 - IK08



LUMINAIRE WATTAGE (W)	CLASS	ENEC	CRI	KELVIN	OPTIC	BEAM ANGLE	LIGHTSOURCE LUMEN OUTPUT (lm)	LUMINAIRE LUMEN OUTPUT (lm)	COLOUR / FINISH	PART NUMBER	UKCA
Power LED dimmable 1-10 V 220-240 V 50/60 Hz											
150	I	✓	80	5700	SN	Narrow	-	21600	■	GWP2134CI857	✓
150	I	✓	80	5700	SM	Medium	-	21500	■	GWP2134CJ857	✓
150	I	✓	80	5700	SW	Wide	-	21500	■	GWP2134CK857	✓
150	I	✓	80	4000	SN	Narrow	-	21600	■	GWP2134CI840	✓
150	I	✓	80	4000	SM	Medium	-	21500	■	GWP2134CJ840	✓
150	I	✓	80	4000	SW	Wide	-	21500	■	GWP2134CK840	✓
150	I	✓	80	3000	SN	Narrow	-	21000	■	GWP2134CI830	✓
150	I	✓	80	3000	SM	Medium	-	20900	■	GWP2134CJ830	✓
150	I	✓	80	3000	SW	Wide	-	20900	■	GWP2134CK830	✓
150	I	✓	70	5700	SN	Narrow	-	22600	■	GWP2134CI757	✓
150	I	✓	70	5700	SM	Medium	-	22500	■	GWP2134CJ757	✓
150	I	✓	70	5700	SW	Wide	-	22500	■	GWP2134CK757	✓
150	I	✓	70	4000	SN	Narrow	-	22600	■	GWP2134CI740	✓
150	I	✓	70	4000	SM	Medium	-	22500	■	GWP2134CJ740	✓
150	I	✓	70	4000	SW	Wide	-	22500	■	GWP2134CK740	✓
150	I	✓	70	3000	SN	Narrow	-	22000	■	GWP2134CI730	✓
150	I	✓	70	3000	SM	Medium	-	21900	■	GWP2134CJ730	✓
150	I	✓	70	3000	SW	Wide	-	21900	■	GWP2134CK730	✓

SMART IPROJE 1M ASYMMETRIC

IP66 - IK08



LUMINAIRE WATTAGE (W)	CLASS	ENEC	CRI	KELVIN	OPTIC	BEAM ANGLE	LIGHTSOURCE LUMEN OUTPUT (lm)	LUMINAIRE LUMEN OUTPUT (lm)	COLOUR / FINISH	PART NUMBER	UKCA
Power LED dimmable 1-10 V 220-240 V 50/60 Hz											
150	I	✓	80	5700	ASW	Wide	-	21800	■	GWP2134CR857	✓
150	I	✓	80	5700	ALW	Medium	-	19500	■	GWP2134CX857	✓
150	I	✓	80	4000	ASW	Wide	-	21800	■	GWP2134CR840	✓
150	I	✓	80	4000	ALW	Medium	-	19500	■	GWP2134CX840	✓
150	I	✓	80	3000	ASW	Wide	-	21200	■	GWP2134CR830	✓
150	I	✓	80	3000	ALW	Medium	-	18900	■	GWP2134CX830	✓
150	I	✓	70	5700	ASW	Wide	-	22800	■	GWP2134CR757	✓
150	I	✓	70	5700	ALW	Medium	-	20400	■	GWP2134CX757	✓
150	I	✓	70	4000	ASW	Wide	-	22800	■	GWP2134CR740	✓
150	I	✓	70	4000	ALW	Medium	-	20400	■	GWP2134CX740	✓
150	I	✓	70	3000	ASW	Wide	-	22200	■	GWP2134CR730	✓
150	I	✓	70	3000	ALW	Medium	-	19800	■	GWP2134CX730	✓

Optional accessories

DESCRIPTION	COLOR	PART NUMBER	UKCA
SMART IPROJE 1M			
Visor		GWP20300	✓
Connector GW Connect 3 poles (for indoor use only)		GWP20110	✓
Connector GW Connect 4 poles (for indoor use only)		GWP20111	✓
Connector GW Connect 5 poles (for indoor use only)		GWP20112	✓
3-way connection kit		GWP20113	✓
4-way connection kit		GWP20114	✓
SMART IPROJE 1M /SYMM			
Replacement glass for symmetric optic versions		GWP20401	✓
SMART IPROJE 1M /ASYMM			
Replacement glass for asymmetric optic versions		GWP20403	✓

SMART [PRO]E 2M

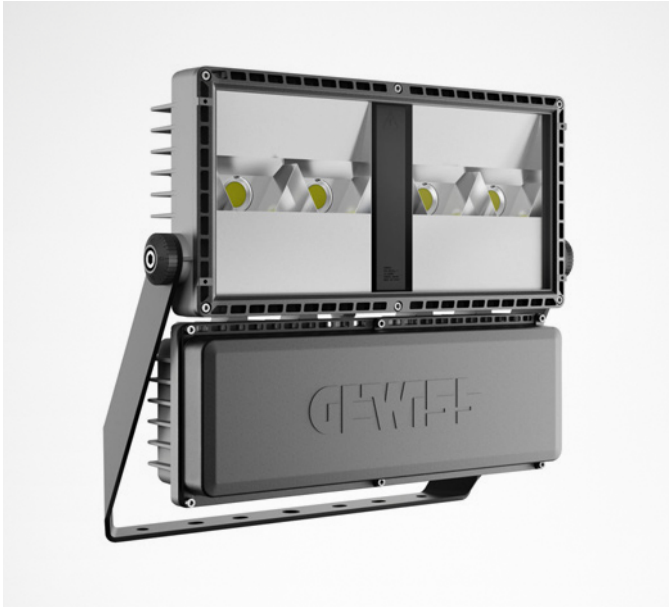

Scan the QR-code for the latest information

■ Graphite grey / Graphite grey /

Medium-power outdoor and indoor LED floodlight, ideal for lighting small to medium-sized areas and sports facilities

- The main body is made in die cast aluminium EN AB 46100, with an integrated passive heat sink, and powder coated polyester frame with trivalent passivation
- Available with five different types of optics, three types of Correlated Colour Temperature (3000K/4000K/5700K) and two different types of Colour Rendering Index (CRI70, CRI80)
- COB LED technology for high efficacy
- Built-in 1-10 V dimmable driver
- Designed to withstand surges up to 6 kV (differential mode) and 10 kV (common mode), temperature variations from -30°C to +50°C, water and dust penetration up to IP66, and impact up to IK08
- Insulation class I
- Electrical connection via 5x1mm² H07RN-F cable
- Reflector made of metallised PC-HT or anodised and polished aluminium
- 4mm thick toughened front glass, silkscreen printed for symmetrical versions or with anti-reflective nanocoating for asymmetrical versions
- Anti-ageing silicone gaskets and A2 stainless steel exterior screws
- Equipped with a venting and anti-condensation valve
- It can be installed on the wall, ceiling or ground thanks to the galvanised steel bracket which is powder coated in polyester with trivalent passivation and equipped with an adjustable goniometric scale and supplied in kit form

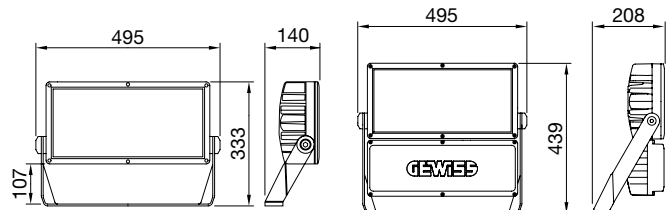

SMART [PRO]E
2M

SMART [PRO]E
2M RM

Identifying and classifying our optics

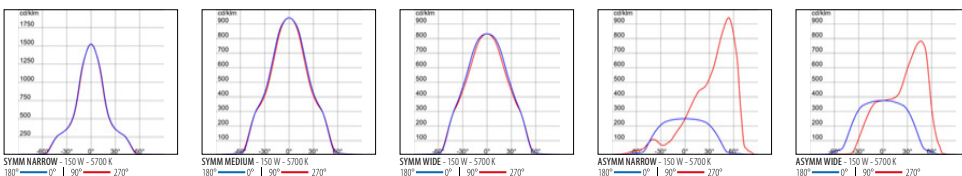

SMART IPROJE 2M RM SYMMETRIC

IP66 - IK08

LUMINAIRE WATTAGE (W)	CLASS	ENEC	CRI	KELVIN	OPTIC	BEAM ANGLE	LIGHTSOURCE LUMEN OUTPUT (lm)	LUMINAIRE LUMEN OUTPUT (lm)	COLOUR / FINISH	PART NUMBER	UKCA
Power LED - 1CH											
300	I	✓	80	5700	SN	Narrow	-	43200	■	GWP2234AI857	✓
300	I	✓	80	5700	SM	Medium	-	43000	■	GWP2234AJ857	✓
300	I	✓	80	5700	SW	Wide	-	43000	■	GWP2234AK857	✓
300	I	✓	80	4000	SN	Narrow	-	43200	■	GWP2234AI840	✓
300	I	✓	80	4000	SM	Medium	-	43000	■	GWP2234AJ840	✓
300	I	✓	80	4000	SW	Wide	-	43000	■	GWP2234AK840	✓
300	I	✓	80	3000	SN	Narrow	-	42000	■	GWP2234AI830	✓
300	I	✓	80	3000	SM	Medium	-	41800	■	GWP2234AJ830	✓
300	I	✓	80	3000	SW	Wide	-	41800	■	GWP2234AK830	✓
300	I	✓	70	5700	SN	Narrow	-	45200	■	GWP2234AI757	✓
300	I	✓	70	5700	SM	Medium	-	45000	■	GWP2234AJ757	✓
300	I	✓	70	5700	SW	Wide	-	45000	■	GWP2234AK757	✓
300	I	✓	70	4000	SN	Narrow	-	45200	■	GWP2234AI740	✓
300	I	✓	70	4000	SM	Medium	-	45000	■	GWP2234AJ740	✓
300	I	✓	70	4000	SW	Wide	-	45000	■	GWP2234AK740	✓
300	I	✓	70	3000	SN	Narrow	-	44000	■	GWP2234AI730	✓
300	I	✓	70	3000	SM	Medium	-	43800	■	GWP2234AJ730	✓
300	I	✓	70	3000	SW	Wide	-	43800	■	GWP2234AK730	✓



SMART IPROJE 2M RM ASYMMETRIC

IP66 - IK08

LUMINAIRE WATTAGE (W)	CLASS	ENEC	CRI	KELVIN	OPTIC	BEAM ANGLE	LIGHTSOURCE LUMEN OUTPUT (lm)	LUMINAIRE LUMEN OUTPUT (lm)	COLOUR / FINISH	PART NUMBER	UKCA
Power LED - 1CH											
300	I	✓	80	5700	ASW	Wide	-	43600	■	GWP2234AR857	✓
300	I	✓	80	5700	ALW	Medium	-	39000	■	GWP2234AX857	✓
300	I	✓	80	4000	ASW	Wide	-	43600	■	GWP2234AR840	✓
300	I	✓	80	4000	ALW	Medium	-	39000	■	GWP2234AX840	✓
300	I	✓	80	3000	ASW	Wide	-	42400	■	GWP2234AR830	✓
300	I	✓	80	3000	ALW	Medium	-	37800	■	GWP2234AX830	✓
300	I	✓	70	5700	ASW	Wide	-	45600	■	GWP2234AR757	✓
300	I	✓	70	5700	ALW	Medium	-	40800	■	GWP2234AX757	✓
300	I	✓	70	4000	ASW	Wide	-	45600	■	GWP2234AR740	✓
300	I	✓	70	4000	ALW	Medium	-	40800	■	GWP2234AX740	✓
300	I	✓	70	3000	ASW	Wide	-	44400	■	GWP2234AR730	✓
300	I	✓	70	3000	ALW	Medium	-	39600	■	GWP2234AX730	✓



SMART IPROJE 2M SYMMETRIC

IP66 - IK08

LUMINAIRE WATTAGE (W)	CLASS	ENEC	CRI	KELVIN	OPTIC	BEAM ANGLE	LIGHTSOURCE LUMEN OUTPUT (lm)	LUMINAIRE LUMEN OUTPUT (lm)	COLOUR / FINISH	PART NUMBER	UKCA
Power LED dimmable 1-10 V 220-240 V 50/60 Hz											
300	I	✓	80	5700	SN	Narrow	-	43200	■	GWP2234CI857	✓
300	I	✓	80	5700	SM	Medium	-	43000	■	GWP2234CJ857	✓
300	I	✓	80	5700	SW	Wide	-	43000	■	GWP2234CK857	✓
300	I	✓	80	4000	SN	Narrow	-	43200	■	GWP2234CI840	✓
300	I	✓	80	4000	SM	Medium	-	43000	■	GWP2234CJ840	✓
300	I	✓	80	4000	SW	Wide	-	43000	■	GWP2234CK840	✓
300	I	✓	80	3000	SN	Narrow	-	42000	■	GWP2234CI830	✓
300	I	✓	80	3000	SM	Medium	-	41800	■	GWP2234CJ830	✓
300	I	✓	80	3000	SW	Wide	-	41800	■	GWP2234CK830	✓
300	I	✓	70	5700	SN	Narrow	-	45200	■	GWP2234CI757	✓
300	I	✓	70	5700	SM	Medium	-	45000	■	GWP2234CJ757	✓
300	I	✓	70	5700	SW	Wide	-	45000	■	GWP2234CK757	✓
300	I	✓	70	4000	SN	Narrow	-	45200	■	GWP2234CI740	✓
300	I	✓	70	4000	SM	Medium	-	45000	■	GWP2234CJ740	✓
300	I	✓	70	4000	SW	Wide	-	45000	■	GWP2234CK740	✓
300	I	✓	70	3000	SN	Narrow	-	44000	■	GWP2234CI730	✓
300	I	✓	70	3000	SM	Medium	-	43800	■	GWP2234CJ730	✓
300	I	✓	70	3000	SW	Wide	-	43800	■	GWP2234CK730	✓



Sports and Area

SMART [PROJE 2M ASYMMETRIC

IP66 - IK08

LUMINAIRE WATTAGE (W)	CLASS	ENEC	CRI	KELVIN	OPTIC	BEAM ANGLE	LIGHTSOURCE LUMEN OUTPUT (lm)	LUMINAIRE LUMEN OUTPUT (lm)	COLOUR / FINISH	PART NUMBER	UKCA
Power LED dimmable 1-10 V 220-240 V 50/60 Hz											
300	I	✓	80	5700	ASW	Wide	-	43600	■	GWP2234CR857	✓
300	I	✓	80	5700	ALW	Medium	-	39000	■	GWP2234CX857	✓
300	I	✓	80	4000	ASW	Wide	-	43600	■	GWP2234CR840	✓
300	I	✓	80	4000	ALW	Medium	-	39000	■	GWP2234CX840	✓
300	I	✓	80	3000	ASW	Wide	-	42400	■	GWP2234CR830	✓
300	I	✓	80	3000	ALW	Medium	-	37800	■	GWP2234CX830	✓
300	I	✓	70	5700	ASW	Wide	-	45600	■	GWP2234CR757	✓
300	I	✓	70	5700	ALW	Medium	-	40800	■	GWP2234CX757	✓
300	I	✓	70	4000	ASW	Wide	-	45600	■	GWP2234CR740	✓
300	I	✓	70	4000	ALW	Medium	-	40800	■	GWP2234CX740	✓
300	I	✓	70	3000	ASW	Wide	-	44400	■	GWP2234CR730	✓
300	I	✓	70	3000	ALW	Medium	-	39600	■	GWP2234CX730	✓



Control gear

DESCRIPTION	COLOR	PART NUMBER	UKCA
SMART [PROJE 2M RM			
Power supply unit 1-10 V 220-240 V		GWP20010	✓

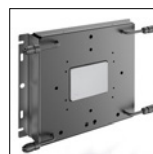

GWP20010

Optional accessories

DESCRIPTION	COLOR	PART NUMBER	UKCA
SMART [PROJE 2M			
Visor		GWP20301	✓
Connector GW Connect 3 poles (for indoor use only)		GWP20110	✓
Connector GW Connect 4 poles (for indoor use only)		GWP20111	✓
Connector GW Connect 5 poles (for indoor use only)		GWP20112	✓
3-way connection kit		GWP20113	✓
4-way connection kit		GWP20114	✓
SMART [PROJE 2M /SYMM			
Replacement glass for symmetric optic versions		GWP20402	✓
SMART [PROJE 2M /ASYMM			
Replacement glass for asymmetric optic versions		GWP20404	✓

SMART [PRO]E 4M



Scan the QR-code for the latest information

■ Graphite grey / Graphite grey /

High-power outdoor and indoor LED floodlight, ideal for lighting medium-sized areas and sports facilities

- The main body is made in die cast aluminium EN AB 46100, with an integrated passive heat sink, and powder coated polyester frame with trivalent passivation
- Available with five different types of optics, three types of Correlated Colour Temperature (3000K/4000K/5700K) and two different types of Colour Rendering Index (CRI70, CRI80)
- COB LED technology for high efficacy
- Power supply unit and IP68 connector kit supplied separately
- Designed to withstand surges up to 6 kV (differential mode) and 10 kV (common mode), temperature variations from -30°C to +50°C, water and dust penetration up to IP66, and impact up to IK08
- Insulation class I
- Electrical connection via 5x1mm² H07RN-F cable
- Reflector made of metallised PC-HT or anodised and polished aluminium
- 4mm thick toughened front glass, silkscreen printed for symmetrical versions or with anti-reflective nanocoating for asymmetrical versions
- Anti-ageing silicone gaskets and A2 stainless steel exterior screws
- Plastic venting and anti-condensation device
- It can be installed on the wall, ceiling or ground thanks to the galvanised steel bracket which is powder coated in polyester with trivalent passivation and equipped with an adjustable goniometric scale and supplied in kit form

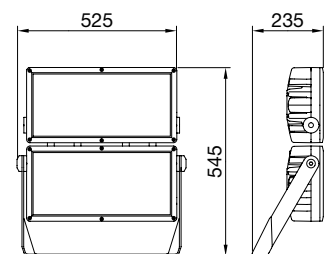

SMART [PRO]E
4M

Identifying and classifying our optics

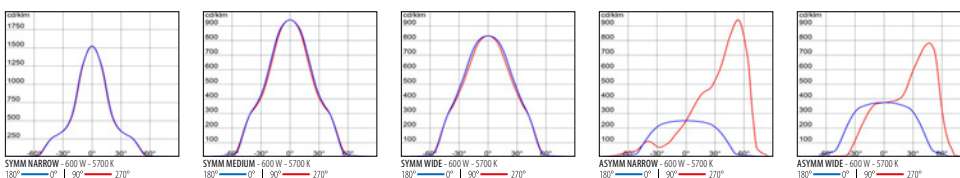

SMART IPROJE 4M SYMMETRIC

IP66 - IK08

LUMINAIRE WATTAGE (W)	CLASS	ENEC	CRI	KELVIN	OPTIC	BEAM ANGLE	LIGHTSOURCE LUMEN OUTPUT (lm)	LUMINAIRE LUMEN OUTPUT (lm)	COLOUR / FINISH	PART NUMBER	UKCA
Power LED - 2CH											
600	I	✓	80	5700	SN	Narrow	-	86400	■	GWP2434AI857	✓
600	I	✓	80	5700	SM	Medium	-	86000	■	GWP2434AJ857	✓
600	I	✓	80	5700	SW	Wide	-	86000	■	GWP2434AK857	✓
600	I	✓	80	4000	SN	Narrow	-	86400	■	GWP2434AI840	✓
600	I	✓	80	4000	SM	Medium	-	86000	■	GWP2434AJ840	✓
600	I	✓	80	4000	SW	Wide	-	86000	■	GWP2434AK840	✓
600	I	✓	80	3000	SN	Narrow	-	84000	■	GWP2434AI830	✓
600	I	✓	80	3000	SM	Medium	-	83600	■	GWP2434AJ830	✓
600	I	✓	80	3000	SW	Wide	-	83600	■	GWP2434AK830	✓
600	I	✓	70	5700	SN	Narrow	-	90400	■	GWP2434AI757	✓
600	I	✓	70	5700	SM	Medium	-	90000	■	GWP2434AJ757	✓
600	I	✓	70	5700	SW	Wide	-	90000	■	GWP2434AK757	✓
600	I	✓	70	4000	SN	Narrow	-	90400	■	GWP2434AI740	✓
600	I	✓	70	4000	SM	Medium	-	90000	■	GWP2434AJ740	✓
600	I	✓	70	4000	SW	Wide	-	90000	■	GWP2434AK740	✓
600	I	✓	70	3000	SN	Narrow	-	88000	■	GWP2434AI730	✓
600	I	✓	70	3000	SM	Medium	-	87600	■	GWP2434AJ730	✓
600	I	✓	70	3000	SW	Wide	-	87600	■	GWP2434AK730	✓



SMART IPROJE 4M ASYMMETRIC

IP66 - IK08

LUMINAIRE WATTAGE (W)	CLASS	ENEC	CRI	KELVIN	OPTIC	BEAM ANGLE	LIGHTSOURCE LUMEN OUTPUT (lm)	LUMINAIRE LUMEN OUTPUT (lm)	COLOUR / FINISH	PART NUMBER	UKCA
Power LED - 2CH											
600	I	✓	80	5700	ASW	Wide	-	87200	■	GWP2434AR857	✓
600	I	✓	80	5700	ALW	Medium	-	78000	■	GWP2434AX857	✓
600	I	✓	80	4000	ASW	Wide	-	87200	■	GWP2434AR840	✓
600	I	✓	80	4000	ALW	Medium	-	78000	■	GWP2434AX840	✓
600	I	✓	80	3000	ASW	Wide	-	84800	■	GWP2434AR830	✓
600	I	✓	80	3000	ALW	Medium	-	75600	■	GWP2434AX830	✓
600	I	✓	70	5700	ASW	Wide	-	91200	■	GWP2434AR757	✓
600	I	✓	70	5700	ALW	Medium	-	81600	■	GWP2434AX757	✓
600	I	✓	70	4000	ASW	Wide	-	91200	■	GWP2434AR740	✓
600	I	✓	70	4000	ALW	Medium	-	81600	■	GWP2434AX740	✓
600	I	✓	70	3000	ASW	Wide	-	88800	■	GWP2434AR730	✓
600	I	✓	70	3000	ALW	Medium	-	79200	■	GWP2434AX730	✓



Control gear

DESCRIPTION	COLOR	PART NUMBER	UKCA
SMART [PROJE 4M			
Power supply unit 1-10 V 220-240 V		GWP20011	✓

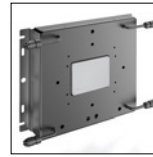

GWP20011

Optional accessories

DESCRIPTION	COLOR	PART NUMBER	UKCA
SMART [PROJE 4M			
Visor		GWP20301	✓
Connector GW Connect 3 poles (for indoor use only)		GWP20110	✓
Connector GW Connect 4 poles (for indoor use only)		GWP20111	✓
Connector GW Connect 5 poles (for indoor use only)		GWP20112	✓
3-way connection kit		GWP20113	✓
4-way connection kit		GWP20114	✓
SMART [PROJE 4M /SYMM			
Replacement glass for symmetric optic versions		GWP20402	✓
SMART [PROJE 4M - ASYMM			
Replacement glass for asymmetric optic versions		GWP20404	✓

SMART [PRO] 2.0 1M

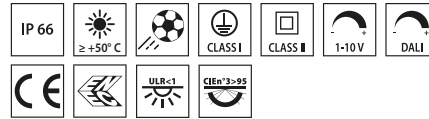

Scan the QR-code for the latest information

■ Graphite grey / Graphite grey /

Medium power outdoor and indoor LED projector, suitable for lighting sports areas and facilities

- The body is produced in aluminium die casting EN AB 46100, with integrated passive heat sink, powder coated polyester with trivalent passivation
- Available with nine different types of optics, three types of Colour Temperature (3,000K/4,000K/5,700K) and two different types of Chromatic Yield Index (CRI>70, CRI>80)
- Metal core PCB with CSP LED
- Available with integrated 1-10V or DALI driver
- Designed to withstand surges up to 5 kV (RCCB mode) and 10 kV (common mode), temperature variations from -30°C to +50°C, water and dust penetration up to IP66 protection and impacts up to IK08
- Insulation class I or II
- Electrical connection via IP68 connector for 1.5mm² cables
- Reflector made of metallic HT PC or anodised and polished aluminium
- Hardened front glass with 4mm thickness, anti-ageing silicone seals and A2 stainless steel exterior screws
- Equipped with a venting and anti-condensation valve
- It can be installed on the wall, ceiling or ground thanks to the polyester powder coated galvanised steel bracket, with trivalent passivation, equipped with adjustable goniometric scale and supplied in kit



Monte Bondone - Trento - Italy

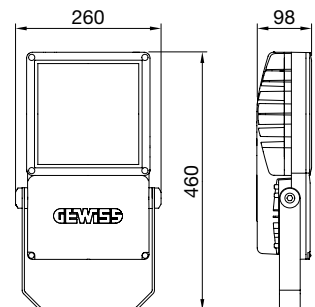

SMART [PRO] 2.0
1M

Identifying and classifying our optics

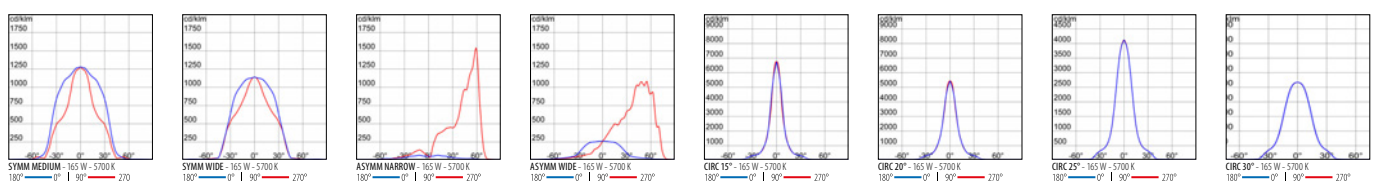

SMART [PRO] 2.0 1M SYMMETRIC

IP66 - IK08



LUMINAIRE WATTAGE (W)	CLASS	ENEC	CRI	KELVIN	OPTIC	BEAM ANGLE	LIGHTSOURCE LUMEN OUTPUT (lm)	LUMINAIRE LUMEN OUTPUT (lm)	COLOUR / FINISH	PART NUMBER	UKCA
Power LED dimmable 1-10 V 220-240 V 50/60 Hz											
165	I	✓	80	5700	S1	Wide	-	19200	■	GWP2185AS	✓
165	I	✓	80	5700	S2	Medium	-	19900	■	GWP2185BS	✓
165	I	✓	80	4000	S1	Wide	-	19200	■	GWP2184AS	✓
165	I	✓	80	4000	S2	Medium	-	19900	■	GWP2184BS	✓
165	I	✓	70	5700	S1	Wide	-	20600	■	GWP2175AS	✓
165	I	✓	70	5700	S2	Medium	-	21300	■	GWP2175BS	✓
165	I	✓	70	4000	S1	Wide	-	20600	■	GWP2174AS	✓
165	I	✓	70	4000	S2	Medium	-	21300	■	GWP2174BS	✓
165	I	✓	70	3000	S1	Wide	-	19200	■	GWP2173AS	✓
165	I	✓	70	3000	S2	Medium	-	19900	■	GWP2173BS	✓
Power LED dimmable DALI - 220-240 V 50/60 Hz											
165	II	✓	80	4000	S1	Wide	-	19200	■	GWP2184AB	✓
165	II	✓	80	4000	S2	Medium	-	19900	■	GWP2184BB	✓
165	II	✓	80	3000	S1	Wide	-	17900	■	GWP2183AB	✓
165	II	✓	80	3000	S2	Medium	-	18500	■	GWP2183BB	✓
165	II	✓	70	5700	S1	Wide	-	20600	■	GWP2175AB	✓
165	II	✓	70	5700	S2	Medium	-	21300	■	GWP2175BB	✓
165	II	✓	70	4000	S1	Wide	-	20600	■	GWP2174AB	✓
165	II	✓	70	4000	S2	Medium	-	21300	■	GWP2174BB	✓
165	II	✓	70	3000	S1	Wide	-	19200	■	GWP2173AB	✓
165	II	✓	70	3000	S2	Medium	-	19900	■	GWP2173BB	✓
165	I	✓	80	5700	S1	Wide	-	19200	■	GWP2185AD	✓
165	I	✓	80	5700	S2	Medium	-	19900	■	GWP2185BD	✓
165	I	✓	80	4000	S1	Wide	-	19200	■	GWP2184AD	✓
165	I	✓	80	4000	S2	Medium	-	19900	■	GWP2184BD	✓
165	I	✓	70	5700	S1	Wide	-	20600	■	GWP2175AD	✓
165	I	✓	70	5700	S2	Medium	-	21300	■	GWP2175BD	✓
165	I	✓	70	4000	S1	Wide	-	20600	■	GWP2174AD	✓
165	I	✓	70	4000	S2	Medium	-	21300	■	GWP2174BD	✓
165	I	✓	70	3000	S1	Wide	-	19200	■	GWP2173AD	✓
165	I	✓	70	3000	S2	Medium	-	19900	■	GWP2173BD	✓

SMART [PRO] 2.0 1M ASYMMETRIC

IP66 - IK08

LUMINAIRE WATTAGE [W]	CLASS	ENEC	CRI	KELVIN	OPTIC	BEAM ANGLE	LIGHTSOURCE LUMEN OUTPUT [lm]	LUMINAIRE LUMEN OUTPUT [lm]	COLOUR / FINISH	PART NUMBER	UKCA
Power LED dimmable 1-10 V 220-240 V 50/60 Hz											
165	I	✓	80	5700	A1	Wide	-	18300	■	GWP2185CS	✓
165	I	✓	80	5700	A3	Narrow	-	20700	■	GWP2185NS	✓
165	I	✓	80	4000	A1	Wide	-	18300	■	GWP2184CS	✓
165	I	✓	80	4000	A3	Narrow	-	20700	■	GWP2184NS	✓
165	I	✓	70	5700	A1	Wide	-	19600	■	GWP2175CS	✓
165	I	✓	70	5700	A3	Narrow	-	22100	■	GWP2175NS	✓
165	I	✓	70	4000	A1	Wide	-	19600	■	GWP2174CS	✓
165	I	✓	70	4000	A3	Narrow	-	22100	■	GWP2174NS	✓
165	I	✓	70	3000	A1	Wide	-	18300	■	GWP2173CS	✓
165	I	✓	70	3000	A3	Narrow	-	20700	■	GWP2173NS	✓
Power LED dimmable DALI - 220-240 V 50/60 Hz											
165	II	✓	80	4000	A1	Wide	-	18300	■	GWP2184CB	✓
165	II	✓	80	4000	A3	Narrow	-	20700	■	GWP2184NB	✓
165	II	✓	80	3000	A1	Wide	-	17000	■	GWP2183CB	✓
165	II	✓	80	3000	A3	Narrow	-	19200	■	GWP2183NB	✓
165	II	✓	70	5700	A1	Wide	-	19600	■	GWP2175CB	✓
165	II	✓	70	5700	A3	Narrow	-	22100	■	GWP2175NB	✓
165	II	✓	70	4000	A1	Wide	-	19600	■	GWP2174CB	✓
165	II	✓	70	4000	A3	Narrow	-	22100	■	GWP2174NB	✓
165	II	✓	70	3000	A1	Wide	-	18300	■	GWP2173CB	✓
165	II	✓	70	3000	A3	Narrow	-	20700	■	GWP2173NB	✓
165	I	✓	80	5700	A1	Wide	-	18300	■	GWP2185CD	✓
165	I	✓	80	5700	A3	Narrow	-	20700	■	GWP2185ND	✓
165	I	✓	80	4000	A1	Wide	-	18300	■	GWP2184CD	✓
165	I	✓	80	4000	A3	Narrow	-	20700	■	GWP2184ND	✓
165	I	✓	70	5700	A1	Wide	-	19600	■	GWP2175CD	✓
165	I	✓	70	5700	A3	Narrow	-	22100	■	GWP2175ND	✓
165	I	✓	70	4000	A1	Wide	-	19600	■	GWP2174CD	✓
165	I	✓	70	4000	A3	Narrow	-	22100	■	GWP2174ND	✓
165	I	✓	70	3000	A1	Wide	-	18300	■	GWP2173CD	✓
165	I	✓	70	3000	A3	Narrow	-	20700	■	GWP2173ND	✓



SMART [PRO] 2.0 1M CIRCULAR

IP66 - IK08

LUMINAIRE WATTAGE [W]	CLASS	ENEC	CRI	KELVIN	OPTIC	BEAM ANGLE	LIGHTSOURCE LUMEN OUTPUT [lm]	LUMINAIRE LUMEN OUTPUT [lm]	COLOUR / FINISH	PART NUMBER	UKCA
Power LED dimmable 1-10 V 220-240 V 50/60 Hz											
165	I	✓	80	5700	C4	15°	-	19600	■	GWP2185GS	✓
165	I	✓	80	5700	C3	20°	-	19600	■	GWP2185HS	✓
165	I	✓	80	5700	C2	25°	-	19200	■	GWP2185LS	✓
165	I	✓	80	5700	C1	30°	-	19000	■	GWP2185MS	✓
165	I	✓	80	4000	C4	15°	-	19600	■	GWP2184GS	✓
165	I	✓	80	4000	C3	20°	-	19600	■	GWP2184HS	✓
165	I	✓	80	4000	C2	25°	-	19200	■	GWP2184LS	✓
165	I	✓	80	4000	C1	30°	-	19000	■	GWP2184MS	✓
165	I	✓	70	5700	C4	15°	-	21000	■	GWP2175GS	✓
165	I	✓	70	5700	C3	20°	-	21000	■	GWP2175HS	✓
165	I	✓	70	5700	C2	25°	-	20500	■	GWP2175LS	✓
165	I	✓	70	5700	C1	30°	-	20400	■	GWP2175MS	✓
165	I	✓	70	4000	C4	15°	-	21000	■	GWP2174GS	✓
165	I	✓	70	4000	C3	20°	-	21000	■	GWP2174HS	✓
165	I	✓	70	4000	C2	25°	-	20500	■	GWP2174LS	✓
165	I	✓	70	4000	C1	30°	-	20400	■	GWP2174MS	✓
165	I	✓	70	3000	C4	15°	-	19600	■	GWP2173GS	✓
165	I	✓	70	3000	C3	20°	-	19600	■	GWP2173HS	✓
165	I	✓	70	3000	C2	25°	-	19200	■	GWP2173LS	✓
165	I	✓	70	3000	C1	30°	-	19000	■	GWP2173MS	✓



Power LED dimmable DALI - 220-240 V 50/60 Hz

165	II	✓	80	4000	C4	15°	-	19600	■	GWP2184GB	✓
165	II	✓	80	4000	C3	20°	-	19600	■	GWP2184HB	✓
165	II	✓	80	4000	C2	25°	-	19200	■	GWP2184LB	✓
165	II	✓	80	4000	C1	30°	-	19000	■	GWP2184MB	✓
165	II	✓	80	3000	C4	15°	-	18200	■	GWP2183GB	✓
165	II	✓	80	3000	C3	20°	-	18200	■	GWP2183HB	✓
165	II	✓	80	3000	C2	25°	-	17800	■	GWP2183LB	✓
165	II	✓	80	3000	C1	30°	-	17600	■	GWP2183MB	✓
165	II	✓	70	5700	C4	15°	-	21000	■	GWP2175GB	✓
165	II	✓	70	5700	C3	20°	-	21000	■	GWP2175HB	✓
165	II	✓	70	5700	C2	25°	-	20500	■	GWP2175LB	✓
165	II	✓	70	5700	C1	30°	-	20400	■	GWP2175MB	✓
165	II	✓	70	4000	C4	15°	-	21000	■	GWP2174GB	✓
165	II	✓	70	4000	C3	20°	-	21000	■	GWP2174HB	✓
165	II	✓	70	4000	C2	25°	-	20500	■	GWP2174LB	✓
165	II	✓	70	4000	C1	30°	-	20400	■	GWP2174MB	✓
165	II	✓	70	3000	C4	15°	-	19600	■	GWP2173GB	✓
165	II	✓	70	3000	C3	20°	-	19600	■	GWP2173HB	✓
165	II	✓	70	3000	C2	25°	-	19200	■	GWP2173LB	✓
165	II	✓	70	3000	C1	30°	-	19000	■	GWP2173MB	✓
165	I	✓	80	5700	C4	15°	-	19600	■	GWP2185GD	✓
165	I	✓	80	5700	C3	20°	-	19600	■	GWP2185HD	✓
165	I	✓	80	5700	C2	25°	-	19200	■	GWP2185LD	✓
165	I	✓	80	5700	C1	30°	-	19000	■	GWP2185MD	✓
165	I	✓	80	4000	C4	15°	-	19600	■	GWP2184GD	✓
165	I	✓	80	4000	C3	20°	-	19600	■	GWP2184HD	✓
165	I	✓	80	4000	C2	25°	-	19200	■	GWP2184LD	✓
165	I	✓	80	4000	C1	30°	-	19000	■	GWP2184MD	✓
165	I	✓	70	5700	C4	15°	-	21000	■	GWP2175GD	✓
165	I	✓	70	5700	C3	20°	-	21000	■	GWP2175HD	✓
165	I	✓	70	5700	C2	25°	-	20500	■	GWP2175LD	✓
165	I	✓	70	5700	C1	30°	-	20400	■	GWP2175MD	✓
165	I	✓	70	4000	C4	15°	-	21000	■	GWP2174GD	✓
165	I	✓	70	4000	C3	20°	-	21000	■	GWP2174HD	✓
165	I	✓	70	4000	C2	25°	-	20500	■	GWP2174LD	✓
165	I	✓	70	4000	C1	30°	-	20400	■	GWP2174MD	✓
165	I	✓	70	3000	C4	15°	-	19600	■	GWP2173GD	✓
165	I	✓	70	3000	C3	20°	-	19600	■	GWP2173HD	✓
165	I	✓	70	3000	C2	25°	-	19200	■	GWP2173LD	✓
165	I	✓	70	3000	C1	30°	-	19000	■	GWP2173MD	✓

Optional accessories

DESCRIPTION	COLOR	PART NUMBER	UKCA
SMART [PRO] 2.0 1M			
Connector GW Connect 3 poles (for indoor use only)		GWP20110	✓
Connector GW Connect 4 poles (for indoor use only)		GWP20111	✓
Connector GW Connect 5 poles (for indoor use only)		GWP20112	✓
3-way connection kit		GWP20113	✓
4-way connection kit		GWP20114	✓

SMART [PRO] 2.0 2M



■ Graphite grey / Graphite grey /

Scan the QR-code for the latest information

Medium power outdoor and indoor LED projector, suitable for lighting sports areas and facilities

- The body is produced in aluminium die casting EN AB 46100, with integrated passive heat sink, powder coated polyester with trivalent passivation
- Available with nine different types of optics, three types of Colour Temperature (3,000K/4,000K/5,700K) and two different types of Chromatic Yield Index (CRI>70, CRI>80)
- Metal core PCB with CSP LED
- Available with integrated 1-10V or DALI driver
- Designed to withstand surges up to 5 kV (RCCB mode) and 10 kV (common mode), temperature variations from -30°C to +50°C, water and dust penetration up to IP66 protection and impacts up to IK08
- Insulation class I or II
- Electrical connection via IP68 connector for 1.5mm² cables
- Reflector made of metallic HT PC or anodised and polished aluminium
- Hardened front glass with 4mm thickness, anti-ageing silicone seals and A2 stainless steel exterior screws
- Equipped with a venting and anti-condensation valve
- It can be installed on the wall, ceiling or ground thanks to the polyester powder coated galvanised steel bracket, with trivalent passivation, equipped with adjustable goniometric scale and supplied in kit



BMX Olympic - Verona - Italy

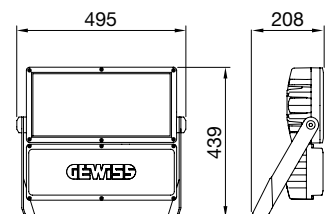

SMART [PRO] 2.0
2M

Identifying and classifying our optics

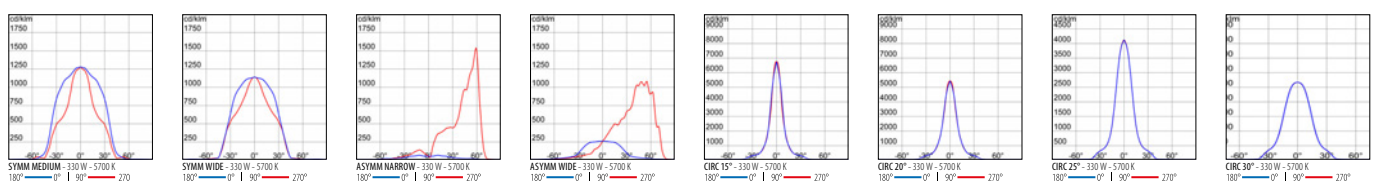

SMART [PRO] 2.0 2M SYMMETRIC

IP66 - IK08



LUMINAIRE WATTAGE (W)	CLASS	ENEC	CRI	KELVIN	OPTIC	BEAM ANGLE	LIGHTSOURCE LUMEN OUTPUT (lm)	LUMINAIRE LUMEN OUTPUT (lm)	COLOUR / FINISH	PART NUMBER	UKCA
Power LED dimmable 1-10 V 220-240 V 50/60 Hz											
330	I	✓	80	5700	S1	Wide	-	38500	■	GWP2285AS	✓
330	I	✓	80	5700	S2	Medium	-	39800	■	GWP2285BS	✓
330	I	✓	80	4000	S1	Wide	-	38500	■	GWP2284AS	✓
330	I	✓	80	4000	S2	Medium	-	39800	■	GWP2284BS	✓
330	I	✓	70	5700	S1	Wide	-	41200	■	GWP2275AS	✓
330	I	✓	70	5700	S2	Medium	-	42700	■	GWP2275BS	✓
330	I	✓	70	4000	S1	Wide	-	41200	■	GWP2274AS	✓
330	I	✓	70	4000	S2	Medium	-	42700	■	GWP2274BS	✓
330	I	✓	70	3000	S1	Wide	-	38500	■	GWP2273AS	✓
330	I	✓	70	3000	S2	Medium	-	39800	■	GWP2273BS	✓
Power LED dimmable DALI - 220-240 V 50/60 Hz											
330	II	✓	80	4000	S1	Wide	-	38500	■	GWP2284AB	✓
330	II	✓	80	4000	S2	Medium	-	39800	■	GWP2284BB	✓
330	II	✓	80	3000	S1	Wide	-	35700	■	GWP2283AB	✓
330	II	✓	80	3000	S2	Medium	-	37000	■	GWP2283BB	✓
330	II	✓	70	5700	S1	Wide	-	41200	■	GWP2275AB	✓
330	II	✓	70	5700	S2	Medium	-	42700	■	GWP2275BB	✓
330	II	✓	70	4000	S1	Wide	-	41200	■	GWP2274AB	✓
330	II	✓	70	4000	S2	Medium	-	42700	■	GWP2274BB	✓
330	II	✓	70	3000	S1	Wide	-	38500	■	GWP2273AB	✓
330	II	✓	70	3000	S2	Medium	-	39800	■	GWP2273BB	✓
330	I	✓	80	5700	S1	Wide	-	38500	■	GWP2285AD	✓
330	I	✓	80	5700	S2	Medium	-	39800	■	GWP2285BD	✓
330	I	✓	80	4000	S1	Wide	-	38500	■	GWP2284AD	✓
330	I	✓	80	4000	S2	Medium	-	39800	■	GWP2284BD	✓
330	I	✓	70	5700	S1	Wide	-	41200	■	GWP2275AD	✓
330	I	✓	70	5700	S2	Medium	-	42700	■	GWP2275BD	✓
330	I	✓	70	4000	S1	Wide	-	41200	■	GWP2274AD	✓
330	I	✓	70	4000	S2	Medium	-	42700	■	GWP2274BD	✓
330	I	✓	70	3000	S1	Wide	-	38500	■	GWP2273AD	✓
330	I	✓	70	3000	S2	Medium	-	39800	■	GWP2273BD	✓

SMART [PRO] 2.0 2M ASYMMETRIC

IP66 - IK08

LUMINAIRE WATTAGE [W]	CLASS	ENEC	CRI	KELVIN	OPTIC	BEAM ANGLE	LIGHTSOURCE LUMEN OUTPUT [lm]	LUMINAIRE LUMEN OUTPUT [lm]	COLOUR / FINISH	PART NUMBER	UKCA
Power LED dimmable 1-10 V 220-240 V 50/60 Hz											
330	I	✓	80	5700	A1	Wide	-	36600	■	GWP2285CS	✓
330	I	✓	80	5700	A3	Narrow	-	41300	■	GWP2285NS	✓
330	I	✓	80	4000	A1	Wide	-	36900	■	GWP2284CS	✓
330	I	✓	80	4000	A3	Narrow	-	41300	■	GWP2284NS	✓
330	I	✓	70	5700	A1	Wide	-	39200	■	GWP2275CS	✓
330	I	✓	70	5700	A3	Narrow	-	44300	■	GWP2275NS	✓
330	I	✓	70	4000	A1	Wide	-	39200	■	GWP2274CS	✓
330	I	✓	70	4000	A3	Narrow	-	44300	■	GWP2274NS	✓
330	I	✓	70	3000	A1	Wide	-	36600	■	GWP2273CS	✓
330	I	✓	70	3000	A3	Narrow	-	41300	■	GWP2273NS	✓
Power LED dimmable DALI - 220-240 V 50/60 Hz											
330	II	✓	80	4000	A1	Wide	-	39600	■	GWP2284CB	✓
330	II	✓	80	4000	A3	Narrow	-	41300	■	GWP2284NB	✓
330	II	✓	80	3000	A1	Wide	-	34000	■	GWP2283CB	✓
330	II	✓	80	3000	A3	Narrow	-	38400	■	GWP2283NB	✓
330	II	✓	70	5700	A1	Wide	-	39200	■	GWP2275CB	✓
330	II	✓	70	5700	A3	Narrow	-	44300	■	GWP2275NB	✓
330	II	✓	70	4000	A1	Wide	-	39200	■	GWP2274CB	✓
330	II	✓	70	4000	A3	Narrow	-	44300	■	GWP2274NB	✓
330	II	✓	70	3000	A1	Wide	-	36600	■	GWP2273CB	✓
330	II	✓	70	3000	A3	Narrow	-	41300	■	GWP2273NB	✓
330	I	✓	80	5700	A1	Wide	-	36600	■	GWP2285CD	✓
330	I	✓	80	5700	A3	Narrow	-	41300	■	GWP2285ND	✓
330	I	✓	80	4000	A1	Wide	-	36600	■	GWP2284CD	✓
330	I	✓	80	4000	A3	Narrow	-	41300	■	GWP2284ND	✓
330	I	✓	70	5700	A1	Wide	-	39200	■	GWP2275CD	✓
330	I	✓	70	5700	A3	Narrow	-	44300	■	GWP2275ND	✓
330	I	✓	70	4000	A1	Wide	-	39200	■	GWP2274CD	✓
330	I	✓	70	4000	A3	Narrow	-	44300	■	GWP2274ND	✓
330	I	✓	70	3000	A1	Wide	-	36600	■	GWP2273CD	✓
330	I	✓	70	3000	A3	Narrow	-	41300	■	GWP2273ND	✓



SMART [PRO] 2.0 2M CIRCULAR

IP66 - IK08

LUMINAIRE WATTAGE [W]	CLASS	ENEC	CRI	KELVIN	OPTIC	BEAM ANGLE	LIGHTSOURCE LUMEN OUTPUT [lm]	LUMINAIRE LUMEN OUTPUT [lm]	COLOUR / FINISH	PART NUMBER	UKCA
Power LED dimmable 1-10 V 220-240 V 50/60 Hz											
330	I	✓	80	5700	C4	15°	-	39200	■	GWP2285GS	✓
330	I	✓	80	5700	C3	20°	-	39200	■	GWP2285HS	✓
330	I	✓	80	5700	C2	25°	-	38300	■	GWP2285LS	✓
330	I	✓	80	5700	C1	30°	-	38000	■	GWP2285MS	✓
330	I	✓	80	4000	C4	15°	-	39200	■	GWP2284GS	✓
330	I	✓	80	4000	C3	20°	-	39200	■	GWP2284HS	✓
330	I	✓	80	4000	C2	25°	-	38300	■	GWP2284LS	✓
330	I	✓	80	4000	C1	30°	-	38000	■	GWP2284MS	✓
330	I	✓	70	5700	C4	15°	-	42000	■	GWP2275GS	✓
330	I	✓	70	5700	C3	20°	-	42000	■	GWP2275HS	✓
330	I	✓	70	5700	C2	25°	-	41000	■	GWP2275LS	✓
330	I	✓	70	5700	C1	30°	-	40700	■	GWP2275MS	✓
330	I	✓	70	4000	C4	15°	-	42000	■	GWP2274GS	✓
330	I	✓	70	4000	C3	20°	-	42000	■	GWP2274HS	✓
330	I	✓	70	4000	C2	25°	-	41000	■	GWP2274LS	✓
330	I	✓	70	4000	C1	30°	-	40700	■	GWP2274MS	✓
330	I	✓	70	3000	C4	15°	-	39200	■	GWP2273GS	✓
330	I	✓	70	3000	C3	20°	-	39200	■	GWP2273HS	✓
330	I	✓	70	3000	C2	25°	-	38300	■	GWP2273LS	✓
330	I	✓	70	3000	C1	30°	-	38000	■	GWP2273MS	✓



Power LED dimmable DALI - 220-240 V 50/60 Hz

330	II	✓	80	4000	C4	15°	-	39200	■	GWP2284GB	✓
330	II	✓	80	4000	C3	20°	-	39200	■	GWP2284HB	✓
330	II	✓	80	4000	C2	25°	-	38300	■	GWP2284LB	✓
330	II	✓	80	4000	C1	30°	-	38000	■	GWP2284MB	✓
330	II	✓	80	3000	C4	15°	-	36400	■	GWP2283GB	✓
330	II	✓	80	3000	C3	20°	-	36400	■	GWP2283HB	✓
330	II	✓	80	3000	C2	25°	-	35600	■	GWP2283LB	✓
330	II	✓	80	3000	C1	30°	-	35300	■	GWP2283MB	✓
330	II	✓	70	5700	C4	15°	-	42000	■	GWP2275GB	✓
330	II	✓	70	5700	C3	20°	-	42000	■	GWP2275HB	✓
330	II	✓	70	5700	C2	25°	-	41000	■	GWP2275LB	✓
330	II	✓	70	5700	C1	30°	-	40700	■	GWP2275MB	✓
330	II	✓	70	4000	C4	15°	-	42000	■	GWP2274GB	✓
330	II	✓	70	4000	C3	20°	-	42000	■	GWP2274HB	✓
330	II	✓	70	4000	C2	25°	-	41000	■	GWP2274LB	✓
330	II	✓	70	4000	C1	30°	-	40700	■	GWP2274MB	✓
330	II	✓	70	3000	C4	15°	-	39200	■	GWP2273GB	✓
330	II	✓	70	3000	C3	20°	-	39200	■	GWP2273HB	✓
330	II	✓	70	3000	C2	25°	-	38300	■	GWP2273LB	✓
330	II	✓	70	3000	C1	30°	-	38000	■	GWP2273MB	✓
330	I	✓	80	5700	C4	15°	-	39200	■	GWP2285GD	✓
330	I	✓	80	5700	C3	20°	-	39200	■	GWP2285HD	✓
330	I	✓	80	5700	C2	25°	-	38300	■	GWP2285LD	✓
330	I	✓	80	5700	C1	30°	-	38000	■	GWP2285MD	✓
330	I	✓	80	4000	C4	15°	-	39200	■	GWP2284GD	✓
330	I	✓	80	4000	C3	20°	-	39200	■	GWP2284HD	✓
330	I	✓	80	4000	C2	25°	-	38300	■	GWP2284LD	✓
330	I	✓	80	4000	C1	30°	-	38000	■	GWP2284MD	✓
330	I	✓	70	5700	C4	15°	-	42000	■	GWP2275GD	✓
330	I	✓	70	5700	C3	20°	-	42000	■	GWP2275HD	✓
330	I	✓	70	5700	C2	25°	-	41000	■	GWP2275LD	✓
330	I	✓	70	5700	C1	30°	-	40700	■	GWP2275MD	✓
330	I	✓	70	4000	C4	15°	-	42000	■	GWP2274GD	✓
330	I	✓	70	4000	C3	20°	-	42000	■	GWP2274HD	✓
330	I	✓	70	4000	C2	25°	-	41000	■	GWP2274LD	✓
330	I	✓	70	4000	C1	30°	-	40700	■	GWP2274MD	✓
330	I	✓	70	3000	C4	15°	-	39200	■	GWP2273GD	✓
330	I	✓	70	3000	C3	20°	-	39200	■	GWP2273HD	✓
330	I	✓	70	3000	C2	25°	-	38300	■	GWP2273LD	✓
330	I	✓	70	3000	C1	30°	-	38000	■	GWP2273MD	✓

Optional accessories

DESCRIPTION	COLOR	PART NUMBER	UKCA
SMART [PRO] 2.0 2M			
Replacement glass		GWP2903	✓
Red Dot pointer support		GWP2904	✓
Anti-glare louvre		GWP2905	✓
Connector GW Connect 3 poles (for indoor use only)		GWP20110	✓
Connector GW Connect 4 poles (for indoor use only)		GWP20111	✓
Connector GW Connect 5 poles (for indoor use only)		GWP20112	✓
3-way connection kit		GWP20113	✓
4-way connection kit		GWP20114	✓

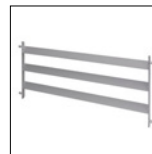

GWP2905



BMX Olympic - Verona - Italy

SMART [PRO] 2.0 2+2M

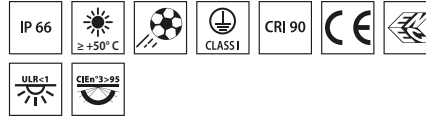

Scan the QR-code for the latest information

■ Graphite grey / Graphite grey /

High power outdoor and indoor LED projector, suitable for lighting large areas and sports facilities

- The body is fabricated in aluminium die casting EN AB 46100, with integrated passive heat sink, powder coated polyester with trivalent passivation
- Available with nine different types of optics, three types of Colour Temperature (3,000/4,000K/5,700K) and three different types of Chromatic Yield Index (CRI>70, CRI>80, CRI>90)
- Metal core PCB with CSP LED
- Remote power supply unit supplied separately (1-10V , DALI or DMX)
- Designed to withstand surges up to 5 kV (RCCB mode) and 10 kV (common mode), temperature variations from -30°C to +50°C, water and dust penetration up to IP66 degree of protection and impacts up to IK08 grade
- Insulation class I
- Electrical connection via IP68 connector for 1.5mm² cables
- Reflector made of metallic HT PC or anodised and polished aluminium
- Hardened front glass with 4mm thickness, anti-ageing silicone seals and A2 stainless steel exterior screws
- Plastic venting and anti-condensation device
- It can be installed on the wall, ceiling or ground thanks to the polyester powder coated galvanised steel bracket, with trivalent passivation, equipped with adjustable goniometric scale and supplied in kit



Albinoleffe stadium - Zanica - Italy

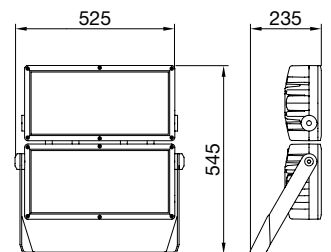

SMART [PRO] 2.0
2+2M

Identifying and classifying our optics

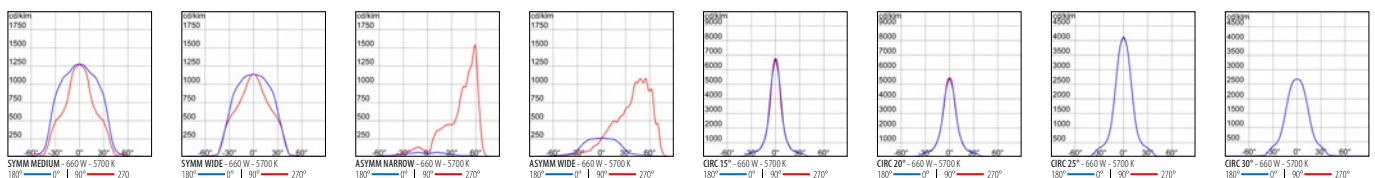

SMART [PRO] 2.0 2+2M SYMMETRIC

IP66 - IK08

LUMINAIRE WATTAGE [W]	CLASS	ENEC	CRI	KELVIN	OPTIC	BEAM ANGLE	LIGHTSOURCE LUMEN OUTPUT [lm]	LUMINAIRE LUMEN OUTPUT [lm]	COLOUR / FINISH	PART NUMBER	UKCA
Power LED - 2CH											
660	I	✓	90	5700	S1	Wide	-	65900	■	GWP2495AS	✓
660	I	✓	90	5700	S2	Medium	-	68300	■	GWP2495BS	✓
660	I	✓	80	5700	S1	Wide	-	76900	■	GWP2485AS	✓
660	I	✓	80	5700	S2	Medium	-	79700	■	GWP2485BS	✓
660	I	✓	80	4000	S1	Wide	-	76900	■	GWP2484AS	✓
660	I	✓	80	4000	S2	Medium	-	79700	■	GWP2484BS	✓
660	I	✓	70	5700	S1	Wide	-	82400	■	GWP2475AS	✓
660	I	✓	70	5700	S2	Medium	-	85400	■	GWP2475BS	✓
660	I	✓	70	4000	S1	Wide	-	82400	■	GWP2474AS	✓
660	I	✓	70	4000	S2	Medium	-	85400	■	GWP2474BS	✓
660	I	✓	70	3000	S1	Wide	-	76900	■	GWP2473AS	✓
660	I	✓	70	3000	S2	Medium	-	79700	■	GWP2473BS	✓



SMART [PRO] 2.0 2+2M ASYMMETRIC

LUMINAIRE WATTAGE [W]	CLASS	ENEC	CRI	KELVIN	OPTIC	BEAM ANGLE	LIGHTSOURCE LUMEN OUTPUT [lm]	LUMINAIRE LUMEN OUTPUT [lm]	COLOUR / FINISH	PART NUMBER	UKCA
Power LED - 2CH											
660	I	✓	90	5700	A1	Wide	-	62800	■	GWP2495CS	✓
660	I	✓	90	5700	A3	Narrow	-	70800	■	GWP2495NS	✓
660	I	✓	80	5700	A1	Wide	-	73200	■	GWP2485CS	✓
660	I	✓	80	5700	A3	Narrow	-	82600	■	GWP2485NS	✓
660	I	✓	80	4000	A1	Wide	-	73200	■	GWP2484CS	✓
660	I	✓	80	4000	A3	Narrow	-	82600	■	GWP2484NS	✓
660	I	✓	70	5700	A1	Wide	-	78500	■	GWP2475CS	✓
660	I	✓	70	5700	A3	Narrow	-	88500	■	GWP2475NS	✓
660	I	✓	70	4000	A1	Wide	-	78500	■	GWP2474CS	✓
660	I	✓	70	4000	A3	Narrow	-	88500	■	GWP2474NS	✓
660	I	✓	70	3000	A1	Wide	-	73200	■	GWP2473CS	✓
660	I	✓	70	3000	A3	Narrow	-	82600	■	GWP2473NS	✓



SMART [PRO] 2.0 2+2M CIRCULAR

IP66 - IK08

LUMINAIRE WATTAGE [W]	CLASS	ENEC	CRI	KELVIN	OPTIC	BEAM ANGLE	LIGHTSOURCE LUMEN OUTPUT [lm]	LUMINAIRE LUMEN OUTPUT [lm]	COLOUR / FINISH	PART NUMBER	UKCA
Power LED - 2CH											
660	I	✓	90	5700	C4	15°	-	67200	■	GWP2495GS	✓
660	I	✓	90	5700	C3	20°	-	67100	■	GWP2495HS	✓
660	I	✓	90	5700	C2	25°	-	65700	■	GWP2495LS	✓
660	I	✓	90	5700	C1	30°	-	65100	■	GWP2495MS	✓
660	I	✓	80	5700	C4	15°	-	78400	■	GWP2485GS	✓
660	I	✓	80	5700	C3	20°	-	78300	■	GWP2485HS	✓
660	I	✓	80	5700	C2	25°	-	76600	■	GWP2485LS	✓
660	I	✓	80	5700	C1	30°	-	76000	■	GWP2485MS	✓
660	I	✓	80	4000	C4	15°	-	78400	■	GWP2484GS	✓
660	I	✓	80	4000	C3	20°	-	78300	■	GWP2484HS	✓
660	I	✓	80	4000	C2	25°	-	76600	■	GWP2484LS	✓
660	I	✓	80	4000	C1	30°	-	76000	■	GWP2484MS	✓
660	I	✓	70	5700	C4	15°	-	84000	■	GWP2475GS	✓
660	I	✓	70	5700	C3	20°	-	83900	■	GWP2475HS	✓
660	I	✓	70	5700	C2	25°	-	82100	■	GWP2475LS	✓
660	I	✓	70	5700	C1	30°	-	81400	■	GWP2475MS	✓
660	I	✓	70	4000	C4	15°	-	84000	■	GWP2474GS	✓
660	I	✓	70	4000	C3	20°	-	83900	■	GWP2474HS	✓
660	I	✓	70	4000	C2	25°	-	82100	■	GWP2474LS	✓
660	I	✓	70	4000	C1	30°	-	81400	■	GWP2474MS	✓
660	I	✓	70	3000	C4	15°	-	78400	■	GWP2473GS	✓
660	I	✓	70	3000	C3	20°	-	78300	■	GWP2473HS	✓
660	I	✓	70	3000	C2	25°	-	76600	■	GWP2473LS	✓
660	I	✓	70	3000	C1	30°	-	76000	■	GWP2473MS	✓



Control gear

DESCRIPTION	COLOR	PART NUMBER	UKCA
SMART [PRO] 2.0 2+2M			
Power supply unit connection kit		GWP2909	✓
Power supply unit 1-10 V 220-240 V		GWP2901	✓
Power supply unit DALI 220-400 V		GWP2910	✓
Power supply unit DMX 220-400 V		GWP2911	✓

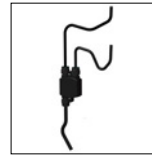

GWP2909

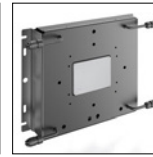

GWP2901

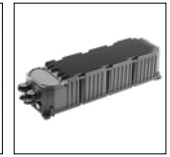

**GWP2910
GWP2911**

Optional accessories

DESCRIPTION	COLOR	PART NUMBER	UKCA
SMART [PRO] 2.0 2+2M			
Replacement glass		GWP2903	✓
Red Dot pointer support		GWP2904	✓
Anti-glare louvre		GWP2905	✓
Connector GW Connect 7 poles		GWP30008	✓
Support bracket		GWP2912	✓
Power supply unit mounting bracket		GWP2913	✓
3-way connection kit		GWP20113	✓
4-way connection kit		GWP20114	✓

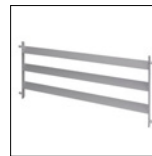

GWP2905



Albinoleffe stadium - Zanica - Italy

SMART [PRO] 2.0 3X2M

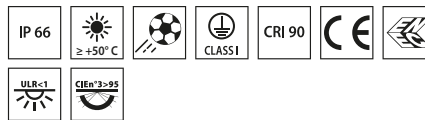

Scan the QR-code for the latest information

■ Graphite grey / Graphite grey /

High-power outdoor and indoor LED projector, suitable for lighting large areas and sports facilities

- The body is fabricated in aluminium die casting EN AB 46100, with integrated passive heat dissipation, powder-coated polyester paint with trivalent passivation
- Available with nine different types of optics, three types of Colour Temperature (3,000/4,000K/5,700K) and three different types of Color Rendering Index (CRI>70, CRI>80, CRI>90)
- PCB metal core with CSP LED
- Remote power supply unit in DALI or DMX options, multiple electrical connection kits, supplied separately
- Designed to withstand surges up to 5 kV (RCCB mode) and 10 kV (common mode), temperature variations from -30°C to +50°C, water and dust penetration up to IP66 protection grade and shockproof up to IK08 grade
- Insulation class I
- Electrical connection via IP68 connector for 1.5mm² cables
- Reflector made of metallic HT PC or anodised and polished aluminium
- Hardened front glass with 4mm thickness, anti-ageing silicone seals and A2 stainless steel exterior screws
- Fixing screws with GEOMET® treatment
- Equipped with a venting and anti-condensation valve
- It can be installed on the wall, ceiling or ground thanks to the polyester powder coated galvanised steel bracket with trivalent passivation, equipped with adjustable goniometric scale and supplied in a kit

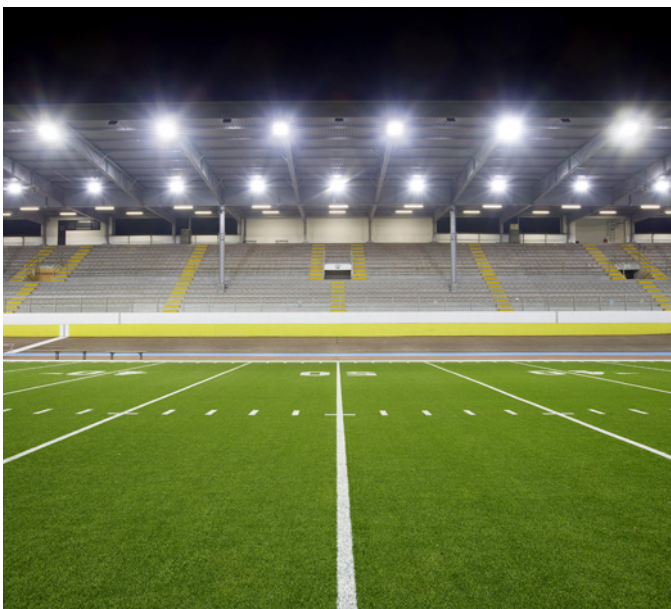

Velodrome Maspes-Vigorelli - Milan - Italy

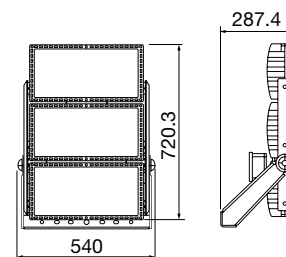

SMART [PRO] 2.0
3x2M

Identifying and classifying our optics

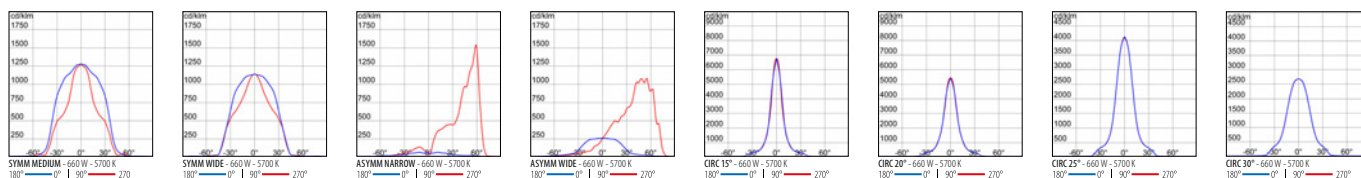

SMART [PRO] 2.0 3X2M SYMMETRIC

IP66 - IK08

LUMINAIRE WATTAGE [W]	CLASS	ENEC	CRI	KELVIN	OPTIC	BEAM ANGLE	LIGHTSOURCE LUMEN OUTPUT (lm)	LUMINAIRE LUMEN OUTPUT (lm)	COLOUR / FINISH	PART NUMBER	UKCA
Power LED - 3CH											
970	I	✓	90	5700	S1	Wide	-	98900	■	GWP2630AA957	✓
970	I	✓	90	5700	S2	Medium	-	102400	■	GWP2630AB957	✓
970	I	✓	80	5700	S1	Wide	-	115400	■	GWP2630AA857	✓
970	I	✓	80	5700	S2	Medium	-	119500	■	GWP2630AB857	✓
970	I	✓	80	4000	S1	Wide	-	115400	■	GWP2630AA840	✓
970	I	✓	80	4000	S2	Medium	-	119500	■	GWP2630AB840	✓
970	I	✓	70	5700	S1	Wide	-	123600	■	GWP2630AA757	✓
970	I	✓	70	5700	S2	Medium	-	128100	■	GWP2630AB757	✓
970	I	✓	70	4000	S1	Wide	-	123600	■	GWP2630AA740	✓
970	I	✓	70	4000	S2	Medium	-	128100	■	GWP2630AB740	✓
970	I	✓	70	3000	S1	Wide	-	115400	■	GWP2630AA730	✓
970	I	✓	70	3000	S2	Medium	-	119500	■	GWP2630AB730	✓



SMART [PRO] 2.0 3X2M ASYMMETRIC

IP66 - IK08

LUMINAIRE WATTAGE [W]	CLASS	ENEC	CRI	KELVIN	OPTIC	BEAM ANGLE	LIGHTSOURCE LUMEN OUTPUT (lm)	LUMINAIRE LUMEN OUTPUT (lm)	COLOUR / FINISH	PART NUMBER	UKCA
Power LED - 3CH											
970	I	✓	90	5700	A1	Wide	-	94200	■	GWP2630AC957	✓
970	I	✓	90	5700	A3	Narrow	-	106200	■	GWP2630AN957	✓
970	I	✓	80	5700	A1	Wide	-	109800	■	GWP2630AC857	✓
970	I	✓	80	5700	A3	Narrow	-	123900	■	GWP2630AN857	✓
970	I	✓	80	4000	A1	Wide	-	109800	■	GWP2630AC840	✓
970	I	✓	80	4000	A3	Narrow	-	123900	■	GWP2630AN840	✓
970	I	✓	70	5700	A1	Wide	-	117700	■	GWP2630AC757	✓
970	I	✓	70	5700	A3	Narrow	-	132800	■	GWP2630AN757	✓
970	I	✓	70	4000	A1	Wide	-	117700	■	GWP2630AC740	✓
970	I	✓	70	4000	A3	Narrow	-	132800	■	GWP2630AN740	✓
970	I	✓	70	3000	A1	Wide	-	109800	■	GWP2630AC730	✓
970	I	✓	70	3000	A3	Narrow	-	123900	■	GWP2630AN730	✓



SMART [PRO] 2.0 3X2M CIRCULAR

IP66 - IK08

LUMINAIRE WATTAGE [W]	CLASS	ENEC	CRI	KELVIN	OPTIC	BEAM ANGLE	LIGHTSOURCE LUMEN OUTPUT (lm)	LUMINAIRE LUMEN OUTPUT (lm)	COLOUR / FINISH	PART NUMBER	UKCA
Power LED - 3CH											
970	I	✓	90	5700	C4	15°	-	100700	■	GWP2630AG957	✓
970	I	✓	90	5700	C3	20°	-	100700	■	GWP2630AH957	✓
970	I	✓	90	5700	C2	25°	-	98500	■	GWP2630AL957	✓
970	I	✓	90	5700	C1	30°	-	97700	■	GWP2630AM957	✓
970	I	✓	80	5700	C4	15°	-	117500	■	GWP2630AG857	✓
970	I	✓	80	5700	C3	20°	-	117500	■	GWP2630AH857	✓
970	I	✓	80	5700	C2	25°	-	114900	■	GWP2630AL857	✓
970	I	✓	80	5700	C1	30°	-	114000	■	GWP2630AM857	✓
970	I	✓	80	4000	C4	15°	-	117500	■	GWP2630AG840	✓
970	I	✓	80	4000	C3	20°	-	117500	■	GWP2630AH840	✓
970	I	✓	80	4000	C2	25°	-	114900	■	GWP2630AL840	✓
970	I	✓	80	4000	C1	30°	-	114000	■	GWP2630AM840	✓
970	I	✓	70	5700	C4	15°	-	125900	■	GWP2630AG757	✓
970	I	✓	70	5700	C3	20°	-	125900	■	GWP2630AH757	✓
970	I	✓	70	5700	C2	25°	-	123100	■	GWP2630AL757	✓
970	I	✓	70	5700	C1	30°	-	122100	■	GWP2630AM757	✓
970	I	✓	70	4000	C4	15°	-	125900	■	GWP2630AG740	✓
970	I	✓	70	4000	C3	20°	-	125900	■	GWP2630AH740	✓
970	I	✓	70	4000	C2	25°	-	123100	■	GWP2630AL740	✓
970	I	✓	70	4000	C1	30°	-	122100	■	GWP2630AM740	✓
970	I	✓	70	3000	C4	15°	-	117500	■	GWP2630AG730	✓
970	I	✓	70	3000	C3	20°	-	117500	■	GWP2630AH730	✓
970	I	✓	70	3000	C2	25°	-	114900	■	GWP2630AL730	✓
970	I	✓	70	3000	C1	30°	-	114000	■	GWP2630AM730	✓



Control gear

DESCRIPTION	COLOR	PART NUMBER	UKCA
SMART [PRO] 2.0 3X2M			
Power supply unit DALI 220-400 V		GWP20031	✓
Power supply unit DMX 220-400 V		GWP20032	✓

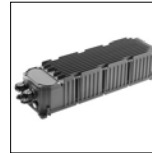

GWP20031
GWP20032

Optional accessories

DESCRIPTION	COLOR	PART NUMBER	UKCA
SMART [PRO] 2.0 3X2M			
Replacement glass		GWP2903	✓
Red Dot pointer support		GWP2904	✓
Anti-glare louvre		GWP2905	✓
Connector GW Connect 12 poles		GWP20004	✓
3-way connection kit		GWP20113	✓
4-way connection kit		GWP20114	✓
Power supply unit mounting bracket		GWP20006	✓
H07RN-F 12x1,5 mm ² cable - skein 50 m		GWP20005	✓

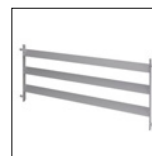

GWP2905

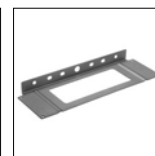

GWP20006

STADIUM PRO 1M

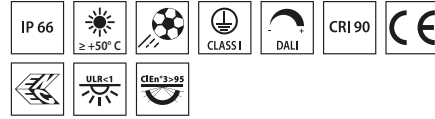

■ Graphite grey / Graphite grey /

Scan the QR-code for the latest information

High-power LED floodlight, with high-emittance LES (light emitting surface), suitable for lighting small or medium-sized sporting facilities

- The floodlight has a graphite grey finish with trivalent treatment for maximum resistance to oxidation and is equipped with an integrated 'self-cleaning' heat dissipation system
- The floodlight is available in the following colour temperatures 4,000K or 5,700K and colour rendering CRI>70, CRI>80 o CRI>90 (TLCI>80)
- The range offers 6 types of circular optics, from 8° up to 40°, 1 symmetrical/elliptical optic and 2 asymmetric optics
- The powers supply unit available in DALI or DMX-RDM versions acan be oriented to optimise the heat dispersion depending on the orientation of the motor
- The floodlight is completed with the power supply unit fixed onto the back of the heat sink
- It is protected from surges up to 6 kV in differential mode and 10 kV in common mode
- The T.I.R.Ex.optic system developed by GEWISS with lenses in PMMA HT (high-transparency), gives complete control over the light beam, allowing for great flexibility in any project design, with high qualitative and quantitative performance
- With a bleed and anti-condensation valve, protected from accidental impact
- The orientation system is enabled by the goniometer integrated into the bracket, which facilitates the pointing phases during installation



Velodrome Maspes-Vigorelli - Milan - Italy

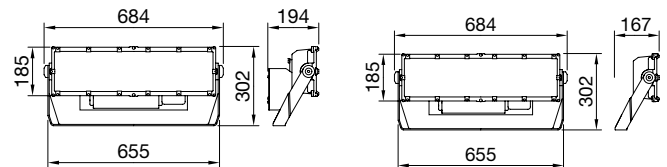

STADIUM PRO
1M

STADIUM PRO
1M RM

Identifying and classifying our optics

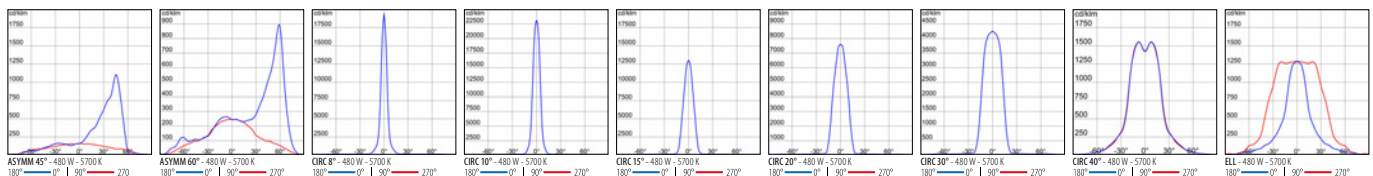

STADIUM PRO 1M SYMMETRIC

IP66 - IK08



LUMINAIRE WATTAGE (W)	CLASS	ENEC	CRI	KELVIN	OPTIC	BEAM ANGLE	LIGHTSOURCE LUMEN OUTPUT (lm)	LUMINAIRE LUMEN OUTPUT (lm)	COLOUR / FINISH	PART NUMBER	UKCA
Power LED dimmable DALI - 220-240 V 50/60 Hz											
480	I	✓	90	5700	ELL	20°x80°	-	39500	■	GWP3131DA957	✓
480	I	✓	90	5700	C1	40°	-	39500	■	GWP3131DF957	✓
480	I	✓	90	5700	C2	30°	-	41500	■	GWP3131DG957	✓
480	I	✓	90	5700	C3	20°	-	41500	■	GWP3131DH957	✓
480	I	✓	90	5700	C4	15°	-	43000	■	GWP3131DL957	✓
480	I	✓	90	5700	C5	10°	-	43000	■	GWP3131DM957	✓
480	I	✓	90	5700	C6	8°	-	39500	■	GWP3131DN957	✓
480	I	✓	80	5700	ELL	20°x80°	-	46000	■	GWP3131DA857	✓
480	I	✓	80	5700	C1	40°	-	46000	■	GWP3131DF857	✓
480	I	✓	80	5700	C2	30°	-	49000	■	GWP3131DG857	✓
480	I	✓	80	5700	C3	20°	-	49000	■	GWP3131DH857	✓
480	I	✓	80	5700	C4	15°	-	50500	■	GWP3131DL857	✓
480	I	✓	80	5700	C5	10°	-	50500	■	GWP3131DM857	✓
480	I	✓	80	5700	C6	8°	-	46000	■	GWP3131DN857	✓
480	I	✓	80	4000	ELL	20°x80°	-	46000	■	GWP3131DA840	✓
480	I	✓	80	4000	C1	40°	-	46000	■	GWP3131DF840	✓
480	I	✓	80	4000	C2	30°	-	49000	■	GWP3131DG840	✓
480	I	✓	80	4000	C3	20°	-	49000	■	GWP3131DH840	✓
480	I	✓	80	4000	C4	15°	-	50500	■	GWP3131DL840	✓
480	I	✓	80	4000	C5	10°	-	50500	■	GWP3131DM840	✓
480	I	✓	80	4000	C6	8°	-	46000	■	GWP3131DN840	✓
480	I	✓	70	5700	ELL	20°x80°	-	53500	■	GWP3131DA757	✓
480	I	✓	70	5700	C1	40°	-	53500	■	GWP3131DF757	✓
480	I	✓	70	5700	C2	30°	-	56500	■	GWP3131DG757	✓
480	I	✓	70	5700	C3	20°	-	56500	■	GWP3131DH757	✓
480	I	✓	70	5700	C4	15°	-	58500	■	GWP3131DL757	✓
480	I	✓	70	5700	C5	10°	-	58500	■	GWP3131DM757	✓
480	I	✓	70	5700	C6	8°	-	53500	■	GWP3131DN757	✓
480	I	✓	70	4000	ELL	20°x80°	-	53500	■	GWP3131DA740	✓
480	I	✓	70	4000	C1	40°	-	53500	■	GWP3131DF740	✓
480	I	✓	70	4000	C2	30°	-	56500	■	GWP3131DG740	✓
480	I	✓	70	4000	C3	20°	-	56500	■	GWP3131DH740	✓
480	I	✓	70	4000	C4	15°	-	58500	■	GWP3131DL740	✓
480	I	✓	70	4000	C5	10°	-	58500	■	GWP3131DM740	✓
480	I	✓	70	4000	C6	8°	-	53500	■	GWP3131DN740	✓

STADIUM PRO 1M ASYMMETRIC

IP66 - IK08



LUMINAIRE WATTAGE (W)	CLASS	ENEC	CRI	KELVIN	OPTIC	BEAM ANGLE	LIGHTSOURCE LUMEN OUTPUT (lm)	LUMINAIRE LUMEN OUTPUT (lm)	COLOUR / FINISH	PART NUMBER	UKCA
Power LED dimmable DALI - 220-240 V 50/60 Hz											
480	I	✓	90	5700	A1	45°	-	38000	■	GWP3131DB957	✓
480	I	✓	90	5700	A2	60°	-	37000	■	GWP3131DC957	✓
480	I	✓	80	5700	A1	45°	-	44500	■	GWP3131DB857	✓
480	I	✓	80	5700	A2	60°	-	43000	■	GWP3131DC857	✓
480	I	✓	80	4000	A1	45°	-	44500	■	GWP3131DB840	✓
480	I	✓	80	4000	A2	60°	-	43000	■	GWP3131DC840	✓
480	I	✓	70	5700	A1	45°	-	51000	■	GWP3131DB757	✓
480	I	✓	70	5700	A2	60°	-	49500	■	GWP3131DC757	✓
480	I	✓	70	4000	A1	45°	-	51000	■	GWP3131DB740	✓
480	I	✓	70	4000	A2	60°	-	49500	■	GWP3131DC740	✓

STADIUM PRO 1M RM SYMMETRIC

IP66 - IK08

LUMINAIRE WATTAGE [W]	CLASS	ENEC	CRI	KELVIN	OPTIC	BEAM ANGLE	LIGHTSOURCE LUMEN OUTPUT [lm]	LUMINAIRE LUMEN OUTPUT [lm]	COLOUR / FINISH	PART NUMBER	UKCA
Power LED - 1CH											
480	I	✓	90	5700	ELL	20°x80°	-	39500	■	GWP3131AA957	✓
480	I	✓	90	5700	C1	40°	-	39500	■	GWP3131AF957	✓
480	I	✓	90	5700	C2	30°	-	41500	■	GWP3131AG957	✓
480	I	✓	90	5700	C3	20°	-	41500	■	GWP3131AH957	✓
480	I	✓	90	5700	C4	15°	-	43000	■	GWP3131AL957	✓
480	I	✓	90	5700	C5	10°	-	43000	■	GWP3131AM957	✓
480	I	✓	90	5700	C6	8°	-	39500	■	GWP3131AN957	✓
480	I	✓	80	5700	ELL	20°x80°	-	46000	■	GWP3131AA857	✓
480	I	✓	80	5700	C1	40°	-	46000	■	GWP3131AF857	✓
480	I	✓	80	5700	C2	30°	-	49000	■	GWP3131AG857	✓
480	I	✓	80	5700	C3	20°	-	49000	■	GWP3131AH857	✓
480	I	✓	80	5700	C4	15°	-	50500	■	GWP3131AL857	✓
480	I	✓	80	5700	C5	10°	-	50500	■	GWP3131AM857	✓
480	I	✓	80	5700	C6	8°	-	46000	■	GWP3131AN857	✓
480	I	✓	80	4000	ELL	20°x80°	-	46000	■	GWP3131AA840	✓
480	I	✓	80	4000	C1	40°	-	46000	■	GWP3131AF840	✓
480	I	✓	80	4000	C2	30°	-	49000	■	GWP3131AG840	✓
480	I	✓	80	4000	C3	20°	-	49000	■	GWP3131AH840	✓
480	I	✓	80	4000	C4	15°	-	50500	■	GWP3131AL840	✓
480	I	✓	80	4000	C5	10°	-	50500	■	GWP3131AM840	✓
480	I	✓	80	4000	C6	8°	-	46000	■	GWP3131AN840	✓
480	I	✓	70	5700	ELL	20°x80°	-	53500	■	GWP3131AA757	✓
480	I	✓	70	5700	C1	40°	-	53500	■	GWP3131AF757	✓
480	I	✓	70	5700	C2	30°	-	56500	■	GWP3131AG757	✓
480	I	✓	70	5700	C3	20°	-	56500	■	GWP3131AH757	✓
480	I	✓	70	5700	C4	15°	-	58500	■	GWP3131AL757	✓
480	I	✓	70	5700	C5	10°	-	58500	■	GWP3131AM757	✓
480	I	✓	70	5700	C6	8°	-	53500	■	GWP3131AN757	✓
480	I	✓	70	4000	ELL	20°x80°	-	53500	■	GWP3131AA740	✓
480	I	✓	70	4000	C1	40°	-	53500	■	GWP3131AF740	✓
480	I	✓	70	4000	C2	30°	-	56500	■	GWP3131AG740	✓
480	I	✓	70	4000	C3	20°	-	56500	■	GWP3131AH740	✓
480	I	✓	70	4000	C4	15°	-	58500	■	GWP3131AL740	✓
480	I	✓	70	4000	C5	10°	-	58500	■	GWP3131AM740	✓
480	I	✓	70	4000	C6	8°	-	53500	■	GWP3131AN740	✓



STADIUM PRO 1M RM ASYMMETRIC

IP66 - IK08

LUMINAIRE WATTAGE [W]	CLASS	ENEC	CRI	KELVIN	OPTIC	BEAM ANGLE	LIGHTSOURCE LUMEN OUTPUT [lm]	LUMINAIRE LUMEN OUTPUT [lm]	COLOUR / FINISH	PART NUMBER	UKCA
Power LED - 1CH											
480	I	✓	90	5700	A1	45°	-	38000	■	GWP3131AB957	✓
480	I	✓	90	5700	A2	60°	-	37000	■	GWP3131AC957	✓
480	I	✓	80	5700	A1	45°	-	44500	■	GWP3131AB857	✓
480	I	✓	80	5700	A2	60°	-	43000	■	GWP3131AC857	✓
480	I	✓	80	4000	A1	45°	-	44500	■	GWP3131AB840	✓
480	I	✓	80	4000	A2	60°	-	43000	■	GWP3131AC840	✓
480	I	✓	70	5700	A1	45°	-	51000	■	GWP3131AB757	✓
480	I	✓	70	5700	A2	60°	-	49500	■	GWP3131AC757	✓
480	I	✓	70	4000	A1	45°	-	51000	■	GWP3131AB740	✓
480	I	✓	70	4000	A2	60°	-	49500	■	GWP3131AC740	✓



Control gear

DESCRIPTION	COLOR	PART NUMBER	UKCA
STADIUM PRO 1M RM			
Single driver 0-10 V 220-240 V		GWP30017	✓
Single driver DALI 220-240 V		GWP30015	✓
Power supply unit DALI 220-240 V		GWP30040	✓
Power supply unit DMX 220-240 V		GWP30041	✓

Optional accessories

DESCRIPTION	COLOR	PART NUMBER	UKCA
STADIUM PRO 1M RM			
Red Dot pointer support		GWP30004	✓
Anti-glare louvre for circular optic versions		GWP30002	✓
Visor for symmetric or circular optic versions		GWP30003	✓
3-way connection kit		GWP20113	✓
4-way connection kit		GWP20114	✓
STADIUM PRO 1M /SYMM			
Replacement glass for symmetric optic versions		GWP30006	✓
STADIUM PRO 1M /ASYMM			
Replacement glass for asymmetric optic versions		GWP30009	✓



GWP30004

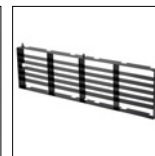

GWP30002



GWP30003

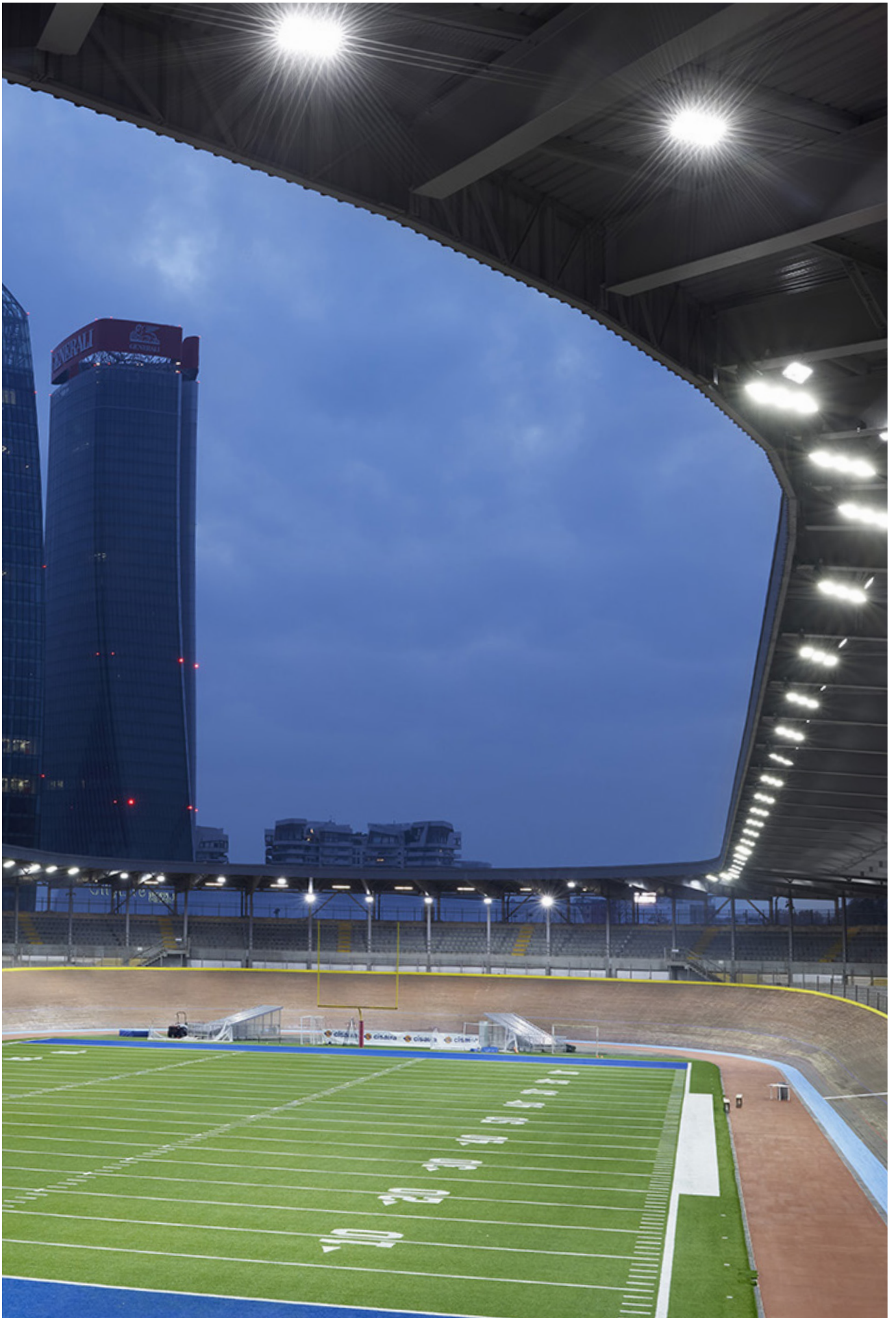

Velodrome Maspes-Vigorelli - Milan - Italy

STADIUM PRO 2M

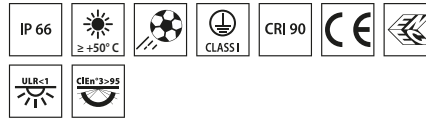
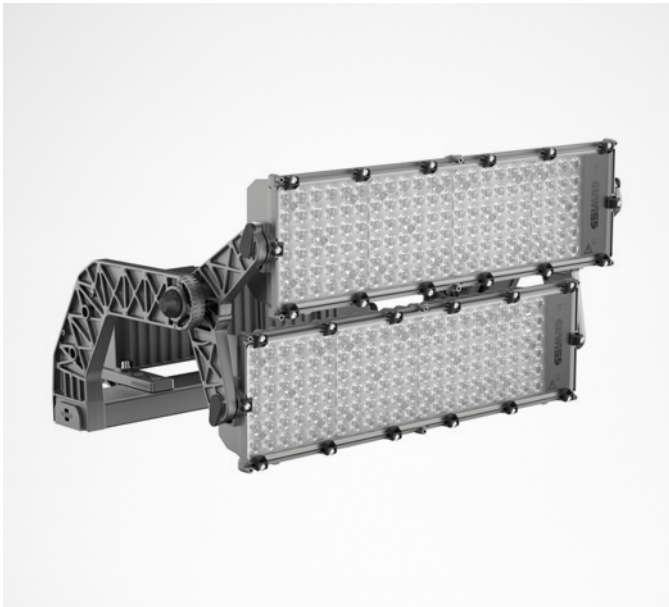

Scan the QR-code for the latest information

■ Graphite grey / Graphite grey /

- High-power LED floodlight, with a high-emittance LES (light emitting surface), suitable for lighting professional and semi-professional sporting facilities
- The floodlight has a graphite grey finish with trivalent treatment for maximum resistance to oxidation and is equipped with an integrated 'self-cleaning' heat dissipation system
 - The floodlight is available in the following colour temperatures 4,000K or 5,700K and colour rendering CRI>70, CRI>80 o CRI>90 (TLCI>80)
 - The range offers 6 types of circular optics, from 8° up to 40°, 1 symmetrical/elliptical optic and 2 asymmetric optics
 - The range requires a DALI2 or DMX-RDM power supply to permit the greatest flexibility in the creation of lighting scenarios, even of great complexity
 - The power supply box can be installed on the bracket or remote, and is protected from surges up to 10 kV, either in differential or common mode, with a single cable
 - The T.I.R.Ex.optic system developed by GEWISS with lenses in PMMA HT (high-transparency), gives complete control over the light beam, allowing for great flexibility in any project design, with high qualitative and quantitative performance
 - It consists of 2 modules, each with a bleed and anti-condensation valve, protected from accidental impact
 - The rotation system between the brackets and optic modules is of the truncated-conical aluminium type, with an integrated goniometer in the bracket for easy control of orientation, and screw and grub screw fastening, which guarantees the fastness of each individual module over time

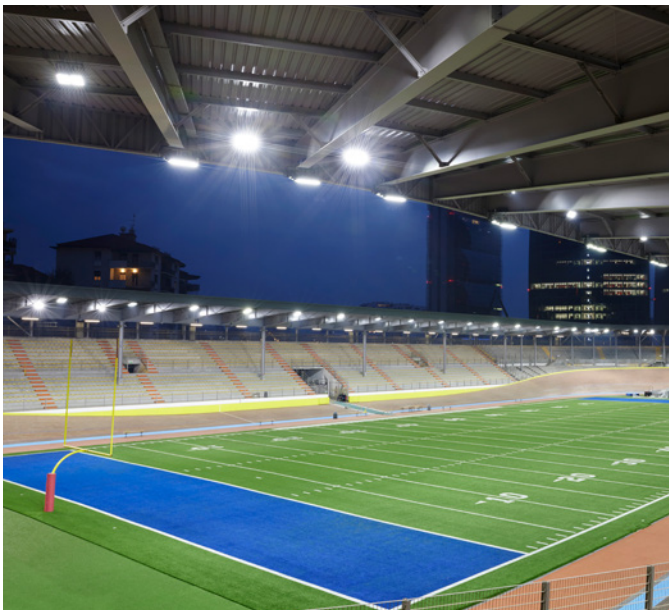

Velodrome Maspes-Vigorelli - Milan - Italy

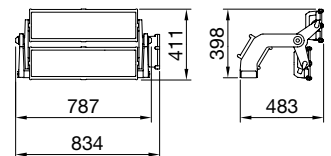

STADIUM PRO
2M

Identifying and classifying our optics

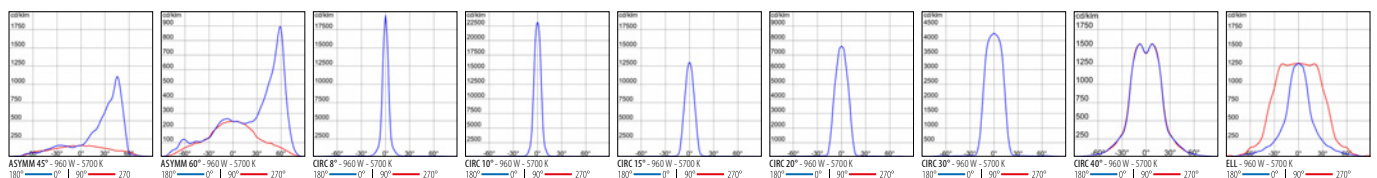

Sports and Area

STADIUM PRO 2M SYMMETRIC

IP66 - IK08

LUMINAIRE WATTAGE [W]	CLASS	ENEC	CRI	KELVIN	OPTIC	BEAM ANGLE	LIGHTSOURCE LUMEN OUTPUT [lm]	LUMINAIRE LUMEN OUTPUT [lm]	COLOUR / FINISH	PART NUMBER	UKCA
Power LED - 2CH											
960	I	✓	90	5700	ELL	20°x80°	-	79000	■	GWP3231AA957	✓
960	I	✓	90	5700	C1	40°	-	79000	■	GWP3231AF957	✓
960	I	✓	90	5700	C2	30°	-	83000	■	GWP3231AG957	✓
960	I	✓	90	5700	C3	20°	-	83000	■	GWP3231AH957	✓
960	I	✓	90	5700	C4	15°	-	86000	■	GWP3231AL957	✓
960	I	✓	90	5700	C5	10°	-	86000	■	GWP3231AM957	✓
960	I	✓	90	5700	C6	8°	-	79000	■	GWP3231AN957	✓
960	I	✓	80	5700	ELL	20°x80°	-	92000	■	GWP3231AA857	✓
960	I	✓	80	5700	C1	40°	-	92000	■	GWP3231AF857	✓
960	I	✓	80	5700	C2	30°	-	98000	■	GWP3231AG857	✓
960	I	✓	80	5700	C3	20°	-	98000	■	GWP3231AH857	✓
960	I	✓	80	5700	C4	15°	-	101000	■	GWP3231AL857	✓
960	I	✓	80	5700	C5	10°	-	101000	■	GWP3231AM857	✓
960	I	✓	80	5700	C6	8°	-	92000	■	GWP3231AN857	✓
960	I	✓	80	4000	ELL	20°x80°	-	92000	■	GWP3231AA840	✓
960	I	✓	80	4000	C1	40°	-	92000	■	GWP3231AF840	✓
960	I	✓	80	4000	C2	30°	-	98000	■	GWP3231AG840	✓
960	I	✓	80	4000	C3	20°	-	98000	■	GWP3231AH840	✓
960	I	✓	80	4000	C4	15°	-	101000	■	GWP3231AL840	✓
960	I	✓	80	4000	C5	10°	-	101000	■	GWP3231AM840	✓
960	I	✓	80	4000	C6	8°	-	92000	■	GWP3231AN840	✓
960	I	✓	70	5700	ELL	20°x80°	-	107000	■	GWP3231AA757	✓
960	I	✓	70	5700	C1	40°	-	107000	■	GWP3231AF757	✓
960	I	✓	70	5700	C2	30°	-	113000	■	GWP3231AG757	✓
960	I	✓	70	5700	C3	20°	-	113000	■	GWP3231AH757	✓
960	I	✓	70	5700	C4	15°	-	117000	■	GWP3231AL757	✓
960	I	✓	70	5700	C5	10°	-	117000	■	GWP3231AM757	✓
960	I	✓	70	5700	C6	8°	-	107000	■	GWP3231AN757	✓
960	I	✓	70	4000	ELL	20°x80°	-	107000	■	GWP3231AA740	✓
960	I	✓	70	4000	C1	40°	-	107000	■	GWP3231AF740	✓
960	I	✓	70	4000	C2	30°	-	113000	■	GWP3231AG740	✓
960	I	✓	70	4000	C3	20°	-	113000	■	GWP3231AH740	✓
960	I	✓	70	4000	C4	15°	-	117000	■	GWP3231AL740	✓
960	I	✓	70	4000	C5	10°	-	117000	■	GWP3231AM740	✓
960	I	✓	70	4000	C6	8°	-	107000	■	GWP3231AN740	✓



STADIUM PRO 2M ASYMMETRIC

IP66 - IK08

LUMINAIRE WATTAGE [W]	CLASS	ENEC	CRI	KELVIN	OPTIC	BEAM ANGLE	LIGHTSOURCE LUMEN OUTPUT [lm]	LUMINAIRE LUMEN OUTPUT [lm]	COLOUR / FINISH	PART NUMBER	UKCA
Power LED - 2CH											
960	I	✓	90	5700	A1	45°	-	76000	■	GWP3231AB957	✓
960	I	✓	90	5700	A2	60°	-	73000	■	GWP3231AC957	✓
960	I	✓	80	5700	A1	45°	-	89000	■	GWP3231AB857	✓
960	I	✓	80	5700	A2	60°	-	86000	■	GWP3231AC857	✓
960	I	✓	80	4000	A1	45°	-	89000	■	GWP3231AB840	✓
960	I	✓	80	4000	A2	60°	-	86000	■	GWP3231AC840	✓
960	I	✓	70	5700	A1	45°	-	102000	■	GWP3231AB757	✓
960	I	✓	70	5700	A2	60°	-	99000	■	GWP3231AC757	✓
960	I	✓	70	4000	A1	45°	-	102000	■	GWP3231AB740	✓
960	I	✓	70	4000	A2	60°	-	99000	■	GWP3231AC740	✓



Control gear

DESCRIPTION	COLOR	PART NUMBER	UKCA
STADIUM PRO 2M			
Single driver 0-10 V 220-240 V		GWP30017	✓
Single driver DALI 220-240 V		GWP30015	✓
Driver box 0-10 V 220-240 V		GWP30025	✓
Driver box DALI 220-240 V		GWP30023	✓
Power supply unit DALI 220-400 V		GWP30021	✓
Power supply unit DMX 220-400 V		GWP30022	✓
Power supply unit connection kit		GWP30020	✓

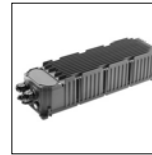

GWP30021
GWP30022

Optional accessories

DESCRIPTION	COLOR	PART NUMBER	UKCA
STADIUM PRO 2M			
Anti-glare louvre for circular optic versions		GWP30002	✓
Visor for symmetric or circular optic versions		GWP30003	✓
Red Dot pointer support		GWP30004	✓
Connector GW Connect 7 poles		GWP30008	✓
STADIUM PRO 2M - A			
Replacement glass for asymmetric optic versions		GWP30009	✓
STADIUM PRO 2M - S			
Replacement glass for symmetric optic versions		GWP30006	✓

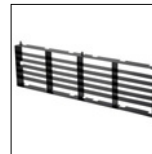

GWP30002

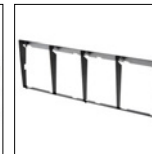

GWP30003



GWP30004



Gewiss Stadium - Bergamo - Italy

STADIUM PRO 3M

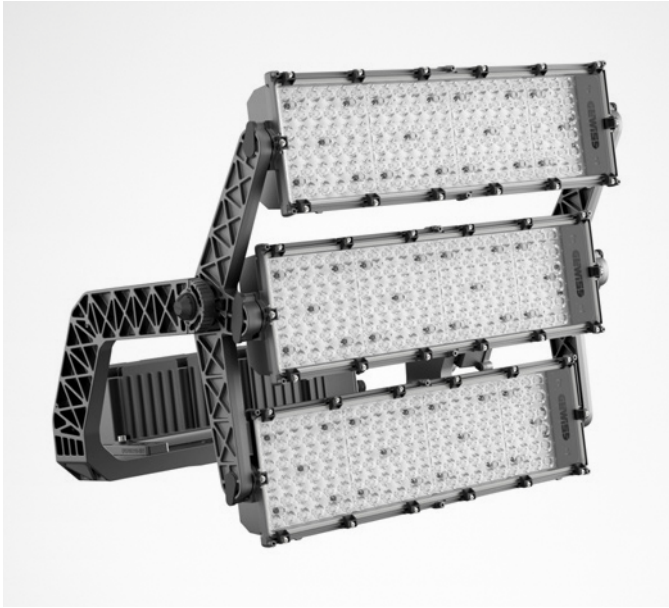

Gewiss Stadium - Bergamo - Italy

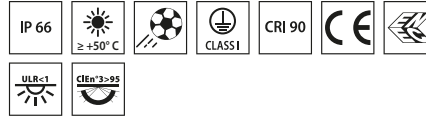

Scan the QR-code for the latest information

■ Graphite grey / Graphite grey /

High-power LED floodlight, with an LES (light emitting surface) high emission, suitable for lighting sports facilities for professional competitive competitions

- Stadium Pro is for a professional use hence the photometric data are not disclosed. We invite you to take contact with our technical and commercial teams
- The spotlight has a graphite grey finish with trivalent treatment for maximum resistance to oxidation and is equipped with an integrated "self-cleaning" thermal dissipation system
- The spotlight is available in 4,000K or 5,700K colour temperatures and CRI>70, CRI>80 or CRI>90 (TLCI>80) colour rendering
- The range also includes 6 types of circular optics, from 8° to 40°, 1 symmetrical/ Elliptical optic and 2 asymmetric optics
- The range includes a DALI2 or DMX-RDM power supply, to allow maximum flexibility in the creation of even complex light sets
- The power supply box can be fixed on the edge-bracket, or remotely, it is immune to surges of up to 10 kV both in RCCB and common mode, with a single cable
- The T.I.R.Ex optical system developed by GEWISS, with high transparency PMMA HT lenses, permits total control over the light beam, allowing for wide flexibility in the design environment, with high qualitative and quantitative performance
- It consists of three modules, each with a venting and non-condensing valve, protected from accidental impacts
- The rotation system between the bracket and the optical modules is truncated-conical in aluminium with an integrated goniometer within the bracket for easy orientation control and fixing by means of a grub-screw, which ensure the tightness over time of each individual module

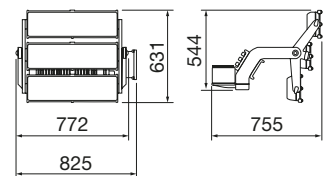

STADIUM PRO
3M

Identifying and classifying our optics

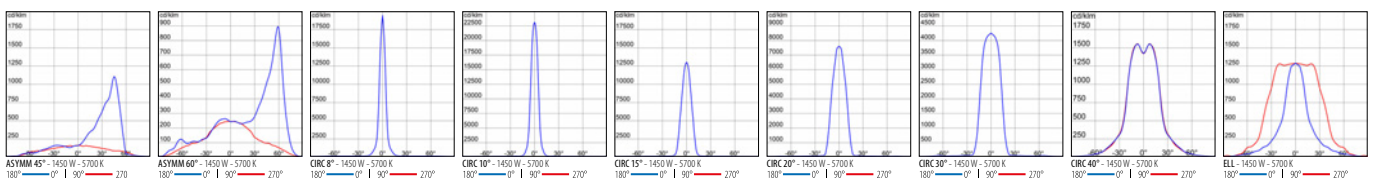

Sports and Area

STADIUM PRO 3M SYMMETRIC

IP66 - IK08

LUMINAIRE WATTAGE (W)	CLASS	ENEC	CRI	KELVIN	OPTIC	BEAM ANGLE	LIGHTSOURCE LUMEN OUTPUT (lm)	LUMINAIRE LUMEN OUTPUT (lm)	COLOUR / FINISH	PART NUMBER	UKCA
Power LED - 3CH											
1450	I	✓	90	5700	ELL	20°x80°	-	118000	■	GWP3331AA957	✓
1450	I	✓	90	5700	C1	40°	-	118000	■	GWP3331AF957	✓
1450	I	✓	90	5700	C2	30°	-	125000	■	GWP3331AG957	✓
1450	I	✓	90	5700	C3	20°	-	125000	■	GWP3331AH957	✓
1450	I	✓	90	5700	C4	15°	-	129000	■	GWP3331AL957	✓
1450	I	✓	90	5700	C5	10°	-	129000	■	GWP3331AM957	✓
1450	I	✓	90	5700	C6	8°	-	118000	■	GWP3331AN957	✓
1450	I	✓	80	5700	ELL	20°x80°	-	138000	■	GWP3331AA857	✓
1450	I	✓	80	5700	C1	40°	-	138000	■	GWP3331AF857	✓
1450	I	✓	80	5700	C2	30°	-	147000	■	GWP3331AG857	✓
1450	I	✓	80	5700	C3	20°	-	147000	■	GWP3331AH857	✓
1450	I	✓	80	5700	C4	15°	-	151000	■	GWP3331AL857	✓
1450	I	✓	80	5700	C5	10°	-	151000	■	GWP3331AM857	✓
1450	I	✓	80	5700	C6	8°	-	138000	■	GWP3331AN857	✓
1450	I	✓	80	4000	ELL	20°x80°	-	138000	■	GWP3331AA840	✓
1450	I	✓	80	4000	C1	40°	-	138000	■	GWP3331AF840	✓
1450	I	✓	80	4000	C2	30°	-	147000	■	GWP3331AG840	✓
1450	I	✓	80	4000	C3	20°	-	147000	■	GWP3331AH840	✓
1450	I	✓	80	4000	C4	15°	-	151000	■	GWP3331AL840	✓
1450	I	✓	80	4000	C5	10°	-	151000	■	GWP3331AM840	✓
1450	I	✓	80	4000	C6	8°	-	138000	■	GWP3331AN840	✓
1450	I	✓	70	5700	ELL	20°x80°	-	160000	■	GWP3331AA757	✓
1450	I	✓	70	5700	C1	40°	-	160000	■	GWP3331AF757	✓
1450	I	✓	70	5700	C2	30°	-	170000	■	GWP3331AG757	✓
1450	I	✓	70	5700	C3	20°	-	170000	■	GWP3331AH757	✓
1450	I	✓	70	5700	C4	15°	-	175000	■	GWP3331AL757	✓
1450	I	✓	70	5700	C5	10°	-	175000	■	GWP3331AM757	✓
1450	I	✓	70	5700	C6	8°	-	160000	■	GWP3331AN757	✓
1450	I	✓	70	4000	ELL	20°x80°	-	160000	■	GWP3331AA740	✓
1450	I	✓	70	4000	C1	40°	-	160000	■	GWP3331AF740	✓
1450	I	✓	70	4000	C2	30°	-	170000	■	GWP3331AG740	✓
1450	I	✓	70	4000	C3	20°	-	170000	■	GWP3331AH740	✓
1450	I	✓	70	4000	C4	15°	-	175000	■	GWP3331AL740	✓
1450	I	✓	70	4000	C5	10°	-	175000	■	GWP3331AM740	✓
1450	I	✓	70	4000	C6	8°	-	160000	■	GWP3331AN740	✓



STADIUM PRO 3M ASYMMETRIC

IP66 - IK08

LUMINAIRE WATTAGE (W)	CLASS	ENEC	CRI	KELVIN	OPTIC	BEAM ANGLE	LIGHTSOURCE LUMEN OUTPUT (lm)	LUMINAIRE LUMEN OUTPUT (lm)	COLOUR / FINISH	PART NUMBER	UKCA
Power LED - 3CH											
1450	I	✓	90	5700	A1	45°	-	114000	■	GWP3331AB957	✓
1450	I	✓	90	5700	A2	60°	-	110000	■	GWP3331AC957	✓
1450	I	✓	80	5700	A1	45°	-	133000	■	GWP3331AB857	✓
1450	I	✓	80	5700	A2	60°	-	128700	■	GWP3331AC857	✓
1450	I	✓	80	4000	A1	45°	-	133000	■	GWP3331AB840	✓
1450	I	✓	80	4000	A2	60°	-	128700	■	GWP3331AC840	✓
1450	I	✓	70	5700	A1	45°	-	153000	■	GWP3331AB757	✓
1450	I	✓	70	5700	A2	60°	-	149000	■	GWP3331AC757	✓
1450	I	✓	70	4000	A1	45°	-	153000	■	GWP3331AB740	✓
1450	I	✓	70	4000	A2	60°	-	149000	■	GWP3331AC740	✓



Control gear

DESCRIPTION	COLOR	PART NUMBER	UKCA
STADIUM PRO 3M			
Single driver 0-10 V 220-240 V		GWP30017	✓
Single driver DALI 220-240 V		GWP30015	✓
Driver box 0-10 V 220-240 V		GWP30035	✓
Driver box DALI 220-240 V		GWP30033	✓
Power supply unit DALI 220-400 V		GWP30031	✓
Power supply unit DMX 220-400 V		GWP30032	✓
Power supply unit connection kit		GWP30030	✓

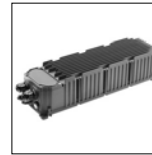

GWP30031
GWP30032

Optional accessories

DESCRIPTION	COLOR	PART NUMBER	UKCA
STADIUM PRO 3M			
Red Dot pointer support		GWP30004	✓
Anti-glare louvre for circular optic versions		GWP30002	✓
Visor for symmetric or circular optic versions		GWP30003	✓
Connector GW Connect 12 poles		GWP20004	✓
Power supply unit mounting bracket		GWP30001	✓
H07RN-F 12x1,5 mm ² cable - skein 50 m		GWP20005	✓
STADIUM PRO 3M /SYMM			
Replacement glass for symmetric optic versions		GWP30006	✓
STADIUM PRO 3M /ASYMM			
Replacement glass for asymmetric optic versions		GWP30009	✓



GWP30004

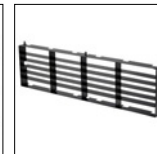

GWP30002



GWP30003



GWP30001

SPATIUM PRO 1M



Scan the QR-code for the latest information

■ Graphite grey / Graphite grey /

High-power outdoor LED floodlight suitable for the lighting of outdoor areas such as industrial perimeter areas, pedestrian areas and car parks

- The floodlight has a graphite grey finish with trivalent treatment for maximum resistance to oxidation and is equipped with an integrated 'self-cleaning' heat dissipation system
- The bracket is made in galvanised steel fixed to the module via screws
- The floodlight is available in the following colour temperatures 3,000K, 4,000K or 5,700K and colour rendering CRI>70 (SDCM 5 Step), CRI>80 (SDCM 3 Step)
- The range also includes 4 types of optics: circular 40°, symmetrical/elliptical optic, and 2 asymmetric optics
- The power supply unit, available in the DALI version can be oriented to optimise the heat dissipation depending on the orientation of the motor
- The floodlight is completed with an external power supply unit fixed to the back of the heatsink
- It is protected from surges up to 6 kV in differential mode and 10 kV in common mode
- The T.I.R.Ex.optic system developed by GEWISS with lenses in PMMA HT (high-transparency), gives complete control over the light beam, allowing for great flexibility for any project design, with high qualitative and quantitative performance
- Equipped with a venting and anti-condensation valve
- The orientation system is enabled by the goniometer integrated into the bracket, which facilitates the pointing phases during installation

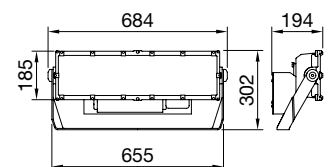

SPATIUM PRO 1M

Identifying and classifying our optics

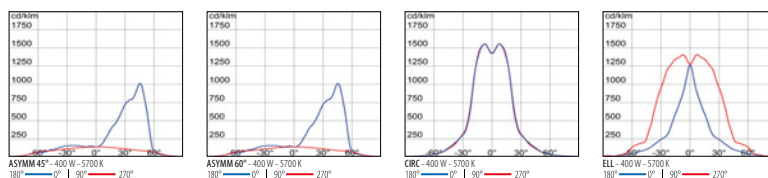

SPATIUM PRO 1M SYMMETRIC

IP66 - IK08



LUMINAIRE WATTAGE (W)	CLASS	ENEC	CRI	KELVIN	OPTIC	BEAM ANGLE	LIGHTSOURCE LUMEN OUTPUT (lm)	LUMINAIRE LUMEN OUTPUT (lm)	COLOUR / FINISH	PART NUMBER	UKCA
Power LED dimmable DALI - 220-240 V 50/60 Hz											
400	I	✓	80	5700	ELL	30°x80°	-	40000	■	GWP3133DA857	✓
400	I	✓	80	5700	C1	40°	-	42000	■	GWP3133DF857	✓
400	I	✓	80	4000	ELL	30°x80°	-	40000	■	GWP3133DA840	✓
400	I	✓	80	4000	C1	40°	-	42000	■	GWP3133DF840	✓
400	I	✓	80	3000	ELL	30°x80°	-	38500	■	GWP3133DA830	✓
400	I	✓	80	3000	C1	40°	-	41000	■	GWP3133DF830	✓
400	I	✓	70	5700	ELL	30°x80°	-	46500	■	GWP3133DA757	✓
400	I	✓	70	5700	C1	40°	-	49000	■	GWP3133DF757	✓
400	I	✓	70	4000	ELL	30°x80°	-	46500	■	GWP3133DA740	✓
400	I	✓	70	4000	C1	40°	-	49000	■	GWP3133DF740	✓
400	I	✓	70	3000	ELL	30°x80°	-	43500	■	GWP3133DA730	✓
400	I	✓	70	3000	C1	40°	-	46000	■	GWP3133DF730	✓

SPATIUM PRO 1M ASYMMETRIC

IP66 - IK08



LUMINAIRE WATTAGE (W)	CLASS	ENEC	CRI	KELVIN	OPTIC	BEAM ANGLE	LIGHTSOURCE LUMEN OUTPUT (lm)	LUMINAIRE LUMEN OUTPUT (lm)	COLOUR / FINISH	PART NUMBER	UKCA
Power LED dimmable DALI - 220-240 V 50/60 Hz											
400	I	✓	80	5700	A1	45°	-	40000	■	GWP3133DB857	✓
400	I	✓	80	5700	A2	60°	-	36500	■	GWP3133DC857	✓
400	I	✓	80	4000	A1	45°	-	40000	■	GWP3133DB840	✓
400	I	✓	80	4000	A2	60°	-	36500	■	GWP3133DC840	✓
400	I	✓	80	3000	A1	45°	-	39000	■	GWP3133DB830	✓
400	I	✓	80	3000	A2	60°	-	35500	■	GWP3133DC830	✓
400	I	✓	70	5700	A1	45°	-	46000	■	GWP3133DB757	✓
400	I	✓	70	5700	A2	60°	-	42500	■	GWP3133DC757	✓
400	I	✓	70	4000	A1	45°	-	46000	■	GWP3133DB740	✓
400	I	✓	70	4000	A2	60°	-	42500	■	GWP3133DC740	✓
400	I	✓	70	3000	A1	45°	-	44000	■	GWP3133DB730	✓
400	I	✓	70	3000	A2	60°	-	40000	■	GWP3133DC730	✓

Optional accessories

DESCRIPTION	COLOR	PART NUMBER	UKCA
SPATIUM PRO 1M			
Red Dot pointer support		GWP30004	✓
Anti-glare louvre for circular optic versions		GWP30002	✓
Visor for symmetric or circular optic versions		GWP30003	✓
3-way connection kit		GWP20113	✓
4-way connection kit		GWP20114	✓
SPATIUM PRO 1M /SYMM			
Replacement glass for symmetric optic versions		GWP30006	✓
SPATIUM PRO 1M /ASYMM			
Replacement glass for asymmetric optic versions		GWP30009	✓



GWP30004

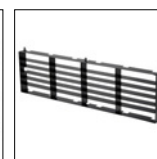

GWP30002



GWP30003

SPATIUM PRO 2M

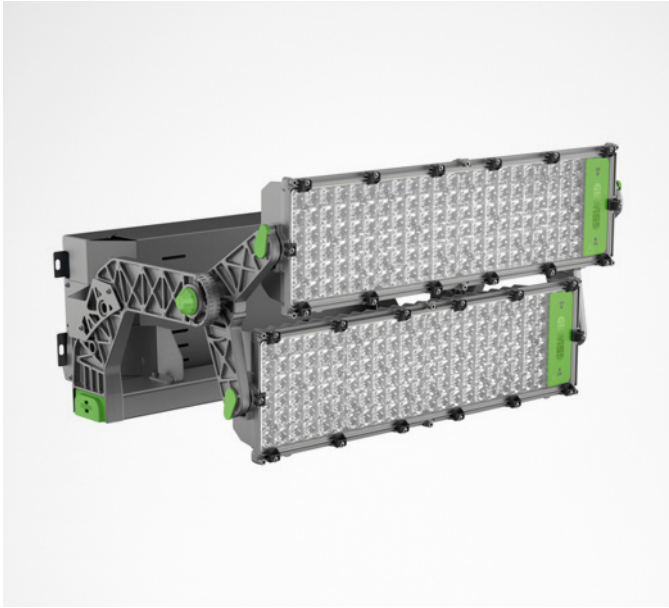

Scan the QR-code for the latest information

■ Graphite grey / Graphite grey /

High-power outdoor LED floodlight, suitable for lighting large areas and industrial zones

- The blocks are misaligned to allow for better thermal dissipation and increased system efficiency and longevity
- The floodlight has a graphite grey finish with trivalent treatment for maximum resistance to oxidation and is equipped with an integrated 'self-cleaning' heat dissipation system
- The floodlight is available in the following colour temperatures 3,000K, 4,000K or 5,700K and colour rendering CRI>70 (SDCM 5 Step), CRI>80 (SDCM 3 Step)
- The range also includes 4 types of optics: circular 40°, symmetrical/elliptical optic, and 2 asymmetric optics
- The system includes an external power supply unit installed on the bracket or remote in the DALI version
- The Power supply unit is for single-phase electric networks, protected from surges up to 6 kV in differential mode and 10 kV in common mode
- The T.I.R.Ex.optic system developed by GEWISS with lenses in PMMA HT (high-transparency), gives complete control over the light beam, allowing for great flexibility for any project design, with high qualitative and quantitative performance
- It consists of 2 modules, each with a bleed and anti-condensation valve, protected from accidental impact
- The rotation system between the brackets and optic modules is of a truncated-conical aluminium type, with an integrated goniometer in the bracket for easy control of orientation, and screw and grub screw fastening, which guarantees the secure fixing of each individual module over time

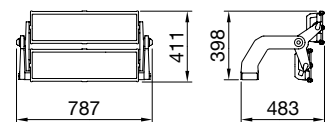

SPATIUM PRO 2M

Identifying and classifying our optics

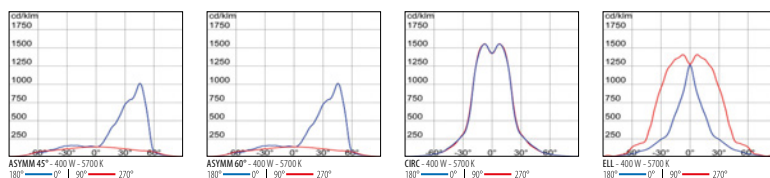

SPATIUM PRO 2M SYMMETRIC

IP66 - IK08

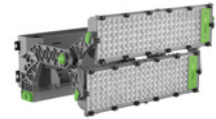

LUMINAIRE WATTAGE (W)	CLASS	ENEC	CRI	KELVIN	OPTIC	BEAM ANGLE	LIGHTSOURCE LUMEN OUTPUT (lm)	LUMINAIRE LUMEN OUTPUT (lm)	COLOUR / FINISH	PART NUMBER	UKCA
Power LED - 2CH											
800	I	✓	80	5700	ELL	30°x80°	-	80000	■	GWP3233AA857	✓
800	I	✓	80	5700	C1	40°	-	84000	■	GWP3233AF857	✓
800	I	✓	80	4000	ELL	30°x80°	-	80000	■	GWP3233AA840	✓
800	I	✓	80	4000	C1	40°	-	84000	■	GWP3233AF840	✓
800	I	✓	80	3000	ELL	30°x80°	-	77000	■	GWP3233AA830	✓
800	I	✓	80	3000	C1	40°	-	82000	■	GWP3233AF830	✓
800	I	✓	70	5700	ELL	30°x80°	-	93000	■	GWP3233AA757	✓
800	I	✓	70	5700	C1	40°	-	98000	■	GWP3233AF757	✓
800	I	✓	70	4000	ELL	30°x80°	-	93000	■	GWP3233AA740	✓
800	I	✓	70	4000	C1	40°	-	98000	■	GWP3233AF740	✓
800	I	✓	70	3000	ELL	30°x80°	-	87000	■	GWP3233AA730	✓
800	I	✓	70	3000	C1	40°	-	92000	■	GWP3233AF730	✓

SPATIUM PRO 2M ASYMMETRIC

IP66 - IK08



LUMINAIRE WATTAGE (W)	CLASS	ENEC	CRI	KELVIN	OPTIC	BEAM ANGLE	LIGHTSOURCE LUMEN OUTPUT (lm)	LUMINAIRE LUMEN OUTPUT (lm)	COLOUR / FINISH	PART NUMBER	UKCA
Power LED - 2CH											
800	I	✓	80	5700	A1	45°	-	80000	■	GWP3233AB857	✓
800	I	✓	80	5700	A2	60°	-	73000	■	GWP3233AC857	✓
800	I	✓	80	4000	A1	45°	-	80000	■	GWP3233AB840	✓
800	I	✓	80	4000	A2	60°	-	73000	■	GWP3233AC840	✓
800	I	✓	80	3000	A1	45°	-	78000	■	GWP3233AB830	✓
800	I	✓	80	3000	A2	60°	-	71000	■	GWP3233AC830	✓
800	I	✓	70	5700	A1	45°	-	92000	■	GWP3233AB757	✓
800	I	✓	70	5700	A2	60°	-	85000	■	GWP3233AC757	✓
800	I	✓	70	4000	A1	45°	-	92000	■	GWP3233AB740	✓
800	I	✓	70	4000	A2	60°	-	85000	■	GWP3233AC740	✓
800	I	✓	70	3000	A1	45°	-	88000	■	GWP3233AB730	✓
800	I	✓	70	3000	A2	60°	-	80000	■	GWP3233AC730	✓

Control gear

DESCRIPTION	COLOR	PART NUMBER	UKCA
SPATIUM PRO 2M			
Single driver 0-10 V 220-240 V		GWP30018	✓
Single driver DALI 220-240 V		GWP30016	✓
Driver box 0-10 V 220-240 V		GWP30026	✓
Driver box DALI 220-240 V		GWP30024	✓

Optional accessories

DESCRIPTION	COLOR	PART NUMBER	UKCA
STADIUM PRO 2M			
Red Dot pointer support		GWP30004	✓
Anti-glare louvre for circular optic versions		GWP30002	✓
Visor for symmetric or circular optic versions		GWP30003	✓
Connector GW Connect 7 poles		GWP30008	✓
Power supply unit mounting bracket		GWP30007	✓
STADIUM PRO 2M /SYMM			
Replacement glass for symmetric optic versions		GWP30006	✓
STADIUM PRO 2M /ASYMM			
Replacement glass for asymmetric optic versions		GWP30009	✓



GWP30004

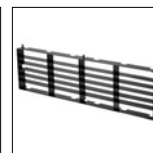

GWP30002



GWP30003

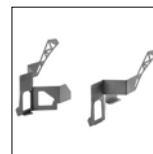

GWP30007

SPATIUM PRO 3M

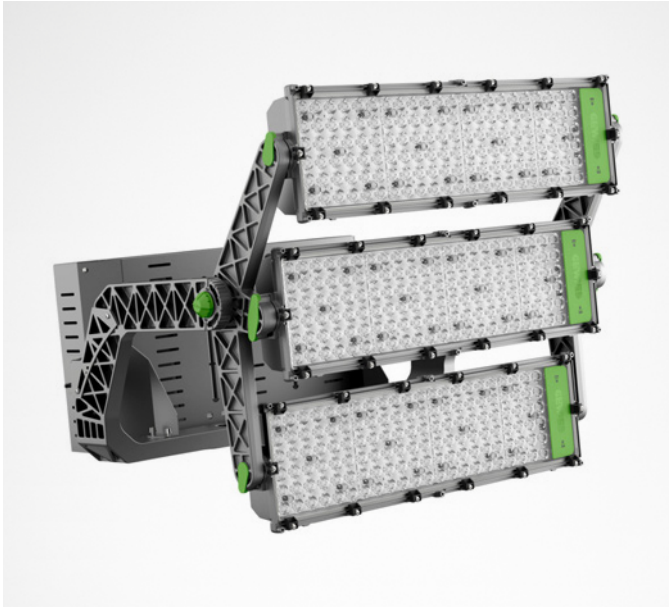

Scan the QR-code for the latest information

■ Graphite grey / Graphite grey /

High-power LED floodlight for outdoor lighting in large areas, such as car parks, ports, large industrial areas, airports and inland terminals

- The blocks are offset to allow better heat dissipation and increase the efficiency and lifespan of the system
- The spotlight has a graphite grey finish with trivalent treatment for maximum resistance to oxidation and is equipped with an integrated "self-cleaning" heat dissipation system
- The floodlight is available in 3,000K, 4,000K or 5,700K colour temperatures and CRI>70 (5-Step SDCM) or CRI>80 (3-Step SDCM) colour rendering
- The range also includes 4 types of optics: 40° circular, a symmetrical/elliptical optic and 2 asymmetrical optics
- The system's external power supply unit is fixed to the edge of the bracket or remote, in the DALI version
- The power supply is for single-phase electrical grids, it is immune to surges of up to 6 kV in RCCB mode and 10 kV in common mode
- The T.I.R.Ex optical system developed by GEWISS, with high transparency PMMA HT lenses, gives total control over the light beam, providing wide flexibility in the design environment, with high qualitative and quantitative performance
- It consists of three modules, each with a ventilation and anti-condensation valve, protected from accidental impacts
- The rotation device between the bracket and the optical modules is an aluminium truncated cone-shaped system with a goniometer built into the bracket for easy orientation control and fixing with bolts and grub screws to ensure the stability of each individual module over time

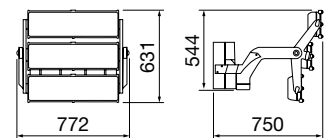

SPATIUM PRO 3M

Identifying and classifying our optics

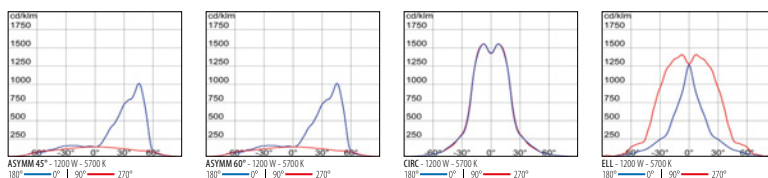

SPATIUM PRO 3M SYMMETRIC

IP66 - IK08

LUMINAIRE WATTAGE (W)	CLASS	ENEC	CRI	KELVIN	OPTIC	BEAM ANGLE	LIGHTSOURCE LUMEN OUTPUT (lm)	LUMINAIRE LUMEN OUTPUT (lm)	COLOUR / FINISH	PART NUMBER	UKCA
Power LED - 3CH											
1200	I	✓	80	5700	ELL	30°x80°	-	121000	■	GWP3333AA857	✓
1200	I	✓	80	5700	C1	40°	-	127000	■	GWP3333AF857	✓
1200	I	✓	80	4000	ELL	30°x80°	-	121000	■	GWP3333AA840	✓
1200	I	✓	80	4000	C1	40°	-	127000	■	GWP3333AF840	✓
1200	I	✓	80	3000	ELL	30°x80°	-	116000	■	GWP3333AA830	✓
1200	I	✓	80	3000	C1	40°	-	123000	■	GWP3333AF830	✓
1200	I	✓	70	5700	ELL	30°x80°	-	139500	■	GWP3333AA757	✓
1200	I	✓	70	5700	C1	40°	-	147000	■	GWP3333AF757	✓
1200	I	✓	70	4000	ELL	30°x80°	-	139500	■	GWP3333AA740	✓
1200	I	✓	70	4000	C1	40°	-	147000	■	GWP3333AF740	✓
1200	I	✓	70	3000	ELL	30°x80°	-	131000	■	GWP3333AA730	✓
1200	I	✓	70	3000	C1	40°	-	138000	■	GWP3333AF730	✓

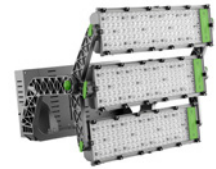

SPATIUM PRO 3M ASYMMETRIC

IP66 - IK08

LUMINAIRE WATTAGE (W)	CLASS	ENEC	CRI	KELVIN	OPTIC	BEAM ANGLE	LIGHTSOURCE LUMEN OUTPUT (lm)	LUMINAIRE LUMEN OUTPUT (lm)	COLOUR / FINISH	PART NUMBER	UKCA
Power LED - 3CH											
1200	I	✓	80	5700	A1	45°	-	119000	■	GWP3333AB857	✓
1200	I	✓	80	5700	A2	60°	-	110000	■	GWP3333AC857	✓
1200	I	✓	80	4000	A1	45°	-	119000	■	GWP3333AB840	✓
1200	I	✓	80	4000	A2	60°	-	110000	■	GWP3333AC840	✓
1200	I	✓	80	3000	A1	45°	-	115000	■	GWP3333AB830	✓
1200	I	✓	80	3000	A2	60°	-	106000	■	GWP3333AC830	✓
1200	I	✓	70	5700	A1	45°	-	138000	■	GWP3333AB757	✓
1200	I	✓	70	5700	A2	60°	-	127500	■	GWP3333AC757	✓
1200	I	✓	70	4000	A1	45°	-	138000	■	GWP3333AB740	✓
1200	I	✓	70	4000	A2	60°	-	127500	■	GWP3333AC740	✓
1200	I	✓	70	3000	A1	45°	-	130000	■	GWP3333AB730	✓
1200	I	✓	70	3000	A2	60°	-	120000	■	GWP3333AC730	✓

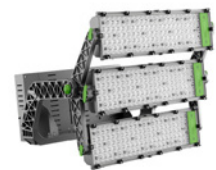

Control gear

DESCRIPTION	COLOR	PART NUMBER	UKCA
SPATIUM PRO 3M			
Single driver 0-10 V 220-240 V		GWP30018	✓
Single driver DALI 220-240 V		GWP30016	✓
Driver box 0-10 V 220-240 V		GWP30036	✓
Driver box DALI 220-240 V		GWP30034	✓



GWP30034

Optional accessories

DESCRIPTION	COLOR	PART NUMBER	UKCA
SPATIUM PRO 3M			
Red Dot pointer support		GWP30004	✓
Anti-glare louvre for circular optic versions		GWP30002	✓
Visor for symmetric or circular optic versions		GWP30003	✓
Power supply unit mounting bracket		GWP30005	✓
SPATIUM PRO 3M /SYMM			
Replacement glass for symmetric optic versions		GWP30006	✓
SPATIUM PRO 3M /ASYMM			
Replacement glass for asymmetric optic versions		GWP30009	✓



GWP30004

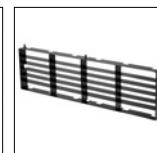

GWP30002



GWP30003

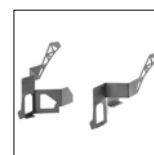

GWP30005

Urban and Street



Avenida de Andalucía - Málaga - Spain

A custom-made lighting solution for each urban area: streets, car parks, squares, green areas, playgrounds, bridges, and pedestrian streets. We create versatile urban lighting systems that combine collective and individual interests. We want to offer urban spaces a new identity and improve the perception of those who live in and use them.



URBAN [O3]



Scan the QR-code for the latest information

■ Graphite grey / Graphite grey /

Urban lighting device in die-cast aluminum EN AB 46100

- Equipped with lateral ventilation system made in technopolymer
- Powder poliester coated after epoxy surface treatment and phosphochromating process
- Modular LED engines (2-4) with extruded aluminum heat sink
- Holding plate in PC
- Double 2-pole safety switch for 2.5 mm² wires
- Internal wiring with UG4G4 1mm² wires
- Equipped with PMMA lenses
- Anti-aging silicone gasket
- External screws in stainless steel AISI 316
- Recessed handle closing system and steel holding cable
- It can be used up to 50°C of ambient temperature but with reduced currents as indicated in the instruction manual
- Side fixing for Ø60mm bracket in die-cast aluminum with possibility of ±15° inclination adjustment



Municipality - Bellinzona - Switzerland

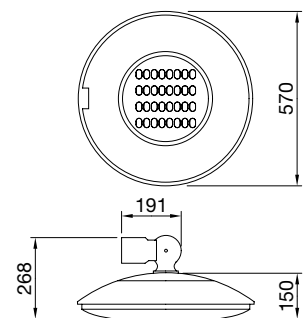

URBAN [O3]

Identifying and classifying our optics

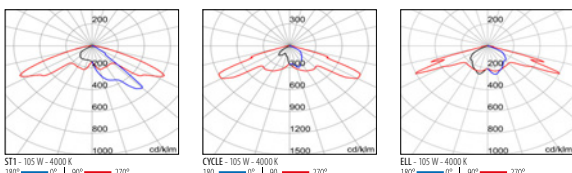

URBAN [O3] ST1

IP66 - IK08

LUMINAIRE WATTAGE [W]	CLASS	ENEC	CRI	KELVIN	OPTIC	BEAM ANGLE	LIGHTSOURCE LUMEN OUTPUT [lm]	LUMINAIRE LUMEN OUTPUT [lm]	COLOUR / FINISH	PART NUMBER	UKCA
Power LED automatic power reduction, bipower with self-learning - 220-240 V 50/60 Hz											
105	II	-	70	4000	ST1	-	-	11240	■	GW87628	✓
81	II	-	70	4000	ST1	-	-	8590	■	GW87627	✓
Power LED dimmable 1-10 V 220-240 V 50/60 Hz											
105	II	-	70	4000	ST1	-	-	11240	■	GW87608	✓
81	II	-	70	4000	ST1	-	-	8590	■	GW87607	✓



URBAN [O3] ELLIPTICAL

IP66 - IK08

LUMINAIRE WATTAGE [W]	CLASS	ENEC	CRI	KELVIN	OPTIC	BEAM ANGLE	LIGHTSOURCE LUMEN OUTPUT [lm]	LUMINAIRE LUMEN OUTPUT [lm]	COLOUR / FINISH	PART NUMBER	UKCA
Power LED automatic power reduction, bipower with self-learning - 220-240 V 50/60 Hz											
105	II	-	70	4000	ELL	-	-	11240	■	GWS7278	✓
81	II	-	70	4000	ELL	-	-	8590	■	GWS7277	✓
Power LED dimmable 1-10 V 220-240 V 50/60 Hz											
105	II	-	70	4000	ELL	-	-	11240	■	GWS7258	✓
81	II	-	70	4000	ELL	-	-	8590	■	GWS7257	✓



URBAN [O3] CYCLE

IP66 - IK08

LUMINAIRE WATTAGE [W]	CLASS	ENEC	CRI	KELVIN	OPTIC	BEAM ANGLE	LIGHTSOURCE LUMEN OUTPUT [lm]	LUMINAIRE LUMEN OUTPUT [lm]	COLOUR / FINISH	PART NUMBER	UKCA
Power LED automatic power reduction, bipower with self-learning - 220-240 V 50/60 Hz											
105	II	-	70	4000	CYCLE	-	-	10560	■	GWS7228	✓
81	II	-	70	4000	CYCLE	-	-	8060	■	GWS7227	✓
Power LED dimmable 1-10 V 220-240 V 50/60 Hz											
105	II	-	70	4000	CYCLE	-	-	10560	■	GWS7208	✓
81	II	-	70	4000	CYCLE	-	-	8060	■	GWS7207	✓



Optional accessories

DESCRIPTION	COLOR	PART NUMBER	UKCA
URBAN [O3]			
Single pole head bracket 0.4 m - graphite grey		GW87881	✓
Double pole head bracket 0.8 m - graphite grey		GW87882	✓
Single intermediate bracket 0.4 m - graphite grey		GW87883	✓
Painted cylindrical pole h = 4 m - graphite grey		GW87691	✓
Painted cylindrical pole h = 4 m - BlueGreen		GW87691B	✓
Painted cylindrical pole h = 4.5 m - graphite grey		GW87692	✓
Painted cylindrical pole h = 4.5 m - BlueGreen		GW87692B	✓



GW87881



GW87882



GW87883

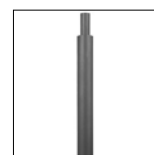

GW87691

ROAD [5] MINI



Urban street - Giubiasco - Italy

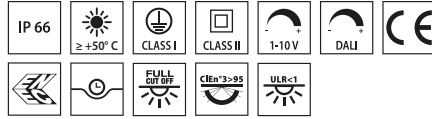

Scan the QR-code for the latest information

■ GR-RAL9006 / Grey RAL9006 /

Street lighting device with cover, frame, and pole attachment in EN AB 46100 die-cast aluminium with low copper content

- Polyester powder coated
- High-power LED
- Printed Circuit Board (PCB) in metal core
- Common mode surge protection up to 10kV
- With safety switch
- Cable plate in PA6.6 + glass fiber
- Cable input via PG13.5 cable gland
- High reflective aluminium optical system
- Tempered flat glass with 4mm thickness
- Opening and closing system with integrated front handle
- It can be used up to 50°C of ambient temperature but with reduced currents as indicated in the instruction manual
- Suitable for installation both on top of the pole and offset with 5° pitch adjustment

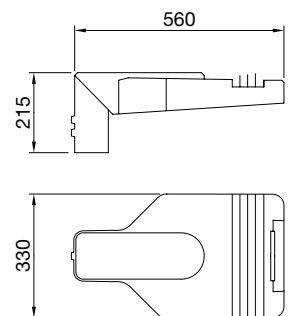

ROAD [5]
MINI

Identifying and classifying our optics

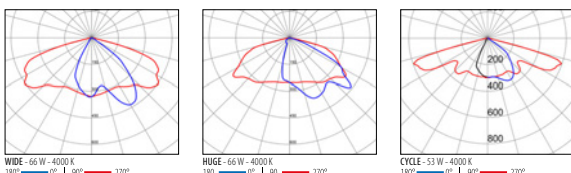

ROAD [5] MINI 1X3 LED WIDE

IP66 - IK08



LUMINAIRE WATTAGE (W)	CLASS	ENEC	CRI	KELVIN	OPTIC	BEAM ANGLE	LIGHTSOURCE LUMEN OUTPUT (lm)	LUMINAIRE LUMEN OUTPUT (lm)	COLOUR / FINISH	PART NUMBER	UKCA
Power LED 220-240 V 50/60 Hz											
37	II	✓	70	4000	WIDE	-	-	5000	■	GWR5211	✓
37	II	✓	70	3000	WIDE	-	-	4300	■	GWR521130K	✓
26	II	✓	70	4000	WIDE	-	-	3700	■	GWR5271	✓
26	II	✓	70	3000	WIDE	-	-	3200	■	GWR527130K	✓
13	II	✓	70	4000	WIDE	-	-	2000	■	GWR5231	✓
13	II	✓	70	3000	WIDE	-	-	1700	■	GWR523130K	✓
37	I	✓	70	4000	WIDE	-	-	5000	■	GWR5711	✓
37	I	✓	70	3000	WIDE	-	-	4300	■	GWR571130K	✓
26	I	✓	70	4000	WIDE	-	-	3700	■	GWR5771	✓
26	I	✓	70	3000	WIDE	-	-	3200	■	GWR577130K	✓
13	I	✓	70	4000	WIDE	-	-	2000	■	GWR5731	✓
13	I	✓	70	3000	WIDE	-	-	1700	■	GWR573130K	✓
Power LED automatic power reduction, bipower with self-learning - 220-240 V 50/60 Hz											
37	II	✓	70	4000	WIDE	-	-	5000	■	GWR5211B	✓
37	II	✓	70	3000	WIDE	-	-	4300	■	GWR5211B30K	✓
26	II	✓	70	4000	WIDE	-	-	3700	■	GWR5271B	✓
26	II	✓	70	3000	WIDE	-	-	3200	■	GWR5271B30K	✓
19	II	✓	70	4000	WIDE	-	-	2700	■	GWR5251B	✓
19	II	✓	70	3000	WIDE	-	-	2400	■	GWR5251B30K	✓
37	I	✓	70	4000	WIDE	-	-	5000	■	GWR5711B	✓
37	I	✓	70	3000	WIDE	-	-	4300	■	GWR5711B30K	✓
26	I	✓	70	4000	WIDE	-	-	3700	■	GWR5771B	✓
26	I	✓	70	3000	WIDE	-	-	3200	■	GWR5771B30K	✓
Power LED dimmable DALI - 220-240 V 50/60 Hz											
37	I	✓	70	4000	WIDE	-	-	5000	■	GWR5711V	✓
Power LED dimmable DALI (5 Step) - 220-240 V 50/60 Hz											
37	II	✓	70	4000	WIDE	-	-	5000	■	GWR5211V	✓
26	II	✓	70	4000	WIDE	-	-	3700	■	GWR5271V	✓
13	II	✓	70	4000	WIDE	-	-	2000	■	GWR5231V	✓
Power LED dimmable 1-10 V 220-240 V 50/60 Hz											
37	II	✓	70	4000	WIDE	-	-	5000	■	GWR5211M	✓
37	II	✓	70	3000	WIDE	-	-	4300	■	GWR5211M30K	✓
26	II	✓	70	4000	WIDE	-	-	3700	■	GWR5271M	✓
26	II	✓	70	3000	WIDE	-	-	3200	■	GWR5271M30K	✓
19	II	✓	70	4000	WIDE	-	-	2700	■	GWR5251M	✓
37	I	✓	70	4000	WIDE	-	-	5000	■	GWR5711M	✓
37	I	✓	70	3000	WIDE	-	-	4300	■	GWR5711M30K	✓
26	I	✓	70	4000	WIDE	-	-	3700	■	GWR5771M	✓
26	I	✓	70	3000	WIDE	-	-	3200	■	GWR5771M30K	✓

ROAD [5] MINI 1X3 LED HUGE

IP66 - IK08

LUMINAIRE WATTAGE [W]	CLASS	ENEC	CRI	KELVIN	OPTIC	BEAM ANGLE	LIGHTSOURCE LUMEN OUTPUT [lm]	LUMINAIRE LUMEN OUTPUT [lm]	COLOUR / FINISH	PART NUMBER	UKCA
Power LED 220-240 V 50/60 Hz											
37	II	✓	70	4000	HUGE	-	-	4700	■	GWR5111	✓
37	II	✓	70	3000	HUGE	-	-	4100	■	GWR511130K	✓
26	II	✓	70	4000	HUGE	-	-	3500	■	GWR5171	✓
26	II	✓	70	3000	HUGE	-	-	3000	■	GWR517130K	✓
13	II	✓	70	4000	HUGE	-	-	1900	■	GWR5131	✓
13	II	✓	70	3000	HUGE	-	-	1600	■	GWR513130K	✓
37	I	✓	70	4000	HUGE	-	-	4700	■	GWR5611	✓
37	I	✓	70	3000	HUGE	-	-	4100	■	GWR561130K	✓
26	I	✓	70	4000	HUGE	-	-	3500	■	GWR5671	✓
26	I	✓	70	3000	HUGE	-	-	3000	■	GWR567130K	✓
13	I	✓	70	4000	HUGE	-	-	1900	■	GWR5631	✓
13	I	✓	70	3000	HUGE	-	-	1600	■	GWR563130K	✓
Power LED automatic power reduction, bipower with self-learning - 220-240 V 50/60 Hz											
37	II	✓	70	4000	HUGE	-	-	4700	■	GWR5111B	✓
37	II	✓	70	3000	HUGE	-	-	4100	■	GWR5111B30K	✓
26	II	✓	70	4000	HUGE	-	-	3500	■	GWR5171B	✓
26	II	✓	70	3000	HUGE	-	-	3000	■	GWR5171B30K	✓
19	II	✓	70	4000	HUGE	-	-	2600	■	GWR5151B	✓
37	I	✓	70	4000	HUGE	-	-	4700	■	GWR5611B	✓
37	I	✓	70	3000	HUGE	-	-	4100	■	GWR5611B30K	✓
26	I	✓	70	4000	HUGE	-	-	3500	■	GWR5671B	✓
26	I	✓	70	3000	HUGE	-	-	3000	■	GWR5671B30K	✓
Power LED dimmable DALI (5 Step) - 220-240 V 50/60 Hz											
37	II	✓	70	4000	HUGE	-	-	4700	■	GWR5111V	✓
26	II	✓	70	4000	HUGE	-	-	3500	■	GWR5171V	✓
13	II	✓	70	4000	HUGE	-	-	1900	■	GWR5131V	✓
Power LED dimmable 1-10 V 220-240 V 50/60 Hz											
37	II	✓	70	4000	HUGE	-	-	4700	■	GWR5111M	✓
37	II	✓	70	3000	HUGE	-	-	4100	■	GWR5111M30K	✓
26	II	✓	70	4000	HUGE	-	-	3500	■	GWR5171M	✓
26	II	✓	70	3000	HUGE	-	-	3000	■	GWR5171M30K	✓
19	II	✓	70	4000	HUGE	-	-	2600	■	GWR5151M	✓
37	I	✓	70	4000	HUGE	-	-	4700	■	GWR5611M	✓
37	I	✓	70	3000	HUGE	-	-	4100	■	GWR5611M30K	✓
26	I	✓	70	4000	HUGE	-	-	3500	■	GWR5671M	✓
26	I	✓	70	3000	HUGE	-	-	3000	■	GWR5671M30K	✓



ROAD [5] MINI 1X3 LED CYCLE

IP66 - IK08

LUMINAIRE WATTAGE [W]	CLASS	ENEC	CRI	KELVIN	OPTIC	BEAM ANGLE	LIGHTSOURCE LUMEN OUTPUT [lm]	LUMINAIRE LUMEN OUTPUT [lm]	COLOUR / FINISH	PART NUMBER	UKCA
Power LED dimmable DALI (5 Step) - 220-240 V 50/60 Hz											
27	II	✓	70	4000	CYCLE	-	-	1900	■	GWR5371MV	✓
Power LED dimmable 1-10 V 220-240 V 50/60 Hz											
27	II	✓	70	4000	CYCLE	-	-	1900	■	GWR5371M	✓
27	II	✓	70	3000	CYCLE	-	-	1900	■	GWR5371M30K	✓
27	I	✓	70	4000	CYCLE	-	-	1900	■	GWR5871M	✓
27	I	✓	70	3000	CYCLE	-	-	1900	■	GWR5871M30K	✓



ROAD [5] MINI 2X3 LED WIDE

IP66 - IK08



LUMINAIRE WATTAGE (W)	CLASS	ENEC	CRI	KELVIN	OPTIC	BEAM ANGLE	LIGHTSOURCE LUMEN OUTPUT (lm)	LUMINAIRE LUMEN OUTPUT (lm)	COLOUR / FINISH	PART NUMBER	UKCA
Power LED 220-240 V 50/60 Hz											
66	II	✓	70	4000	WIDE	-	-	9100	■	GWR5212	✓
66	II	✓	70	3000	WIDE	-	-	7900	■	GWR521230K	✓
51	II	✓	70	4000	WIDE	-	-	7300	■	GWR5272	✓
51	II	✓	70	3000	WIDE	-	-	6400	■	GWR527230K	✓
66	I	✓	70	4000	WIDE	-	-	9100	■	GWR5712	✓
66	I	✓	70	3000	WIDE	-	-	7900	■	GWR571230K	✓
51	I	✓	70	4000	WIDE	-	-	7300	■	GWR5772	✓
51	I	✓	70	3000	WIDE	-	-	6400	■	GWR577230K	✓
Power LED automatic power reduction, bipower with self-learning - 220-240 V 50/60 Hz											
74	II	✓	70	4000	WIDE	-	-	9900	■	GWR5212B	✓
74	II	✓	70	3000	WIDE	-	-	8600	■	GWR5212B30K	✓
51	II	✓	70	4000	WIDE	-	-	7300	■	GWR5272B	✓
51	II	✓	70	3000	WIDE	-	-	6400	■	GWR5272B30K	✓
37	II	✓	70	4000	WIDE	-	-	5400	■	GWR5252B	✓
74	I	✓	70	4000	WIDE	-	-	9900	■	GWR5712B	✓
74	I	✓	70	3000	WIDE	-	-	8600	■	GWR5712B30K	✓
51	I	✓	70	4000	WIDE	-	-	7300	■	GWR5772B	✓
51	I	✓	70	3000	WIDE	-	-	6400	■	GWR5772B30K	✓
Power LED dimmable DALI - 220-240 V 50/60 Hz											
37	II	✓	70	4000	WIDE	-	-	5400	■	GWR5252D	✓
37	II	✓	70	3000	WIDE	-	-	4700	■	GWR5252D30K	✓
74	I	✓	70	4000	WIDE	-	-	9900	■	GWR5712V	✓
Power LED dimmable DALI (5 Step) - 220-240 V 50/60 Hz											
74	II	✓	70	4000	WIDE	-	-	9900	■	GWR5212V	✓
74	II	✓	70	3000	WIDE	-	-	8600	■	GWR5212V30K	✓
51	II	✓	70	4000	WIDE	-	-	7300	■	GWR5272V	✓
Power LED dimmable 1-10 V 220-240 V 50/60 Hz											
74	II	✓	70	4000	WIDE	-	-	9900	■	GWR5212M	✓
74	II	✓	70	3000	WIDE	-	-	8600	■	GWR5212M30K	✓
51	II	✓	70	4000	WIDE	-	-	7300	■	GWR5272M	✓
51	II	✓	70	3000	WIDE	-	-	6400	■	GWR5272M30K	✓
37	II	✓	70	4000	WIDE	-	-	5400	■	GWR5252M	✓
37	II	✓	70	3000	WIDE	-	-	4700	■	GWR5252M30K	✓
74	I	✓	70	4000	WIDE	-	-	9900	■	GWR5712M	✓
74	I	✓	70	3000	WIDE	-	-	8600	■	GWR5712M30K	✓
51	I	✓	70	4000	WIDE	-	-	7300	■	GWR5772M	✓
51	I	✓	70	3000	WIDE	-	-	6400	■	GWR5772M30K	✓

ROAD [5] MINI 2X3 LED HUGE

IP66 - IK08

LUMINAIRE WATTAGE (W)	CLASS	ENEC	CRI	KELVIN	OPTIC	BEAM ANGLE	LIGHTSOURCE LUMEN OUTPUT (lm)	LUMINAIRE LUMEN OUTPUT (lm)	COLOUR / FINISH	PART NUMBER	UKCA
Power LED 220-240 V 50/60 Hz											
66	II	✓	70	4000	HUGE	-	-	8600	■	GWR5112	✓
66	II	✓	70	3000	HUGE	-	-	7400	■	GWR511230K	✓
51	II	✓	70	4000	HUGE	-	-	6900	■	GWR5172	✓
51	II	✓	70	3000	HUGE	-	-	6000	■	GWR517230K	✓
66	I	✓	70	4000	HUGE	-	-	8600	■	GWR5612	✓
66	I	✓	70	3000	HUGE	-	-	7400	■	GWR561230K	✓
51	I	✓	70	4000	HUGE	-	-	6900	■	GWR5672	✓
51	I	✓	70	3000	HUGE	-	-	6000	■	GWR567230K	✓

Power LED automatic power reduction, bipower with self-learning - 220-240 V 50/60 Hz

74	II	✓	70	4000	HUGE	-	-	9300	■	GWR5112B	✓
74	II	✓	70	3000	HUGE	-	-	8100	■	GWR5112B30K	✓
51	II	✓	70	4000	HUGE	-	-	6900	■	GWR5172B	✓
51	II	✓	70	3000	HUGE	-	-	6000	■	GWR5172B30K	✓
37	II	✓	70	4000	HUGE	-	-	5100	■	GWR5152B	✓
74	I	✓	70	4000	HUGE	-	-	9300	■	GWR5612B	✓
74	I	✓	70	3000	HUGE	-	-	8100	■	GWR5612B30K	✓
51	I	✓	70	4000	HUGE	-	-	6900	■	GWR5672B	✓
51	I	✓	70	3000	HUGE	-	-	6000	■	GWR5672B30K	✓

Power LED dimmable DALI (5 Step) - 220-240 V 50/60 Hz

74	II	✓	70	4000	HUGE	-	-	9300	■	GWR5112V	✓
51	II	✓	70	4000	HUGE	-	-	6900	■	GWR5172V	✓

Power LED dimmable 1-10 V 220-240 V 50/60 Hz

74	II	✓	70	4000	HUGE	-	-	9300	■	GWR5112M	✓
74	II	✓	70	3000	HUGE	-	-	8100	■	GWR5112M30K	✓
51	II	✓	70	4000	HUGE	-	-	6900	■	GWR5172M	✓
51	II	✓	70	3000	HUGE	-	-	6000	■	GWR5172M30K	✓
37	II	✓	70	4000	HUGE	-	-	5100	■	GWR5152M	✓
74	I	✓	70	4000	HUGE	-	-	9300	■	GWR5612M	✓
74	I	✓	70	3000	HUGE	-	-	8100	■	GWR5612M30K	✓
51	I	✓	70	4000	HUGE	-	-	6900	■	GWR5672M	✓
51	I	✓	70	3000	HUGE	-	-	6000	■	GWR5672M30K	✓



ROAD [5] MINI 2X3 LED CYCLE

IP66 - IK08

LUMINAIRE WATTAGE (W)	CLASS	ENEC	CRI	KELVIN	OPTIC	BEAM ANGLE	LIGHTSOURCE LUMEN OUTPUT (lm)	LUMINAIRE LUMEN OUTPUT (lm)	COLOUR / FINISH	PART NUMBER	UKCA
Power LED dimmable DALI (5 Step) - 220-240 V 50/60 Hz											
53	II	✓	70	4000	CYCLE	-	-	3800	■	GWR5372MV	✓
Power LED dimmable 1-10 V 220-240 V 50/60 Hz											
53	II	✓	70	4000	CYCLE	-	-	3800	■	GWR5372M	✓
53	II	✓	70	3000	CYCLE	-	-	3800	■	GWR5372M30K	✓
53	I	✓	70	4000	CYCLE	-	-	3800	■	GWR5872M	✓
53	I	✓	70	3000	CYCLE	-	-	3800	■	GWR5872M30K	✓



Optional accessories

DESCRIPTION	COLOR	PART NUMBER	UKCA
ROAD [5] MINI			
Visor - graphite grey		GWR5191	✓
Wall-mounting bracket 150x160x290 mm - graphite grey		GW86167	✓
Single pole head bracket 1 m - graphite grey		GW87581	✓
Double pole head bracket 1+1 m - graphite grey		GW87582	✓
Short bracket 0.5 m - graphite grey		GW87587	✓
Long bracket 1 m - graphite grey		GW87586	✓
Conical pole painted h = 5.5 m - graphite grey		GW84096	✓
Conical pole painted h = 6.8 m - graphite grey		GW87591	✓
Conical pole painted h = 7.8 m - graphite grey		GW84097	✓
Conical pole painted h = 8.8 m - graphite grey		GW87592	✓
Conical pole painted h = 9.8 m - graphite grey		GW87593	✓



GWR5191

GW86167

GW87581



GW87582

GW87587

GW87586



GW84096

ROAD [5] MEDIUM

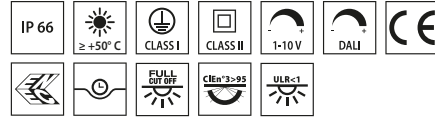

Scan the QR-code for the latest information

■ GR-RAL9006 / Grey RAL9006 /

Street lighting device with cover, frame, and pole attachment in EN AB 46100 die-cast aluminium with low copper content

- Polyester powder coated
- High-power LED
- Printed Circuit Board (PCB) in metal core
- Common mode surge protection up to 10kV
- With safety switch
- Cable plate in PA6.6 + glass fiber
- Cable input via PG13.5 cable gland
- High reflective aluminium optical system
- Tempered flat glass with 4mm thickness
- Opening and closing system with integrated front handle
- It can be used up to 50°C of ambient temperature but with reduced currents as indicated in the instruction manual
- Suitable for installation both on top of the pole and offset with 5° pitch adjustment



Urban street - Giubiasco - Italy

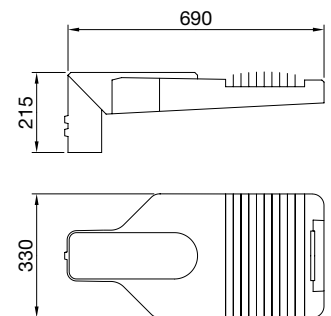

ROAD [5]
MEDIUM

Identifying and classifying our optics

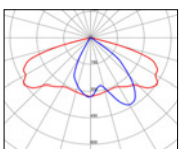

WIDE - 186 W - 4000 K
180° — 0° | 90° — 270°

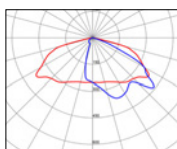

HURGE - 186 W - 4000 K
180° — 0° | 90° — 270°

ROAD [5] MEDIUM 3X3 LED WIDE

IP66 - IK08



LUMINAIRE WATTAGE (W)	CLASS	ENEC	CRI	KELVIN	OPTIC	BEAM ANGLE	LIGHTSOURCE LUMEN OUTPUT (lm)	LUMINAIRE LUMEN OUTPUT (lm)	COLOUR / FINISH	PART NUMBER	UKCA
Power LED 220-240 V 50/60 Hz											
111	II	✓	70	4000	WIDE	-	-	14800	■	GWR5213	✓
111	II	✓	70	3000	WIDE	-	-	12800	■	GWR521330K	✓
77	II	✓	70	4000	WIDE	-	-	11000	■	GWR5273	✓
77	II	✓	70	3000	WIDE	-	-	9500	■	GWR527330K	✓
111	I	✓	70	4000	WIDE	-	-	14800	■	GWR5713	✓
111	I	✓	70	3000	WIDE	-	-	12800	■	GWR571330K	✓
77	I	✓	70	4000	WIDE	-	-	11000	■	GWR5773	✓
77	I	✓	70	3000	WIDE	-	-	9500	■	GWR577330K	✓
Power LED automatic power reduction, bipower with self-learning - 220-240 V 50/60 Hz											
111	II	✓	70	4000	WIDE	-	-	14800	■	GWR5213B	✓
111	II	✓	70	3000	WIDE	-	-	12800	■	GWR5213B30K	✓
77	II	✓	70	4000	WIDE	-	-	11000	■	GWR5273B	✓
77	II	✓	70	3000	WIDE	-	-	9500	■	GWR5273B30K	✓
55	II	✓	70	4000	WIDE	-	-	8100	■	GWR5253B	✓
111	I	✓	70	4000	WIDE	-	-	14800	■	GWR5713B	✓
111	I	✓	70	3000	WIDE	-	-	12800	■	GWR5713B30K	✓
77	I	✓	70	4000	WIDE	-	-	11000	■	GWR5773B	✓
77	I	✓	70	3000	WIDE	-	-	9500	■	GWR5773B30K	✓
Power LED dimmable DALI - 220-240 V 50/60 Hz											
55	II	✓	70	4000	WIDE	-	-	8100	■	GWR5253D	✓
55	II	✓	70	3000	WIDE	-	-	7000	■	GWR5253D30K	✓
111	I	✓	70	4000	WIDE	-	-	14800	■	GWR5713V	✓
Power LED dimmable DALI (5 Step) - 220-240 V 50/60 Hz											
111	II	✓	70	4000	WIDE	-	-	14800	■	GWR5213V	✓
77	II	✓	70	4000	WIDE	-	-	11000	■	GWR5273V	✓
Power LED dimmable 1-10 V 220-240 V 50/60 Hz											
111	II	✓	70	4000	WIDE	-	-	14800	■	GWR5213M	✓
111	II	✓	70	3000	WIDE	-	-	12800	■	GWR5213M30K	✓
77	II	✓	70	4000	WIDE	-	-	11000	■	GWR5273M	✓
77	II	✓	70	3000	WIDE	-	-	9500	■	GWR5273M30K	✓
55	II	✓	70	4000	WIDE	-	-	8100	■	GWR5253M	✓
111	I	✓	70	4000	WIDE	-	-	14800	■	GWR5713M	✓
111	I	✓	70	3000	WIDE	-	-	12800	■	GWR5713M30K	✓
77	I	✓	70	4000	WIDE	-	-	11000	■	GWR5773M	✓
77	I	✓	70	3000	WIDE	-	-	9500	■	GWR5773M30K	✓

ROAD [5] MEDIUM 3X3 LED HUGE

IP66 - IK08

LUMINAIRE WATTAGE (W)	CLASS	ENEC	CRI	KELVIN	OPTIC	BEAM ANGLE	LIGHTSOURCE LUMEN OUTPUT (lm)	LUMINAIRE LUMEN OUTPUT (lm)	COLOUR / FINISH	PART NUMBER	UKCA
Power LED 220-240 V 50/60 Hz											
111	II	✓	70	4000	HUGE	-	-	13900	■	GWR5113	✓
111	II	✓	70	3000	HUGE	-	-	12100	■	GWR511330K	✓
77	II	✓	70	4000	HUGE	-	-	10400	■	GWR5173	✓
77	II	✓	70	3000	HUGE	-	-	9000	■	GWR517330K	✓
111	I	✓	70	4000	HUGE	-	-	13900	■	GWR5613	✓
111	I	✓	70	3000	HUGE	-	-	12100	■	GWR561330K	✓
77	I	✓	70	4000	HUGE	-	-	10400	■	GWR5673	✓
77	I	✓	70	3000	HUGE	-	-	9000	■	GWR567330K	✓
Power LED automatic power reduction, bipower with self-learning - 220-240 V 50/60 Hz											
111	II	✓	70	4000	HUGE	-	-	13900	■	GWR5113B	✓
111	II	✓	70	3000	HUGE	-	-	12100	■	GWR5113B30K	✓
77	II	✓	70	4000	HUGE	-	-	10400	■	GWR5173B	✓
77	II	✓	70	3000	HUGE	-	-	9000	■	GWR5173B30K	✓
55	II	✓	70	4000	HUGE	-	-	7700	■	GWR5153B	✓
111	I	✓	70	4000	HUGE	-	-	13900	■	GWR5613B	✓
111	I	✓	70	3000	HUGE	-	-	12100	■	GWR5613B30K	✓
77	I	✓	70	4000	HUGE	-	-	10400	■	GWR5673B	✓
77	I	✓	70	3000	HUGE	-	-	9000	■	GWR5673B30K	✓
Power LED dimmable DALI (5 Step) - 220-240 V 50/60 Hz											
111	II	✓	70	4000	HUGE	-	-	13900	■	GWR5113V	✓
77	II	✓	70	4000	HUGE	-	-	10400	■	GWR5173V	✓
Power LED dimmable 1-10 V 220-240 V 50/60 Hz											
111	II	✓	70	4000	HUGE	-	-	13900	■	GWR5113M	✓
111	II	✓	70	3000	HUGE	-	-	12100	■	GWR5113M30K	✓
77	II	✓	70	4000	HUGE	-	-	10400	■	GWR5173M	✓
77	II	✓	70	3000	HUGE	-	-	9000	■	GWR5173M30K	✓
55	II	✓	70	4000	HUGE	-	-	7700	■	GWR5153M	✓
111	I	✓	70	4000	HUGE	-	-	13900	■	GWR5613M	✓
111	I	✓	70	3000	HUGE	-	-	12100	■	GWR5613M30K	✓
77	I	✓	70	4000	HUGE	-	-	10400	■	GWR5673M	✓
77	I	✓	70	3000	HUGE	-	-	9000	■	GWR5673M30K	✓



ROAD [5] MEDIUM 4X3 LED WIDE

IP66 - IK08



LUMINAIRE WATTAGE (W)	CLASS	ENEC	CRI	KELVIN	OPTIC	BEAM ANGLE	LIGHTSOURCE LUMEN OUTPUT (lm)	LUMINAIRE LUMEN OUTPUT (lm)	COLOUR / FINISH	PART NUMBER	UKCA
Power LED 220-240 V 50/60 Hz											
148	II	✓	70	4000	WIDE	-	-	19700	■	GWR5214	✓
148	II	✓	70	3000	WIDE	-	-	17100	■	GWR521430K	✓
102	II	✓	70	4000	WIDE	-	-	14600	■	GWR5274	✓
102	II	✓	70	3000	WIDE	-	-	12700	■	GWR527430K	✓
148	I	✓	70	4000	WIDE	-	-	19700	■	GWR5714	✓
148	I	✓	70	3000	WIDE	-	-	17100	■	GWR571430K	✓
102	I	✓	70	4000	WIDE	-	-	14600	■	GWR5774	✓
102	I	✓	70	3000	WIDE	-	-	12700	■	GWR577430K	✓
Power LED automatic power reduction, bipower with self-learning - 220-240 V 50/60 Hz											
148	II	✓	70	4000	WIDE	-	-	19700	■	GWR5214B	✓
148	II	✓	70	3000	WIDE	-	-	17100	■	GWR5214B30K	✓
102	II	✓	70	4000	WIDE	-	-	14600	■	GWR5274B	✓
102	II	✓	70	3000	WIDE	-	-	12700	■	GWR5274B30K	✓
73	II	✓	70	4000	WIDE	-	-	10800	■	GWR5254B	✓
148	I	✓	70	4000	WIDE	-	-	19700	■	GWR5714B	✓
148	I	✓	70	3000	WIDE	-	-	17100	■	GWR5714B30K	✓
102	I	✓	70	4000	WIDE	-	-	14600	■	GWR5774B	✓
102	I	✓	70	3000	WIDE	-	-	12700	■	GWR5774B30K	✓
Power LED dimmable DALI - 220-240 V 50/60 Hz											
73	II	✓	70	4000	WIDE	-	-	10800	■	GWR5254D	✓
73	II	✓	70	3000	WIDE	-	-	9400	■	GWR5254D30K	✓
Power LED dimmable DALI (5 Step) - 220-240 V 50/60 Hz											
148	II	✓	70	4000	WIDE	-	-	19700	■	GWR5214V	✓
102	II	✓	70	4000	WIDE	-	-	14600	■	GWR5274V	✓
Power LED dimmable 1-10 V 220-240 V 50/60 Hz											
148	II	✓	70	4000	WIDE	-	-	19700	■	GWR5214M	✓
148	II	✓	70	3000	WIDE	-	-	17100	■	GWR5214M30K	✓
102	II	✓	70	4000	WIDE	-	-	14600	■	GWR5274M	✓
102	II	✓	70	3000	WIDE	-	-	12700	■	GWR5274M30K	✓
73	II	✓	70	4000	WIDE	-	-	10800	■	GWR5254M	✓
148	I	✓	70	4000	WIDE	-	-	19700	■	GWR5714M	✓
148	I	✓	70	3000	WIDE	-	-	17100	■	GWR5714M30K	✓
102	I	✓	70	4000	WIDE	-	-	14600	■	GWR5774M	✓
102	I	✓	70	3000	WIDE	-	-	12700	■	GWR5774M30K	✓

ROAD [5] MEDIUM 4X3 LED HUGE

IP66 - IK08

LUMINAIRE WATTAGE (W)	CLASS	ENEC	CRI	KELVIN	OPTIC	BEAM ANGLE	LIGHTSOURCE LUMEN OUTPUT (lm)	LUMINAIRE LUMEN OUTPUT (lm)	COLOUR / FINISH	PART NUMBER	UKCA
Power LED 220-240 V 50/60 Hz											
148	II	✓	70	4000	HUGE	-	-	18600	■	GWR5114	✓
148	II	✓	70	3000	HUGE	-	-	16100	■	GWR511430K	✓
131	II	✓	70	3000	HUGE	-	-	14800	■	GWR517430K	✓
102	II	✓	70	4000	HUGE	-	-	13800	■	GWR5174	✓
148	I	✓	70	4000	HUGE	-	-	18600	■	GWR5614	✓
148	I	✓	70	3000	HUGE	-	-	16100	■	GWR561430K	✓
131	I	✓	70	3000	HUGE	-	-	14800	■	GWR567430K	✓
102	I	✓	70	4000	HUGE	-	-	13800	■	GWR5674	✓
Power LED automatic power reduction, bipower with self-learning - 220-240 V 50/60 Hz											
148	II	✓	70	4000	HUGE	-	-	18600	■	GWR5114B	✓
148	II	✓	70	3000	HUGE	-	-	16100	■	GWR5114B30K	✓
131	II	✓	70	3000	HUGE	-	-	14800	■	GWR5174B30K	✓
102	II	✓	70	4000	HUGE	-	-	13800	■	GWR5174B	✓
73	II	✓	70	4000	HUGE	-	-	10200	■	GWR5154B	✓
148	I	✓	70	4000	HUGE	-	-	18600	■	GWR5614B	✓
148	I	✓	70	3000	HUGE	-	-	16100	■	GWR5614B30K	✓
131	I	✓	70	3000	HUGE	-	-	14800	■	GWR5674B30K	✓
102	I	✓	70	4000	HUGE	-	-	13800	■	GWR5674B	✓
Power LED dimmable DALI (5 Step) - 220-240 V 50/60 Hz											
148	II	✓	70	4000	HUGE	-	-	18600	■	GWR5114V	✓
102	II	✓	70	4000	HUGE	-	-	13800	■	GWR5174V	✓
Power LED dimmable 1-10 V 220-240 V 50/60 Hz											
148	II	✓	70	4000	HUGE	-	-	18600	■	GWR5114M	✓
148	II	✓	70	3000	HUGE	-	-	16100	■	GWR5114M30K	✓
131	II	✓	70	3000	HUGE	-	-	14800	■	GWR5174M30K	✓
102	II	✓	70	4000	HUGE	-	-	13800	■	GWR5174M	✓
73	II	✓	70	4000	HUGE	-	-	10200	■	GWR5154M	✓
148	I	✓	70	4000	HUGE	-	-	18600	■	GWR5614M	✓
148	I	✓	70	3000	HUGE	-	-	16100	■	GWR5614M30K	✓
131	I	✓	70	3000	HUGE	-	-	14800	■	GWR5674M30K	✓
102	I	✓	70	4000	HUGE	-	-	13800	■	GWR5674M	✓



ROAD [5] MEDIUM 5X3 LED WIDE

IP66 - IK08



LUMINAIRE WATTAGE [W]	CLASS	ENEC	CRI	KELVIN	OPTIC	BEAM ANGLE	LIGHTSOURCE LUMEN OUTPUT (lm)	LUMINAIRE LUMEN OUTPUT (lm)	COLOUR / FINISH	PART NUMBER	UKCA
Power LED 220-240 V 50/60 Hz											
155	II	✓	70	4000	WIDE	-	-	21500	■	GWR5215	✓
155	II	✓	70	3000	WIDE	-	-	18700	■	GWR521530K	✓
127	II	✓	70	4000	WIDE	-	-	18300	■	GWR5275	✓
127	II	✓	70	3000	WIDE	-	-	15900	■	GWR527530K	✓
155	I	✓	70	4000	WIDE	-	-	21500	■	GWR5715	✓
155	I	✓	70	3000	WIDE	-	-	18700	■	GWR571530K	✓
127	I	✓	70	4000	WIDE	-	-	18300	■	GWR5775	✓
127	I	✓	70	3000	WIDE	-	-	15900	■	GWR577530K	✓
Power LED automatic power reduction, bipower with self-learning - 220-240 V 50/60 Hz											
155	II	✓	70	4000	WIDE	-	-	21500	■	GWR5215B	✓
155	II	✓	70	3000	WIDE	-	-	18700	■	GWR5215B30K	✓
127	II	✓	70	4000	WIDE	-	-	18300	■	GWR5275B	✓
127	II	✓	70	3000	WIDE	-	-	15900	■	GWR5275B30K	✓
91	II	✓	70	4000	WIDE	-	-	13500	■	GWR5255B	✓
155	I	✓	70	4000	WIDE	-	-	21500	■	GWR5715B	✓
155	I	✓	70	3000	WIDE	-	-	18700	■	GWR5715B30K	✓
127	I	✓	70	4000	WIDE	-	-	18300	■	GWR5775B	✓
127	I	✓	70	3000	WIDE	-	-	15900	■	GWR5775B30K	✓
Power LED dimmable DALI - 220-240 V 50/60 Hz											
91	II	✓	70	4000	WIDE	-	-	13500	■	GWR5255D	✓
91	II	✓	70	3000	WIDE	-	-	11700	■	GWR5255D30K	✓
Power LED dimmable DALI (5 Step) - 220-240 V 50/60 Hz											
155	II	✓	70	4000	WIDE	-	-	21500	■	GWR5215V	✓
127	II	✓	70	4000	WIDE	-	-	18300	■	GWR5275V	✓
Power LED dimmable 1-10 V 220-240 V 50/60 Hz											
155	II	✓	70	4000	WIDE	-	-	21500	■	GWR5215M	✓
155	II	✓	70	3000	WIDE	-	-	18700	■	GWR5215M30K	✓
127	II	✓	70	4000	WIDE	-	-	18300	■	GWR5275M	✓
127	II	✓	70	3000	WIDE	-	-	15900	■	GWR5275M30K	✓
91	II	✓	70	4000	WIDE	-	-	13500	■	GWR5255M	✓
155	I	✓	70	4000	WIDE	-	-	21500	■	GWR5715M	✓
155	I	✓	70	3000	WIDE	-	-	18700	■	GWR5715M30K	✓
127	I	✓	70	4000	WIDE	-	-	18300	■	GWR5775M	✓
127	I	✓	70	3000	WIDE	-	-	15900	■	GWR5775M30K	✓

ROAD [5] MEDIUM 5X3 LED HUGE

IP66 - IK08

LUMINAIRE WATTAGE (W)	CLASS	ENEC	CRI	KELVIN	OPTIC	BEAM ANGLE	LIGHTSOURCE LUMEN OUTPUT (lm)	LUMINAIRE LUMEN OUTPUT (lm)	COLOUR / FINISH	PART NUMBER	UKCA
Power LED 220-240 V 50/60 Hz											
155	II	✓	70	4000	HUGE	-	-	20300	■	GWR5115	✓
155	II	✓	70	3000	HUGE	-	-	17700	■	GWR511530K	✓
127	II	✓	70	4000	HUGE	-	-	17200	■	GWR5175	✓
127	II	✓	70	3000	HUGE	-	-	15000	■	GWR517530K	✓
155	I	✓	70	4000	HUGE	-	-	20300	■	GWR5615	✓
155	I	✓	70	3000	HUGE	-	-	17700	■	GWR561530K	✓
127	I	✓	70	4000	HUGE	-	-	17200	■	GWR5675	✓
127	I	✓	70	3000	HUGE	-	-	15000	■	GWR567530K	✓
Power LED automatic power reduction, bipower with self-learning - 220-240 V 50/60 Hz											
155	II	✓	70	4000	HUGE	-	-	20300	■	GWR5115B	✓
155	II	✓	70	3000	HUGE	-	-	17700	■	GWR5115B30K	✓
127	II	✓	70	4000	HUGE	-	-	17200	■	GWR5175B	✓
127	II	✓	70	3000	HUGE	-	-	15000	■	GWR5175B30K	✓
91	II	✓	70	4000	HUGE	-	-	12700	■	GWR5155B	✓
155	I	✓	70	4000	HUGE	-	-	20300	■	GWR5615B	✓
155	I	✓	70	3000	HUGE	-	-	17700	■	GWR5615B30K	✓
127	I	✓	70	4000	HUGE	-	-	17200	■	GWR5675B	✓
127	I	✓	70	3000	HUGE	-	-	15000	■	GWR5675B30K	✓
Power LED dimmable DALI (5 Step) - 220-240 V 50/60 Hz											
155	II	✓	70	4000	HUGE	-	-	20300	■	GWR5115V	✓
127	II	✓	70	4000	HUGE	-	-	17200	■	GWR5175V	✓
Power LED dimmable 1-10 V 220-240 V 50/60 Hz											
155	II	✓	70	4000	HUGE	-	-	20300	■	GWR5115M	✓
155	II	✓	70	3000	HUGE	-	-	17700	■	GWR5115M30K	✓
127	II	✓	70	4000	HUGE	-	-	17200	■	GWR5175M	✓
127	II	✓	70	3000	HUGE	-	-	15000	■	GWR5175M30K	✓
91	II	✓	70	4000	HUGE	-	-	12700	■	GWR5155M	✓
155	I	✓	70	4000	HUGE	-	-	20300	■	GWR5615M	✓
155	I	✓	70	3000	HUGE	-	-	17700	■	GWR5615M30K	✓
127	I	✓	70	4000	HUGE	-	-	17200	■	GWR5675M	✓
127	I	✓	70	3000	HUGE	-	-	15000	■	GWR5675M30K	✓



ROAD [5] MEDIUM 6X3 LED WIDE

IP66 - IK08



LUMINAIRE WATTAGE (W)	CLASS	ENEC	CRI	KELVIN	OPTIC	BEAM ANGLE	LIGHTSOURCE LUMEN OUTPUT (lm)	LUMINAIRE LUMEN OUTPUT (lm)	COLOUR / FINISH	PART NUMBER	UKCA
Power LED 220-240 V 50/60 Hz											
186	II	✓	70	4000	WIDE	-	-	25800	■	GWR5216	✓
186	II	✓	70	3000	WIDE	-	-	22400	■	GWR521630K	✓
153	II	✓	70	4000	WIDE	-	-	21900	■	GWR5276	✓
153	II	✓	70	3000	WIDE	-	-	19000	■	GWR527630K	✓
186	I	✓	70	4000	WIDE	-	-	25800	■	GWR5716	✓
186	I	✓	70	3000	WIDE	-	-	22400	■	GWR571630K	✓
153	I	✓	70	4000	WIDE	-	-	21900	■	GWR5776	✓
153	I	✓	70	3000	WIDE	-	-	19000	■	GWR577630K	✓
Power LED automatic power reduction, bipower with self-learning - 220-240 V 50/60 Hz											
186	II	✓	70	4000	WIDE	-	-	25800	■	GWR5216B	✓
186	II	✓	70	3000	WIDE	-	-	22400	■	GWR5216B30K	✓
153	II	✓	70	4000	WIDE	-	-	21900	■	GWR5276B	✓
153	II	✓	70	3000	WIDE	-	-	19000	■	GWR5276B30K	✓
109	II	✓	70	4000	WIDE	-	-	16200	■	GWR5256B	✓
186	I	✓	70	4000	WIDE	-	-	25800	■	GWR5716B	✓
186	I	✓	70	3000	WIDE	-	-	22400	■	GWR5716B30K	✓
153	I	✓	70	4000	WIDE	-	-	21900	■	GWR5776B	✓
153	I	✓	70	3000	WIDE	-	-	19000	■	GWR5776B30K	✓
Power LED dimmable DALI (5 Step) - 220-240 V 50/60 Hz											
186	II	✓	70	4000	WIDE	-	-	25800	■	GWR5216V	✓
153	II	✓	70	4000	WIDE	-	-	21900	■	GWR5276V	✓
Power LED dimmable 1-10 V 220-240 V 50/60 Hz											
186	II	✓	70	4000	WIDE	-	-	25800	■	GWR5216M	✓
186	II	✓	70	3000	WIDE	-	-	22400	■	GWR5216M30K	✓
153	II	✓	70	4000	WIDE	-	-	21900	■	GWR5276M	✓
153	II	✓	70	3000	WIDE	-	-	19000	■	GWR5276M30K	✓
109	II	✓	70	4000	WIDE	-	-	16200	■	GWR5256M	✓
186	I	✓	70	4000	WIDE	-	-	25800	■	GWR5716M	✓
186	I	✓	70	3000	WIDE	-	-	22400	■	GWR5716M30K	✓
153	I	✓	70	4000	WIDE	-	-	21900	■	GWR5776M	✓
153	I	✓	70	3000	WIDE	-	-	19000	■	GWR5776M30K	✓

ROAD [5] MEDIUM 6X3 LED HUGE

IP66 - IK08

LUMINAIRE WATTAGE (W)	CLASS	ENEC	CRI	KELVIN	OPTIC	BEAM ANGLE	LIGHTSOURCE LUMEN OUTPUT (lm)	LUMINAIRE LUMEN OUTPUT (lm)	COLOUR / FINISH	PART NUMBER	UKCA
Power LED 220-240 V 50/60 Hz											
186	II	✓	70	4000	HUGE	-	-	24400	■	GWR5116	✓
186	II	✓	70	3000	HUGE	-	-	21200	■	GWR511630K	✓
153	II	✓	70	4000	HUGE	-	-	20700	■	GWR5176	✓
153	II	✓	70	3000	HUGE	-	-	18000	■	GWR517630K	✓
186	I	✓	70	4000	HUGE	-	-	24400	■	GWR5616	✓
186	I	✓	70	3000	HUGE	-	-	21200	■	GWR561630K	✓
153	I	✓	70	4000	HUGE	-	-	20700	■	GWR5676	✓
153	I	✓	70	3000	HUGE	-	-	18000	■	GWR567630K	✓

Power LED automatic power reduction, bipower with self-learning - 220-240 V 50/60 Hz											
186	II	✓	70	4000	HUGE	-	-	24400	■	GWR5116B	✓
186	II	✓	70	3000	HUGE	-	-	21200	■	GWR5116B30K	✓
153	II	✓	70	4000	HUGE	-	-	20700	■	GWR5176B	✓
153	II	✓	70	3000	HUGE	-	-	18000	■	GWR5176B30K	✓
109	II	✓	70	4000	HUGE	-	-	15300	■	GWR5156B	✓
186	I	✓	70	4000	HUGE	-	-	24400	■	GWR5616B	✓
186	I	✓	70	3000	HUGE	-	-	21200	■	GWR5616B30K	✓
153	I	✓	70	4000	HUGE	-	-	20700	■	GWR5676B	✓
153	I	✓	70	3000	HUGE	-	-	18000	■	GWR5676B30K	✓

Power LED dimmable DALI (5 Step) - 220-240 V 50/60 Hz											
186	II	✓	70	4000	HUGE	-	-	24400	■	GWR5116V	✓
153	II	✓	70	4000	HUGE	-	-	20700	■	GWR5176V	✓

Power LED dimmable 1-10 V 220-240 V 50/60 Hz											
186	II	✓	70	4000	HUGE	-	-	24400	■	GWR5116M	✓
186	II	✓	70	3000	HUGE	-	-	21200	■	GWR5116M30K	✓
153	II	✓	70	4000	HUGE	-	-	20700	■	GWR5176M	✓
153	II	✓	70	3000	HUGE	-	-	18000	■	GWR5176M30K	✓
109	II	✓	70	4000	HUGE	-	-	15300	■	GWR5156M	✓
186	I	✓	70	4000	HUGE	-	-	24400	■	GWR5616M	✓
186	I	✓	70	3000	HUGE	-	-	21200	■	GWR5616M30K	✓
153	I	✓	70	4000	HUGE	-	-	20700	■	GWR5676M	✓
153	I	✓	70	3000	HUGE	-	-	18000	■	GWR5676M30K	✓



Optional accessories

DESCRIPTION	COLOR	PART NUMBER	UKCA
ROAD [5] MEDIUM			
Wall-mounting bracket 150x160x290 mm - graphite grey		GW86167	✓
Single pole head bracket 1 m - graphite grey		GW87581	✓
Double pole head bracket 1+1 m - graphite grey		GW87582	✓
Short bracket 0.5 m - graphite grey		GW87587	✓
Long bracket 1 m - graphite grey		GW87586	✓
Conical pole painted h = 5.5 m - graphite grey		GW84096	✓
Conical pole painted h = 6.8 m - graphite grey		GW87591	✓
Conical pole painted h = 7.8 m - graphite grey		GW84097	✓
Conical pole painted h = 8.8 m - graphite grey		GW87592	✓
Conical pole painted h = 9.8 m - graphite grey		GW87593	✓





STREET [O3]

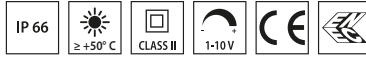

Scan the QR-code for the latest information

■ Graphite grey / Graphite grey /

- Street lighting device consisting of cover, frame and pole attachment in aluminium with low copper content die-casting
- PA6 side ventilation grills
 - Powder polyester coated after pre-treatment for increased corrosion resistance
 - Common mode surge protection up to 12kV according to IEC EN 61000-4-5 (issued by a third party) without the aid of additional protective devices
 - Optical system made with methacrylate lens, consisting of several different lenses that, with a single photometric distribution, and varying the installation parameters and the number of motors installed, allows the achievement of the obligatory road requirements
 - It can be used up to 50°C of ambient temperature but with reduced currents as indicated in the instruction manual



Municipality - Bellinzona - Switzerland

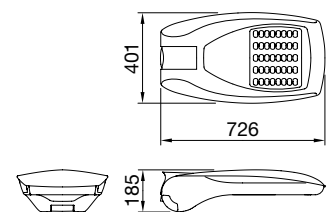

STREET [O3]

Identifying and classifying our optics

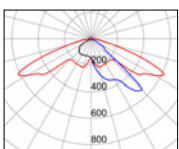

ST1-131 W-4000 K
180° — 90° — 270°

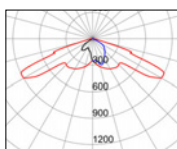

CYCLE-99 W-4000 K
180° — 90° — 270°

STREET [O3] ST1

IP66 - IK08

LUMINAIRE WATTAGE (W)	CLASS	ENEC	CRI	KELVIN	OPTIC	BEAM ANGLE	LIGHTSOURCE LUMEN OUTPUT (lm)	LUMINAIRE LUMEN OUTPUT (lm)	COLOUR / FINISH	PART NUMBER	UKCA
Power LED automatic power reduction, bipower with self-learning - 220-240 V 50/60 Hz											
129	II	✓	70	4000	ST1	-	-	13870	■	GW87534	✓
105	II	✓	70	4000	ST1	-	-	11240	■	GW87533	✓
81	II	✓	70	4000	ST1	-	-	8590	■	GW87532	✓
54	II	✓	70	4000	ST1	-	-	5890	■	GW87531	✓
31	II	✓	70	4000	ST1	-	-	3030	■	GW87530	✓
Power LED dimmable 1-10 V 220-240 V 50/60 Hz											
131	II	✓	70	4000	ST1	-	-	12900	■	GW87413	✓
127	II	✓	70	4000	ST1	-	-	13740	■	GW87414	✓
99	II	✓	70	4000	ST1	-	-	9860	■	GW87412	✓
68	II	✓	70	4000	ST1	-	-	6760	■	GW87411	✓
37	II	✓	70	4000	ST1	-	-	3470	■	GW87410	✓



STREET [O3] CYCLE

IP66 - IK08

LUMINAIRE WATTAGE (W)	CLASS	ENEC	CRI	KELVIN	OPTIC	BEAM ANGLE	LIGHTSOURCE LUMEN OUTPUT (lm)	LUMINAIRE LUMEN OUTPUT (lm)	COLOUR / FINISH	PART NUMBER	UKCA
Power LED dimmable 1-10 V 220-240 V 50/60 Hz											
99	II	✓	70	4000	CYCLE	-	-	9250	■	GWS7112	✓
68	II	✓	70	4000	CYCLE	-	-	6330	■	GWS7111	✓
37	II	✓	70	4000	CYCLE	-	-	3260	■	GWS7110	✓



Optional accessories

DESCRIPTION	COLOR	PART NUMBER	UKCA
STREET [O3]			
Wall-mounting bracket 150x160x290 mm - graphite grey		GW86167	✓
Single pole head bracket 1 m - graphite grey		GW87581	✓
Double pole head bracket 1+1 m - graphite grey		GW87582	✓
Short bracket 0.5 m - graphite grey		GW87587	✓
Long bracket 1 m - graphite grey		GW87586	✓
Conical pole painted h = 5.5 m - graphite grey		GW84096	✓
Conical pole painted h = 6.8 m - graphite grey		GW87591	✓
Conical pole painted h = 7.8 m - graphite grey		GW84097	✓
Conical pole painted h = 8.8 m - graphite grey		GW87592	✓
Conical pole painted h = 9.8 m - graphite grey		GW87593	✓



GEWISS S.p.A.

Via Domenico Bosatelli, 1
24069 Cenate Sotto (BG), Italia

T +39 035 946 111

E gewiss@gewiss.com

www.gewiss.com

